

Gluing equations for $\mathrm{PGL}(n, \mathbb{C})$ –representations of 3–manifolds

STAVROS GAROUFALIDIS
MATTHIAS GOERNER
CHRISTIAN K ZICKERT

Garoufalidis, Thurston and Zickert parametrized boundary-unipotent representations of a 3–manifold group into $\mathrm{SL}(n, \mathbb{C})$ using *Ptolemy coordinates*, which were inspired by \mathcal{A} –coordinates on higher Teichmüller space due to Fock and Goncharov. We parametrize representations into $\mathrm{PGL}(n, \mathbb{C})$ using *shape coordinates*, which are a 3–dimensional analogue of Fock and Goncharov’s \mathcal{X} –coordinates. These coordinates satisfy equations generalizing Thurston’s gluing equations. These equations are of Neumann–Zagier type and satisfy symplectic relations with applications in quantum topology. We also explore a duality between the Ptolemy coordinates and the shape coordinates.

57M27, 57N10; 53D50

1 Introduction

1.1 Thurston’s gluing equations

Thurston’s gluing equations are a system of polynomial equations defined for a compact 3–manifold M together with a topological ideal triangulation \mathcal{T} of the interior of M . The gluing equations were introduced to concretely construct a complete hyperbolic structure on M from a (suitable) solution to the gluing equations.

Although Thurston only considered manifolds whose boundary components are tori (a necessary condition for the existence of a solution yielding a hyperbolic structure), the gluing equations are defined for manifolds with arbitrary (possibly empty) boundary. The existence of hyperbolic structures is of no concern to us here.

The gluing equations consist of an *edge equation* for each 1–cell of \mathcal{T} and a *cuspidal equation* for each generator of the fundamental group of each boundary component of M . The system may be written in the form

$$(1-1) \quad \prod_j z_j^{A_{ij}} \prod_j (1 - z_j)^{B_{ij}} = \epsilon_i,$$

where A and B are matrices whose columns are parametrized by the simplices of \mathcal{T} and ϵ_i is a sign. Each variable z_j may be thought of as an assignment of an ideal simplex shape to a simplex of \mathcal{T} . If the shapes $z_j \in \mathbb{C} \setminus \{0, 1\}$ satisfy (1-1), as well as some extra conditions on the arguments of z_i , the ideal simplices glue together to form a complete hyperbolic structure on M . Ignoring the cusp equations gives structures that are incomplete. This gives rise to an efficient algorithm for constructing hyperbolic structures, which has been effectively implemented in software packages such as SnapPea [24], Snap [18], and SnapPy [3].

Among the numerous important features of the gluing equations we will focus on two:

- (a) The symplectic property of the exponent matrix $(A | B)$ of the gluing equations due to Neumann and Zagier [21].
- (b) The link to $\mathrm{PGL}(2, \mathbb{C})$ representations via a *developing map*

$$(1-2) \quad V_2(\mathcal{T}) \rightarrow \{\rho: \pi_1(M) \rightarrow \mathrm{PGL}(n, \mathbb{C})\} / \mathrm{Conj},$$

where $V_2(\mathcal{T})$ denotes the affine variety of solutions in $\mathbb{C} \setminus \{0, 1\}$ to the *edge* equations, and the right-hand side denotes the set of conjugacy classes of representations of $\pi_1(M)$ in $\mathrm{PGL}(2, \mathbb{C})$.

We may thus think of $V_2(\mathcal{T})$ as a parametrization of representations. Note, however, that $V_2(\mathcal{T})$ depends on the triangulation, and that the developing map need neither be onto nor finite-to-one. However, if the triangulation is sufficiently fine (a single barycentric subdivision suffices) the developing map is onto, ie every representation is detected (including reducible ones). A solution satisfying the cusp equations as well gives rise to a representation that is boundary-unipotent, ie takes peripheral curves to unipotent elements. Our goals are:

- To extend Thurston's gluing equations to $\mathrm{PGL}(n, \mathbb{C})$, preserving the above features for $n = 2$, using suitable shape parameters.
- To relate the Ptolemy parameters of Garoufalidis, Thurston and Zickert [16] to the shape parameters via a monomial map.

The Ptolemy and shape coordinates were inspired by the \mathcal{A} -coordinates and \mathcal{X} -coordinates on higher Teichmüller spaces due to Fock and Goncharov [12]. Note, however, that Fock and Goncharov study surfaces, whereas we study 3-manifolds. Shape coordinates for $n = 3$ have been studied independently by Bergeron, Falbel and Guilloux [1], and were also used by Falbel [8] and Falbel and Wang [11] in connection with spherical CR-structures.

There is a very interesting interplay between the shape coordinates and the Ptolemy coordinates. The groups $\mathrm{PGL}(n, \mathbb{C})$ and $\mathrm{SL}(n, \mathbb{C})$ are Langlands dual, and we believe that this interplay is a 3-dimensional aspect of the duality discussed for surfaces by Fock and Goncharov [12, page 33]. The duality is particularly explicit when all the boundary components of M are tori; see Proposition 12.3.

While the Ptolemy variety naturally parametrizes boundary-unipotent representations, the gluing equations parametrize the representations that are boundary-Borel, ie those that take peripheral curves to Borel subgroups. The boundary-unipotent ones can be determined by adding additional equations, which are generalizations of Thurston’s cusp equations. This is studied in Section 13.

1.2 Our main results

Given a topological ideal triangulation \mathcal{T} , each simplex of \mathcal{T} is divided into $\binom{n+1}{3}$ overlapping *subsimpllices* (see Definition 4.1) and each edge of each subsimplex is assigned a *shape parameter* (see Definition 4.2). These are the variables of the gluing equations. There is an equation for each nonvertex integral point of \mathcal{T} (see Definition 4.4). These are given in Definition 4.6.

We can write the gluing equations (without the cusp equations) in the form

$$(1-3) \quad \prod_s z_s^{A_{p,s}} \prod_s (1 - z_s)^{B_{p,s}} = \epsilon_p,$$

where ϵ_p is a sign, and A and B are matrices whose rows are parametrized by the nonvertex integral points p of \mathcal{T} and whose columns are parametrized by the subsimpllices s of \mathcal{T} .

Theorem 1.1 *Let $P = (A \mid B)$ be the concatenation of the matrices A and B in (1-3).*

- (a) *The rows of P Poisson commute, ie for any two rows v and w , $\langle v, w \rangle = 0$, where $\langle \cdot, \cdot \rangle$ is the symplectic form given by $\begin{pmatrix} 0 & I \\ -I & 0 \end{pmatrix}$.*
- (b) *If all boundary components of M are tori, P is an $r \times 2r$ matrix, where $r = t \binom{n+1}{3}$ and t is the number of simplices of \mathcal{T} .*

Remark 1.2 When $n = 2$, further symplectic properties (concerning the cusp equations and the rank of $(A \mid B)$) hold. The generalizations of these properties are addressed in Garoufalidis and Zickert [17].

Let $V_n(\mathcal{T})$ denote the affine variety of solutions to the $\mathrm{PGL}(n, \mathbb{C})$ gluing equations and let $P_n(\mathcal{T})$ denote the affine variety of solutions to the Ptolemy equations of Garoufalidis,

Thurston and Zickert [16] (see Section 5 for a review). The link to representations is given by the result below, which also gives the relationship between the shape coordinates and the Ptolemy coordinates.

Theorem 1.3 *There is a monomial map $\mu: P_n(\mathcal{T}) \rightarrow V_n(\mathcal{T})$ which fits in a commutative diagram*

$$(1-4) \quad \begin{array}{ccc} P_n(\mathcal{T}) & \xrightarrow{\mathcal{R}} & \left\{ \begin{array}{l} \rho: \pi_1(M) \rightarrow \mathrm{SL}(n, \mathbb{C}) \\ \text{boundary-unipotent} \end{array} \right\} / \mathrm{Conj} \\ \downarrow \mu & & \downarrow \pi \\ V_n(\mathcal{T}) & \xrightarrow{\mathcal{R}} & \left\{ \begin{array}{l} \rho: \pi_1(M) \rightarrow \mathrm{PGL}(n, \mathbb{C}) \\ \text{boundary-Borel} \end{array} \right\} / \mathrm{Conj} \end{array}$$

where the map π is induced by the canonical map $\mathrm{SL}(n, \mathbb{C}) \rightarrow \mathrm{PGL}(n, \mathbb{C})$. Furthermore, the horizontal maps are surjective if the triangulation \mathcal{T} is sufficiently fine.

Theorem 1.3 is an immediate consequence of Theorem 1.4 below, which displays some more of the underlying structure. Briefly, a *decoration* is an equivariant assignment of a coset to each vertex of each simplex of \mathcal{T} (see Definition 8.1) and a *cocycle* is an assignment of matrices to the edges satisfying the standard cocycle condition that the product around each face is 1 (see Definition 9.3). Generic decorations and natural cocycles are defined in Definition 8.5 and Definitions 9.12 and 9.13.

Theorem 1.4 *There is a commutative diagram*

$$(1-5) \quad \begin{array}{ccccc} \left\{ \begin{array}{l} \text{Ptolemy} \\ \text{assignments} \end{array} \right\} & \xleftarrow{\mathcal{C}} & \left\{ \begin{array}{l} \text{Generic} \\ \mathrm{SL}(n, \mathbb{C})/N \\ \text{decorations} \end{array} \right\} & \xrightarrow{\mathcal{L}_{\alpha\beta}} & \left\{ \begin{array}{l} \text{Natural} \\ (\mathrm{SL}(n, \mathbb{C}), N) \\ \text{cocycles} \end{array} \right\} \\ \downarrow \mu & & \downarrow \pi & & \downarrow \tau \\ \left\{ \begin{array}{l} \text{Shape} \\ \text{assignments} \end{array} \right\} & \xleftarrow{\mathcal{Z}} & \left\{ \begin{array}{l} \text{Generic} \\ \mathrm{PGL}(n, \mathbb{C})/B \\ \text{decorations} \end{array} \right\} & \xrightarrow{\mathcal{L}_{\alpha\beta\gamma}} & \left\{ \begin{array}{l} \text{Natural} \\ (\mathrm{PGL}(n, \mathbb{C}), B, H) \\ \text{cocycles} \end{array} \right\} \end{array}$$

in which the horizontal maps are one-to-one correspondences. All maps are explicit with explicit inverses and respect the symmetries of a simplex.

The fact that the top horizontal maps are one-to-one correspondences was proved in [16]. Explicit formulas for the cocycles are given in Proposition 10.4 and Theorem 10.14.

To see that Theorem 1.4 implies Theorem 1.3, note that a cocycle determines a representation by picking a base point and taking products along edge paths. Furthermore, a

decoration also determines (up to coboundaries) a G -cocycle in the dual triangulation of \mathcal{T} , which has an oriented edge for each face pairing. The last statement of Theorem 1.3 follows from Remark 8.6.

Remark 1.5 A triangulation with interior 0-cells (eg a triangulation of a closed manifold) can be regarded as an ideal triangulation of the manifold with boundary obtained by removing disjoint open balls around the interior 0-cells. Our techniques thus work for such triangulations as well. However, spherical boundary components make the dimension of the varieties blow up, so explicit computations are not practical. Furthermore, if some of the boundary components have negative Euler characteristic, being boundary-unipotent (or boundary-Borel) is a very restrictive condition. Hence, the most interesting case is the case where all boundary components are tori. This condition, however, is not necessary.

1.3 Computations and applications

The collection of gluing equations of an ideal triangulation is a standard object of SnapPy [3], which is used to study invariants of hyperbolic 3-manifolds. From the gluing equations, one can compute the so-called *Neumann–Zagier datum* of an ideal triangulation, which consists of the matrices $(A|B)$ defining the gluing equations, together with a shape solution z . There are three recent applications of the Neumann–Zagier datum in quantum topology: the quantum Riemann surfaces of Dimofte [4], the loop invariants of Dimofte and Garoufalidis [7] and the 3D index of Dimofte, Gaiotto and Gukov [5] (see also Garoufalidis [14]). These applications are reviewed in Section 7.2, and lead to exact computations.

Our generalized gluing equations for $\mathrm{PGL}(n, \mathbb{C})$ have been coded into SnapPy [3] by the second author and are available since version 1.7. As an application, we can define and efficiently compute the $\mathrm{PGL}(n, \mathbb{C})$ Neumann–Zagier datum of an ideal triangulation. Every function of the $\mathrm{PGL}(2, \mathbb{C})$ Neumann–Zagier datum can be evaluated at the $\mathrm{PGL}(n, \mathbb{C})$ Neumann–Zagier datum.

Even for $n = 2$, our results provide new data. Pre-existing software such as Snap-Pea [24], Snap [18] and SnapPy [3] all solve the gluing equations numerically (exact expressions can then be guessed using the LLL algorithm), but only give the shapes for the geometric representation. For the Ptolemy varieties exact computations are possible for $n = 2$ even when there are many simplices, and there are often several components of representations besides the geometric one.

Remark 1.6 Gröbner basis computations are feasible for the Ptolemy varieties even for many simplices, but they appear to be impractical for the gluing equations even when the

cuspidal equations are added. According to Fabrice Rouillier (private communication) this difference, however, is an artifact, which can easily be mitigated by slightly modifying the gluing equations. For a database of computations, see CURVE [9], and also Falbel, Koseleff and Rouillier [10].

1.4 Overview of the paper

In Section 2 we define the notion of a *concrete triangulation*, which is a triangulation together with a vertex ordering of each simplex. Two types of concrete triangulations are particularly important: *oriented* triangulations and *ordered* triangulations. In Section 3 we review Thurston's gluing equations, and in Section 4 we define the analogues for $n \geq 2$. The key notion is that of a *shape assignment*, which is defined first for a simplex and later for a triangulation. A shape assignment on a triangulation is a shape assignment on each simplex, such that the shapes satisfy the generalized gluing equations. In Section 5 we review the theory of Ptolemy coordinates developed in Garoufalidis, Thurston and Zickert [16], and in Section 6 we define a map μ from Ptolemy assignments to shape assignments. In Section 7 we prove Theorem 1.1 and discuss some applications in quantum topology. Sections 8–11 are devoted to proving Theorem 1.4. In Section 8, we briefly review the notion of a decoration, and define the maps \mathcal{C} and \mathcal{Z} in (1-5). In Section 9 we define the notion of a natural cocycle, and define the maps $\mathcal{L}_{\alpha\beta}$ and $\mathcal{L}_{\alpha\beta\gamma}$. In Section 10, we show that the natural cocycle of a decoration is given explicitly in terms of the shapes (or Ptolemy coordinates), and in Section 11 we show that the bottom maps of (1-5) are bijective, concluding the proof of Theorem 1.4. In Section 12 we discuss a duality between Ptolemy coordinates and shape coordinates, and in Section 13 we show how to add cuspidal equations to ensure that the representations are boundary-unipotent. Finally, in Section 14 we write down the gluing equations and cuspidal equations for the figure-eight knot complement for $n = 3$ and $n = 4$.

Remark 1.7 The $\mathrm{SL}(2, \mathbb{C})$ -Ptolemy varieties are often empty for the cusped census manifolds. Even though the geometric representation of a cusped hyperbolic manifold lifts to $\mathrm{SL}(2, \mathbb{C})$, no lift is boundary-unipotent, and often (nontrivial) boundary-unipotent $\mathrm{SL}(2, \mathbb{C})$ -representations don't exist. In [16], we also considered Ptolemy varieties for $\mathrm{pSL}(n, \mathbb{C}) = \mathrm{SL}(n, \mathbb{C}) / \pm I$, defined when n is even via an obstruction class in $H^2(M, \partial M; \mathbb{Z}/2\mathbb{Z})$. The primary purpose of this was to ensure that the image of the geometric representation under the unique irreducible representation $\mathrm{PSL}(2, \mathbb{C}) \rightarrow \mathrm{pSL}(n, \mathbb{C})$ is detected for all census manifolds (more generally, for triangulations where all edges are essential). In this paper we shall only consider the $\mathrm{SL}(n, \mathbb{C})$ -Ptolemy variety. One can develop all the theory using the

$\mathrm{pSL}(n, \mathbb{C})$ -Ptolemy varieties, but since our main interest here is in the shape coordinates (and for clarity of exposition), we shall not do this here.

Remark 1.8 In Garoufalidis, Thurston and Zickert [16] we defined the volume (in fact, complex volume) of a boundary-unipotent $\mathrm{SL}(n, \mathbb{C})$ -representation and gave an explicit formula using the Ptolemy coordinates. Similarly, one can define the volume of a decorated $\mathrm{PGL}(n, \mathbb{C})$ -representation by adding the volumes of each of the shapes. The volume is an invariant of a decorated $\mathrm{PGL}(n, \mathbb{C})$ -representation (in the sense of Remark 8.4), but we do not know if the volume is independent of the decoration. This is nontrivial even for $n = 2$, where it was first proved by Francaviglia [13]. We shall not deal with this here.

Acknowledgements The authors wish to thank Nathan Dunfield, Walter Neumann and Dylan Thurston for helpful comments. Stavros Garoufalidis was supported in part by NSF grants number DMS-11-05678 and DMS-14-06419 and Christian Zickert was supported in part by NSF grants number DMS-13-09088 and DMS 10-07054.

2 Concrete triangulations

In all of the following M denotes a compact, oriented 3-manifold with (possibly empty) boundary. Let \hat{M} be the space obtained from M by collapsing each boundary component of M to a point. An *ordered simplex* is a simplex together with an ordering of its vertices.

Definition 2.1 An *abstract triangulation* \mathcal{T} of M is an identification of \hat{M} with a space obtained from a finite collection of 3-simplices by gluing together pairs of faces via *face-pairings*, ie affine homeomorphisms. A *concrete triangulation* \mathcal{T} of M is an abstract triangulation together with a fixed identification of each 3-simplex with a standard ordered 3-simplex.

The advantage of a concrete triangulation is that each simplex inherits a vertex ordering from the standard simplex. This extra datum gives us a concrete indexing scheme for the vertices and edges and allows us to concretely write down defining equations for the gluing equation variety and the Ptolemy variety. An abstract triangulation can be thought of as an equivalence class of concrete triangulations under reordering. As we shall see, a reordering changes the varieties by canonical isomorphisms. Hence, they only depend on the abstract triangulation.

Note that the vertex ordering of each simplex induces an orientation, which may or may not agree with the orientation inherited from M .

Definition 2.2 A concrete triangulation of M is an *oriented triangulation* if the orientation of each simplex agrees with the orientation of M . A concrete triangulation of M is an *ordered triangulation* if the face-pairings are order-preserving. An abstract triangulation is *orderable* if it supports an ordered triangulation.

As we shall see, the shape coordinates are most conveniently expressed in terms of *oriented triangulations*, whereas the Ptolemy coordinates are most conveniently expressed in terms of *ordered triangulations*. Note that since M is assumed to be oriented, one can always order the vertices to make the triangulation oriented.

Remark 2.3 One can always obtain an orderable triangulation by performing a sequence of 2–3 moves and 1–4 moves. One can do this systematically in such a way that the total number of simplices is increased by at worst a factor of 6. Alternatively, a barycentric subdivision always provides an ordered triangulation by ordering vertices by codimension.

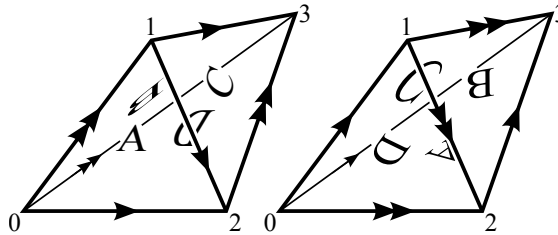

Figure 1: An ordered, but not oriented, triangulation of the figure-8 knot. No vertex ordering exists making the triangulation both ordered and oriented.

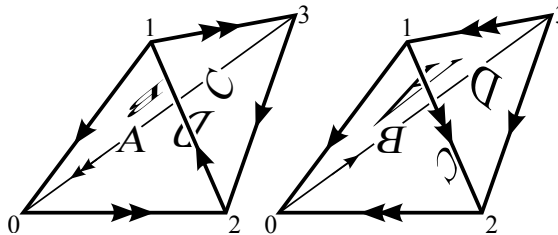

Figure 2: An oriented, but not ordered triangulation of the figure-8 knot sister. The underlying abstract triangulation is unorderable.

2.1 Face pairing permutations

We canonically identify the symmetry group of an ordered simplex with S_4 .

Definition 2.4 Let Δ_0 and Δ_1 be ordered simplices and let ψ from face f_0 of Δ_0 to face f_1 of Δ_1 be a face pairing. The *face pairing permutation* corresponding to ψ is the unique permutation $\sigma \in S_4$ such that ψ takes vertex v of Δ_0 to vertex $\sigma(v)$ of Δ_1 whenever v is a vertex in f_0 .

Note that if we identify Δ_0 and Δ_1 via the unique order-preserving isomorphism, σ is the unique extension of ψ to a symmetry of Δ_0 . See Figure 6.

3 Thurston’s gluing equations

In this section we briefly review Thurston’s gluing equations. For details we refer to Thurston [23] or Neumann and Zagier [21].

Let \mathcal{T} be an *oriented* triangulation of M . The gluing equations are given in terms of a variable $z_\Delta \in \mathbb{C} \setminus \{0, 1\}$, called a *shape coordinate*, for each simplex Δ of M . To define the equations, assign to each edge of each simplex Δ of M one of three *shape parameters*; see Figure 3. The shape parameters are given in terms of the shape coordinate z_Δ by

$$(3-1) \quad z_\Delta, \quad z'_\Delta = \frac{1}{1-z_\Delta}, \quad z''_\Delta = 1 - \frac{1}{z_\Delta} = -\frac{1-z_\Delta}{z_\Delta}.$$

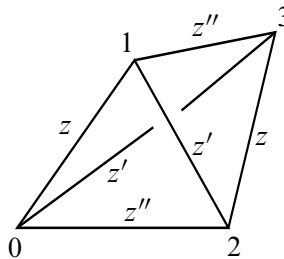

Figure 3: Assigning shape parameters to the edges of a simplex

The gluing equations consist of *edge equations* and *cuspidal equations*. There is an edge equation for each edge cycle e of \mathcal{T} , obtained by setting the product of the shape parameters assigned to each edge in e equal to 1. Each edge equation thus has the form

$$(3-2) \quad \prod_{\Delta} z_\Delta^{a_\Delta} \prod_{\Delta} z'_\Delta^{b_\Delta} \prod_{\Delta} z''_\Delta^{c_\Delta} = 1,$$

where a_Δ, b_Δ and c_Δ are integers.

The cuspidal equations consist of an equation for each generator of the fundamental group of each boundary component. If γ is a peripheral (normal) curve, we obtain a cuspidal

equation by setting the product of the shape parameters (or their inverses) of edges passed by γ equal to 1 (γ passes an edge E of a simplex Δ if it enters and exits Δ through faces intersecting in E). A shape parameter appears with its inverse if and only if γ passes e in a clockwise direction viewed from the cusp. The cusp equations have the same form as (3-2).

The following result is well known. We will generalize this to representations in $\text{PGL}(n, \mathbb{C})$ below.

Theorem 3.1 *A solution to the edge equations with all shape coordinates in $\mathbb{C} \setminus \{0, 1\}$ uniquely (up to conjugation) determines a representation $\rho: \pi_1(M) \rightarrow \text{PGL}(2, \mathbb{C})$. If the solution also satisfies the cusp equations, ρ is boundary-unipotent, ie takes peripheral curves to a conjugate of N .*

3.1 Symplectic properties of the gluing equations

It is sometimes convenient to express the gluing equations entirely in terms of the z_Δ . Using (3-1), we can rewrite (3-2) as

$$(3-3) \quad \prod_{\Delta} z_{\Delta}^{A_{\Delta}} \prod_{\Delta} (1 - z_{\Delta})^{B_{\Delta}} = \pm 1.$$

These equations are said to be of *Neumann–Zagier* type. Each such equation gives a row vector consisting of A_{Δ} and B_{Δ} . The resulting matrix has some symplectic properties.

4 Generalized gluing equations

In this section we define the higher-dimensional analog of Thurston’s edge equations. The generalized cusp equations will be studied in Section 13.

The idea is to subdivide each simplex of M into overlapping subsimplices, and assign a shape coordinate to each edge of each subsimplex. When the edge midpoints of different subsimplices intersect, we obtain a gluing equation by setting the product of the respective shape parameters equal to 1.

4.1 Simplex coordinates

We identify each simplex of a concrete triangulation \mathcal{T} with the ordered simplex

$$(4-1) \quad \Delta_n^3 = \{(x_0, x_1, x_2, x_3) \in \mathbb{R}^4 \mid 0 \leq x_i \leq n, x_0 + x_1 + x_2 + x_3 = n\}.$$

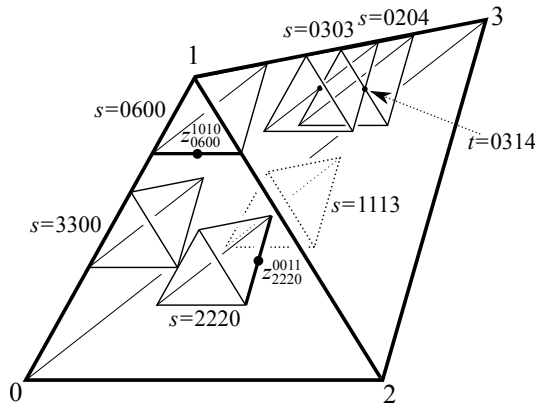

Figure 4: Subsimpllices and shape parameters for $n = 8$

By removing the four vertices, we obtain the ideal standard simplex $\dot{\Delta}_n^3$. Consider the sets

$$\Delta_n^3(\mathbb{Z}) = \Delta_n^3 \cap \mathbb{Z}^4, \quad \dot{\Delta}_n^3(\mathbb{Z}) = \dot{\Delta}_n^3 \cap \mathbb{Z}^4 \quad \text{and} \quad \Delta_n^3(\mathbb{Z}_+) = \Delta_n^3 \cap \mathbb{Z}_+^4$$

of integral points, nonvertex integral points, and integral points lying entirely inside the simplex. A simple counting argument shows that

$$(4-2) \quad |\Delta_n^3(\mathbb{Z})| = \binom{n+3}{3}, \quad |\dot{\Delta}_n^3(\mathbb{Z})| = \binom{n+3}{3} - 4 \quad \text{and} \quad |\Delta_n^3(\mathbb{Z}_+)| = \binom{n-1}{3}.$$

Note that $\dot{\Delta}_2^3(\mathbb{Z})$ consists of the edge midpoints of Δ_2^3 and thus naturally parametrizes the undirected edges.

When convenient, we abbreviate tuples by dropping the parentheses and the commas, eg we write 1010 instead of $(1, 0, 1, 0)$. Note that the indices of an edge and its opposite edge add up to 1111.

4.2 Symmetries of a simplex

The natural vertex ordering of Δ_n^3 induces an identification of the symmetry group of Δ_n^3 with S_4 , such that $\sigma \in S_4$ is the restriction to Δ_n^3 of the unique linear map taking the standard basis vector e_i to $e_{\sigma(i)}$, $i \in \{0, 1, 2, 3\}$. Note that σ extends to $\sigma : \Delta_n^3 \rightarrow \Delta_n^3$, $(x_0, x_1, x_2, x_3) \mapsto (x_{\sigma^{-1}(0)}, x_{\sigma^{-1}(1)}, x_{\sigma^{-1}(2)}, x_{\sigma^{-1}(3)})$.

4.3 Shape assignments

We now introduce the generalized shape parameters. We will need to replace the traditional labeling of the shape parameters z^l and z'' by a notation which better exhibits

the symmetry and naturally allows for a unified treatment of the gluing equations for all $n \geq 2$.

Definition 4.1 A subsimplex of Δ_n^3 is a subset S of Δ_n^3 obtained by translating $\Delta_2^3 \subset \mathbb{R}^4$ by an element s in $\Delta_{n-2}^3(\mathbb{Z}) \subset \mathbb{Z}^4$, ie $S = s + \Delta_2^3$.

Fix $n \geq 2$. We wish to assign shape parameters to each edge of each subsimplex. Note that the set of all these edges is naturally parametrized by the set $\Delta_{n-2}^3(\mathbb{Z}) \times \dot{\Delta}_2^3(\mathbb{Z})$, the first coordinate being the subsimplex and the second coordinate the edge.

Definition 4.2 A shape assignment on Δ_n^3 is an assignment

$$(4-3) \quad z: \Delta_{n-2}^3(\mathbb{Z}) \times \dot{\Delta}_2^3(\mathbb{Z}) \rightarrow \mathbb{C} \setminus \{0, 1\}, \quad (s, e) \mapsto z_s^e,$$

satisfying the *shape parameter relations*

$$(4-4a) \quad z_s^{0011} = z_s^{1100} = \frac{1}{1 - z_s^{0101}},$$

$$(4-4b) \quad z_s^{0110} = z_s^{1001} = \frac{1}{1 - z_s^{0011}},$$

$$(4-4c) \quad z_s^{0101} = z_s^{1010} = \frac{1}{1 - z_s^{0110}}.$$

Remark 4.3 When $n = 2$, there is only a single subsimplex indexed by $s = 0000$, so $\Delta_{n-2}^3(\mathbb{Z}) \times \dot{\Delta}_2^3(\mathbb{Z}) \cong \dot{\Delta}_2^3(\mathbb{Z})$ parametrizes the edges of a simplex. Since the shape parameters in (3-1) satisfy

$$z = \frac{1}{1 - z''}, \quad z' = \frac{1}{1 - z}, \quad z'' = \frac{1}{1 - z'},$$

Definition 4.2 generalizes Thurston’s shape assignments. The new notation relates to that of Thurston as follows:

$$z = z_s^{0011} = z_s^{1100}, \quad z' = z_s^{0110} = z_s^{1001}, \quad z'' = z_s^{0101} = z_s^{1010}.$$

4.4 Gluing equations for oriented triangulations

Let \mathcal{T} be an *oriented* triangulation. The gluing equations are indexed by (nonvertex) integral points of \mathcal{T} defined below and come in three flavors: *edge equations*, *face equations* and *interior equations*. In Section 4.6 we generalize the gluing equations to all concrete triangulations.

Recall that \mathcal{T} is an identification of \widehat{M} with a quotient of a disjoint union of standard simplices. Hence, \mathcal{T} comes naturally equipped with a map

$$(4-5) \quad q: \coprod \Delta_n^3 \rightarrow \widehat{M}.$$

Definition 4.4 An *integral point* of \mathcal{T} is a point p in

$$q\left(\coprod \Delta_n^3(\mathbb{Z})\right) \subset \widehat{M}.$$

We view p as an equivalence class of pairs (t, Δ) with $t \in \Delta_n^3(\mathbb{Z})$ and $\Delta \in \mathcal{T}$, and write $(t, \Delta) \in p$ if (t, Δ) is a representative of p . The set of all integral points of \mathcal{T} is denoted by $\mathcal{T}(\mathbb{Z})$.

Definition 4.5 Let p be an integral point of \mathcal{T} represented by (t, Δ) .

- (i) We call p a *vertex point* if t is a vertex of $\Delta_n^3(\mathbb{Z})$.
- (ii) We call p an *edge point* if t is on an edge of $\Delta_n^3(\mathbb{Z})$.
- (iii) We call p a *face point* if t is on a face $\Delta_n^3(\mathbb{Z})$.
- (iv) We call p an *interior point* if t is in the interior of $\Delta_n^3(\mathbb{Z})$, ie if $t \in \Delta_n^3(\mathbb{Z}_+)$.

We denote the set of nonvertex integral points by $\dot{\mathcal{T}}_n(\mathbb{Z})$.

Definition 4.6 A shape assignment on an ordered triangulation \mathcal{T} is a shape assignment $z_{s,\Delta}^e$ for each simplex $\Delta \in \mathcal{T}$ such that for each nonvertex integral point $p \in \dot{\mathcal{T}}_n(\mathbb{Z})$, the *generalized gluing equation*

$$(4-6) \quad \prod_{(t,\Delta) \in p} \prod_{t=s+e} z_{s,\Delta}^e = 1$$

is satisfied. The variety of shape assignments on \mathcal{T} is denoted by $V_n(\mathcal{T})$.

Note that the gluing equation for an integral point p sets equal to 1 the product of the shape parameters of all edges of subsimplices such that the edge midpoint intersects p . The generalized gluing equations come in three different flavors depending on the type of the integral point p .

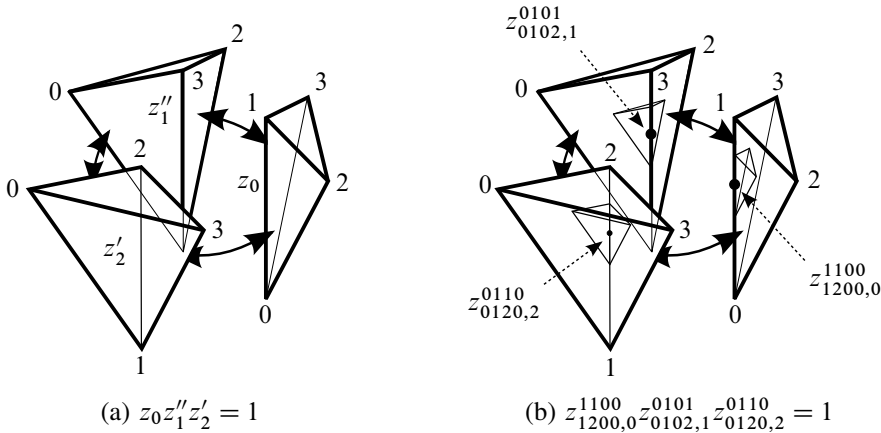

Figure 5: Edge equations for $n = 2$ (traditional notation) and $n = 5$

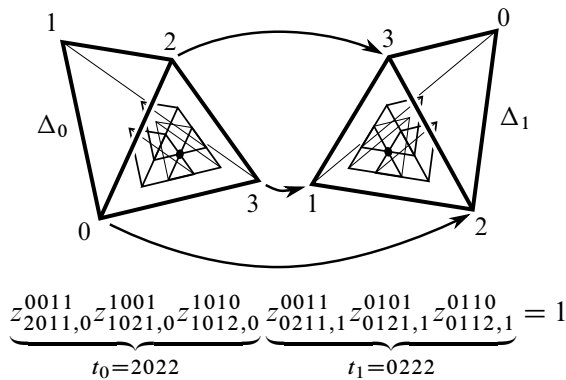

Figure 6: A face equation for $n = 6$. The indicated face-pairing is encoded by the permutation $\sigma = (0231) \in S_4$.

• **Edge equations** If p is an edge point, the equation is similar to the usual gluing equation in that the number of terms equals the length of the edge cycle. There are $n - 1$ edge gluing equations per edge of \mathcal{T} involving shape parameters at different levels. See Figure 5.

• **Face equations** If p is a face point, the product consists of six terms with three terms from each of the two simplices sharing the face. There are $\binom{n-1}{2}$ equations per face. See Figure 6.

• **Internal equations** If p is an interior point, the equation consists of six terms involving subsimplices of the same simplex, ie this equation is independent of the triangulation. There are $\binom{n-1}{3}$ equations per simplex. See Figure 7.

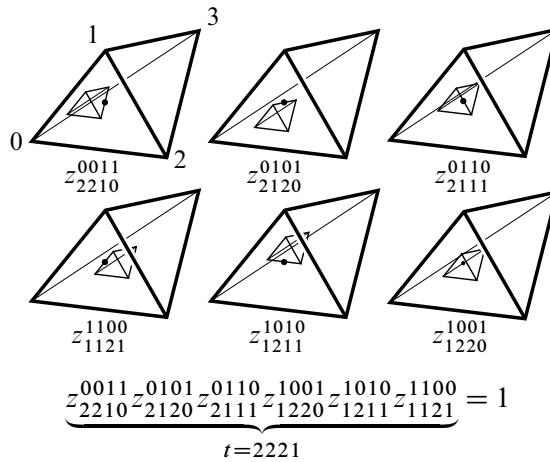

Figure 7: An internal equation for $n = 7$

Remark 4.7 There are no vertex equations. If p is a vertex point, (4-6) is tautologically satisfied since the product is empty.

4.5 The pullback of a shape assignment under a symmetry

Recall that we identify the symmetry group of Δ_n with S_4 .

Definition 4.8 Let $\sigma \in S_4$ and let $z: \Delta_{n-2}^3(\mathbb{Z}) \times \dot{\Delta}_2^3(\mathbb{Z}) \rightarrow \mathbb{C} \setminus \{0, 1\}$ be a map. The pullback of z under σ is the map given by

$$(4-7) \quad \sigma^* z: \Delta_{n-2}^3(\mathbb{Z}) \times \dot{\Delta}_2^3(\mathbb{Z}) \rightarrow \mathbb{C} \setminus \{0, 1\}, \quad (s, e) \mapsto (z_{\sigma(s)}^{\sigma(e)})^{\text{sgn} \sigma}.$$

The pullback obviously satisfies the standard properties $\tau^* \sigma^* = (\sigma \tau)^*$ and $\text{id}^* = \text{id}$.

Lemma 4.9 The pullback preserves shape assignments.

Proof Let z be a shape assignment. One easily checks that (4-4) is preserved under the A_4 action on the indices, so the result follows for $\sigma \in A_4$. Hence, all that remains is to prove the result for the permutation σ_{01} switching 0 and 1. The equation

$$(4-8) \quad (\sigma_{01}^* z)_s^{0011} = (\sigma_{01}^* z)_s^{1100} = \frac{1}{1 - (\sigma_{01}^* z)_s^{0101}}$$

is equivalent to

$$(4-9) \quad (z_{\sigma_{01}(s)}^{0011})^{-1} = (z_{\sigma_{01}(s)}^{1100})^{-1} = \frac{1}{1 - (z_{\sigma_{01}(s)}^{1001})^{-1}},$$

which follows from (4-4a) and (4-4b). The other equations are similarly verified. \square

Note that if $\sigma \in A_4$ is a rotation, the pullback σ^*z is the shape assignment obtained from z by rotating the simplex by σ . If σ is orientation-reversing, one must also replace all the shape parameters by their inverses.

Remark 4.10 We view the pullback of a shape assignment on an ordered simplex Δ as the natural induced shape assignment on the simplex Δ' obtained from Δ by reordering the vertices such that the i^{th} vertex of Δ' is the $\sigma(i)^{\text{th}}$ vertex of Δ .

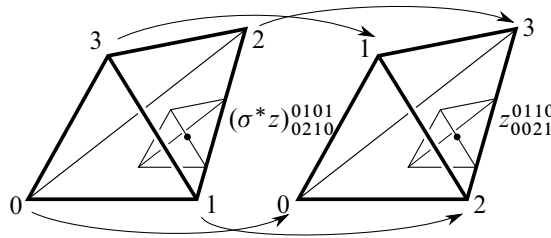

Figure 8: Reordering by $\sigma = (123)$

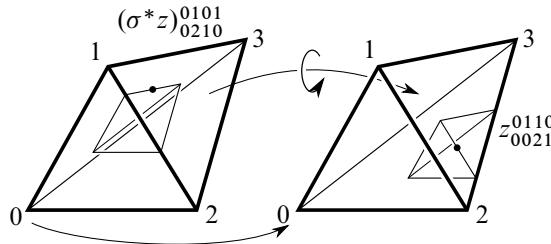

Figure 9: Pullback by $\sigma = (123)$

4.6 Gluing equations for general concrete triangulations

Since every concrete triangulation can be obtained from an oriented one by reordering some of the vertices, Lemma 4.9 motivates the following.

Definition 4.11 A shape assignment on a concrete triangulation \mathcal{T} is a shape assignment on each simplex such that

$$(4-10) \quad \prod_{(t,\Delta) \in p} \prod_{t=s+e} (z_{s,\Delta}^e)^{\epsilon_\Delta} = 1,$$

where ϵ_Δ is a sign indicating whether or not the orientation of Δ given by the vertex ordering agrees with the orientation inherited from M . The variety of shape assignments is denoted by $V_n(\mathcal{T})$.

The following is an immediate corollary of Lemma 4.9; see Remark 4.10.

Lemma 4.12 *Let $\{z_{\Delta_i}\}$ be a shape assignment on (M, \mathcal{T}) and let \mathcal{T}' be the triangulation obtained from \mathcal{T} by reordering each simplex Δ_i by a permutation $\sigma_i \in S_4$. The shape assignments $\{\sigma_i^* z_{\Delta_i}\}$ form a shape assignment on (M, \mathcal{T}') . \square*

Corollary 4.13 *Up to canonical isomorphism, the gluing equation variety only depends on the abstract triangulation. \square*

Remark 4.14 The gluing equations can also be defined if M is nonorientable: pick an oriented neighborhood U of the integer point p . The sign ϵ_{Δ} now indicates whether or not the orientation of Δ agrees with the orientation of U . We will not explore this further.

5 Review of Ptolemy coordinates

Ptolemy coordinates were introduced in [16] inspired by \mathcal{A} -coordinates on higher Teichmüller spaces due to Fock and Goncharov [12]. They are indexed by nonvertex integral points of \mathcal{T} satisfying *Ptolemy relations*, each involving the six Ptolemy coordinates assigned to the edges of a subsimplex. They are most naturally defined for ordered triangulations. General concrete triangulations are studied in Section 5.3.

5.1 Ptolemy assignments for ordered triangulations

Definition 5.1 A *Ptolemy assignment* on Δ_n^3 is an assignment

$$(5-1) \quad \dot{\Delta}_n^3(\mathbb{Z}) \rightarrow \mathbb{C} \setminus \{0\}, \quad t \mapsto c_t$$

of a nonzero complex number c_t to each nonvertex integral point t of Δ_n^3 such that the *Ptolemy relation*

$$(5-2) \quad c_{s+1001}c_{s+0110} + c_{s+1100}c_{s+0011} = c_{s+1010}c_{s+0101}$$

is satisfied for each subsimplex $s \in \Delta_{n-2}^3(\mathbb{Z})$.

Definition 5.2 A *Ptolemy assignment* on an *ordered* triangulation \mathcal{T} is an assignment

$$(5-3) \quad \dot{\mathcal{T}}_n(\mathbb{Z}) \rightarrow \mathbb{C} \setminus \{0\}, \quad p \mapsto c_p$$

of a nonzero complex number to each nonvertex integral point p of \mathcal{T} such that for each simplex in \mathcal{T} the identification with Δ_n^3 induces a Ptolemy assignment on Δ_n^3 . If $(t, \Delta) \in p$ is a representative of p , we write $c_{t, \Delta}$ for the Ptolemy coordinate c_p . The variety of Ptolemy assignments is denoted by $P_n(\mathcal{T})$.

Remark 5.3 Whenever convenient, we extend a Ptolemy assignment, so that it takes vertex points to 1.

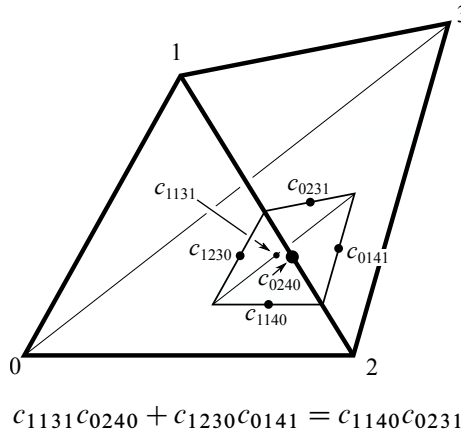

Figure 10: Ptolemy relation for the subsimplex $s = 0130$

Remark 5.4 Note that the Ptolemy relation (5-2) is local, ie independent of the triangulation \mathcal{T} . The triangulation determines whether (t, Δ) and (t', Δ') represent the same integral point p , and, hence, whether the Ptolemy coordinates $c_{t, \Delta}$ and $c_{t', \Delta'}$ are identified.

5.2 The pullback of a Ptolemy assignment under a symmetry

The Ptolemy coordinates are not as well-behaved under symmetries as the shapes. The pullback naively defined by $(\sigma^*c_t) = c_{\sigma(t)}$ does not preserve Ptolemy assignments. To fix this, we must modify by signs depending on both $\sigma \in S_4$ and t .

Let I denote the identity matrix in $GL(n, \mathbb{C})$. For each $t \in \Delta_n^3(\mathbb{Z})$, we can write I as a concatenation of $n \times t_i$ matrices I_i^t , ie we have $I = [I_0^t | I_1^t | I_2^t | I_3^t]$. For $\sigma \in S_4$ define

$$(5-4) \quad I_{\sigma, t} = [I_{\sigma(0)}^t | I_{\sigma(1)}^t | I_{\sigma(2)}^t | I_{\sigma(3)}^t].$$

Note that

$$(5-5) \quad I_{\sigma\tau, \sigma\tau(t)} = I_{\sigma, \sigma\tau(t)} I_{\tau, \tau(t)}, \quad \det I_{\sigma_{ij}, t} = \det I_{\sigma_{ij}, \sigma_{ij}(t)} = (-1)^{t_i t_j},$$

where σ_{ij} is the permutation switching i and j .

Definition 5.5 Let $\sigma \in S_4$ and let $c: \dot{\Delta}_n^3(\mathbb{Z}) \rightarrow \mathbb{C}^*$ be a map. The *pullback* of c under σ is the map

$$(5-6) \quad (\sigma^*c)_t = \det(I_{\sigma, \sigma(t)})c_{\sigma(t)}.$$

Using (5-5), one checks that the pullback satisfies the properties $\tau^*\sigma^* = (\sigma\tau)^*$ and $\mathrm{id}^* = \mathrm{id}$.

Remark 5.6 The formula is motivated by Lemma 8.9 below.

Remark 5.7 Note that $\det I_{\sigma, \sigma(t)}$ only depends on the parity of the entries of t (and on σ). It equals the sign of the permutation shuffling the odd entries of t ; eg if σ takes $t_0 = (0, 0, 3, 1)$ to $t_1 = (0, 1, 0, 3)$, $\det I_{\sigma, \sigma(t_0)} = -1$ since the permutation taking $(3, 1)$ to $(1, 3)$ is odd. See eg Figure 11.

Lemma 5.8 *The pullback preserves Ptolemy assignments.*

Proof Let $c: \dot{\Delta}_n^3 \rightarrow \mathbb{C}^*$ be a Ptolemy assignment. Since S_4 is generated by the transpositions σ_{01} , σ_{12} and σ_{23} , it is enough to prove the result for these. We prove it for σ_{01} , the others being similar. We wish to prove that

$$(5-7) \quad (\sigma_{01}^*c)_{s+1001}(\sigma_{01}^*c)_{s+0110} + (\sigma_{01}^*c)_{s+1100}(\sigma_{01}^*c)_{s+0011} - (\sigma_{01}^*c)_{s+1010}(\sigma_{01}^*c)_{s+0101} = 0.$$

Using (5-6) and (5-5) and letting $s' = \sigma_{01}s$, the left side of (5-7) becomes

$$(5-8) \quad \begin{aligned} & (-1)^{(s_0+1)s_1}(-1)^{s_0(s_1+1)}c_{s'+0101}c_{s'+1010} \\ & + (-1)^{(s_0+1)(s_1+1)}(-1)^{s_0s_1}c_{s'+1100}c_{s'+0011} \\ & - (-1)^{s_0(s_1+1)}(-1)^{s_1(s_0+1)}c_{s'+1001}c_{s'+0110} \\ & = (-1)^{s_0+s_1}(c_{s'+0101}c_{s'+1010} - c_{s'+1100}c_{s'+0011} - c_{s'+1001}c_{s'+0110}). \end{aligned}$$

By the Ptolemy relation for s' this equals 0, proving the result. □

As in Remark 4.10, we shall view the pullback as a natural induced Ptolemy assignment on a reordered simplex.

5.3 Ptolemy assignments for general concrete triangulations

For general concrete triangulations the Ptolemy coordinates on faces of different simplices must be identified by signs given by the face pairing permutations.

Definition 5.9 A Ptolemy assignment on (M, \mathcal{T}) is a Ptolemy assignment for each simplex of \mathcal{T} such that Ptolemy coordinates on identified faces are identified via the pullback of the permutation matrix. More precisely, if $f_0 \subset \Delta_0$ is paired with $f_1 \subset \Delta_1$ via the permutation σ , we require that

$$(5-9) \quad (\sigma^* c_{\Delta_1})_{t_0} = (c_{\Delta_0})_{t_0}$$

for each $t_0 \in \Delta_n^3$ on face f_0 . Equivalently, we require that

$$(5-10) \quad (c_{\Delta_0})_{t_0} = \det(I_{\sigma, \sigma(t_0)})(c_{\Delta_1})_{\sigma(t_0)}.$$

The variety of Ptolemy assignments is denoted by $P_n(\mathcal{T})$.

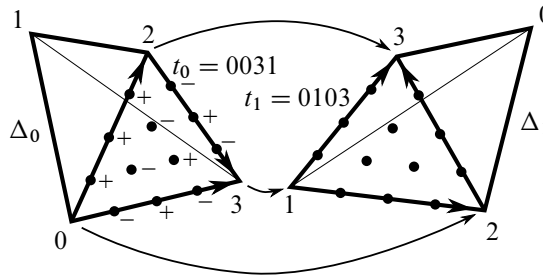

Figure 11: Identification of Ptolemy coordinates

Note that if \mathcal{T} is an ordered triangulation, all face pairings are order-preserving, so all signs are positive, and the definition agrees with Definition 5.1.

Lemma 5.10 Let \mathcal{T}' be the triangulation obtained from \mathcal{T} by reordering the vertices of Δ_i by a permutation σ_i . Then $\{\sigma_i^* c_{\Delta_i}\}$ is a Ptolemy cochain on \mathcal{T}' .

Proof We must prove that the coordinates on identified faces are identified via the pullback. Let $c_{\Delta'_i} = \sigma_i^* c_{\Delta_i}$. Suppose $f_i \subset \Delta_i$ is glued to $f_j \subset \Delta_j$ by a permutation τ . The corresponding face pairing involving Δ'_i and Δ'_j is then $\tau' = \sigma_j^{-1} \tau \sigma_i$. Since $\tau^* c_{\Delta_j}$ agrees with c_{Δ_i} on face f_0 , it follows from the standard pullback properties that $\tau'^* c_{\Delta'_j}$ and $c_{\Delta'_i}$ also agree on f_0 . This proves the result. \square

Corollary 5.11 Up to canonical isomorphism, the Ptolemy variety only depends on the abstract triangulation. \square

6 From Ptolemy coordinates to shapes

We now define a monomial map μ from Ptolemy assignments to shape assignments. Given a Ptolemy assignment c on a simplex Δ_n^3 , define $z: \Delta_{n-2}^3(\mathbb{Z}) \times \dot{\Delta}_2^3(\mathbb{Z}) \rightarrow \mathbb{C} \setminus \{0, 1\}$ by

$$(6-1) \quad \begin{aligned} z_s^{1100} &= z_s^{0011} = \frac{c_{s+1001}c_{s+0110}}{c_{s+1010}c_{s+0101}}, \\ z_s^{0110} &= z_s^{1001} = \frac{c_{s+0101}c_{s+1010}}{c_{s+1100}c_{s+0011}}, \\ z_s^{1010} &= z_s^{0101} = -\frac{c_{s+1100}c_{s+0011}}{c_{s+1001}c_{s+0110}}. \end{aligned}$$

Lemma 6.1 *The assignment (6-1) is a shape assignment, ie we have a well-defined map*

$$(6-2) \quad \mu: \{\text{Ptolemy assignments on } \Delta_n^3\} \rightarrow \{\text{shape assignments on } \Delta_n^3\}.$$

Proof Using the Ptolemy relation, we obtain

$$\begin{aligned} \frac{1}{1 - z_s^{0101}} &= \frac{1}{1 + \frac{c_{s+1100}c_{s+0011}}{c_{s+1001}c_{s+0110}}} = \frac{c_{s+1001}c_{s+0110}}{c_{s+1100}c_{s+0011} + c_{s+1001}c_{s+0110}} \\ &= \frac{c_{s+1001}c_{s+0110}}{c_{s+1010}c_{s+0101}} = z_s^{1100}. \end{aligned}$$

The other two equations in (4-4) follow similarly. □

Lemma 6.2 *The map μ respects pullbacks.*

Proof It is enough to prove this for the permutations σ_{01} , σ_{12} and σ_{23} . We prove it for σ_{01} , the other cases being similar. Since $\text{sgn } \sigma_{01} = -1$, we must prove that

$$(6-3) \quad (\mu(\sigma_{01}^*c))_s^e = (\mu(c)_{\sigma_{01}(s)}^e)^{-1}.$$

We prove this for the edge $e = 1100$, the other cases being similar. Using (5-8), we obtain

$$(6-4) \quad \begin{aligned} (\mu(\sigma_{01}^*c))_s^{1100} &= \frac{(\sigma_{01}^*c)_{s+1001}(\sigma_{01}^*c)_{s+0110}}{(\sigma_{01}^*c)_{s+1010}(\sigma_{01}^*c)_{s+0101}} \\ &= \frac{c_{s'+0101}c_{s'+1010}}{c_{s'+0110}c_{s'+1001}} = (\mu(c)_{s'}^{1100})^{-1}, \end{aligned}$$

where $s' = \sigma_{01}(s)$. This proves (6-3), hence the result. □

Theorem 6.3 *Let \mathcal{T} be a concrete triangulation of M and let $c_{t,\Delta}$ be a Ptolemy assignment on (M, \mathcal{T}) . The induced shape assignment on each simplex satisfies the generalized gluing equations and thus induces a shape assignment on (M, \mathcal{T}) . \square*

Corollary 6.4 *The map μ induces a map $\mu: P_n(\mathcal{T}) \rightarrow V_n(\mathcal{T})$. \square*

We divide the proof of Theorem 6.3 into three parts, one for each type of equation. The idea is to prove the result for the local model near an integral point of each type. Although the local model is not a manifold, Ptolemy assignments are defined in the obvious way, ie by identifying Ptolemy coordinates of identified faces via the pullback of the face pairing permutations.

6.1 Proof for edge equations

Let K be the space defined by cyclically gluing together k simplices $\Delta_0, \dots, \Delta_{k-1}$ along the common edge 01 , pairing all faces via the permutation (23); see left image in Figure 12.

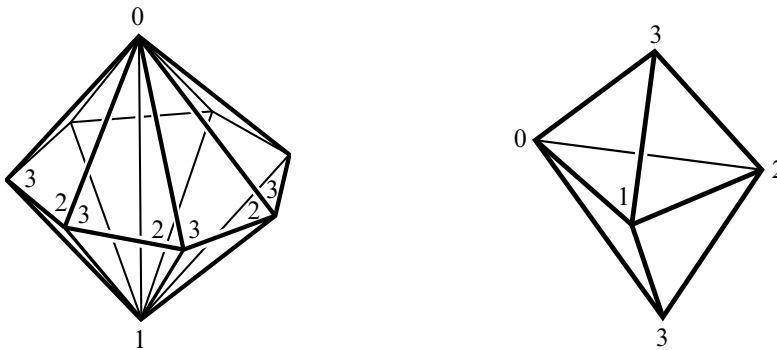

Figure 12: Left: local model near an edge point. Right: local model near a face point.

Lemma 6.5 *If $\{c_{\Delta_i}\}$ is a Ptolemy assignment on K , the assignments $\{\mu(c_{\Delta_i})\}$ satisfy the edge equations for all integral points on the edge 01 . The same holds for the complex K' obtained by reordering the vertices of the simplices of K .*

Proof An integral point p on 01 has representatives (t, Δ_i) with $t = (t_0, t_1, 0, 0)$ being fixed. The left-hand side of the edge equation for p is given by

$$(6-5) \quad z_{s,0}^{1100} z_{s,1}^{1100} \cdots z_{s,k-1}^{1100}, \quad \text{with } s = (t_0 - 1, t_1 - 1, 0, 0),$$

which expands to

$$\frac{c_{s+1001,0} c_{s+0110,0} c_{s+1001,1} c_{s+0110,1} \dots c_{s+1001,k-1} c_{s+0110,k-1}}{c_{s+1010,0} c_{s+0101,0} c_{s+1010,1} c_{s+0101,1} \dots c_{s+1010,k-1} c_{s+0101,k-1}}$$

Since the Ptolemy coordinates $c_{1001,i} = c_{1010,i+1}$ and $c_{0101,i} = c_{0110,i+1}$ on two adjacent simplices are identified, all terms cancel. Hence, (6-5) equals 1 as desired. The corresponding result for K' follows from compatibility under reordering (Lemmas 6.2, 4.12 and 5.10). \square

Corollary 6.6 *Theorem 6.3 holds for the edge equations.*

Proof The complex K models a neighborhood around an edge e of \mathcal{T} in the sense that there is a simplicial map $\pi: K \rightarrow \widehat{M}$ mapping 01 to e , which is unique up to changing the orientation of K and cyclically relabeling the simplices. By compatibility under reordering, we may assume that π is order-preserving. A Ptolemy assignment on \mathcal{T} pulls back to a Ptolemy assignment on K , such that edge equations on 01 descend to the corresponding edge equations on e . The result now follows from Lemma 6.5. \square

6.2 Proof for face equations

A local model for a neighborhood of a face point p is the complex K obtained by gluing two simplices Δ_0 and Δ_1 by identifying the faces 012 of each simplex in the order-preserving way; see the right image in Figure 12. As for the edge equations, it is enough to verify the face equations on K .

Lemma 6.7 *A Ptolemy assignment on K gives shape assignments satisfying the face equations. The same holds after reordering.*

Proof Let $t = (t_0, t_1, t_2, 0) = \alpha + 1110$, where α is a face point of Δ_{n-3}^3 . The representatives of the corresponding face point p of K are (t, Δ_0) and (t, Δ_1) . Since Δ_0 and Δ_1 have opposite orientations in K , the face equation for p involves the terms

$$(6-6) \quad z_{\alpha+1000,0}^{0110} z_{\alpha+0100,0}^{1010} z_{\alpha+0010,0}^{1100} (z_{\alpha+1000,1}^{0110} z_{\alpha+0100,1}^{1010} z_{\alpha+0010,1}^{1100})^{-1}.$$

Using (6-1), the product of the first three terms equals

$$(6-7) \quad \frac{c_{\alpha+2010,0} c_{\alpha+1101,0}}{c_{\alpha+2100,0} c_{\alpha+1011,0}} \left(-\frac{c_{\alpha+1200,0} c_{\alpha+0111,0}}{c_{\alpha+1101,0} c_{\alpha+0210,0}} \right) \frac{c_{\alpha+1011,0} c_{\alpha+0120,0}}{c_{\alpha+1020,0} c_{\alpha+0111,0}},$$

which simplifies to

$$(6-8) \quad -\frac{c_{\alpha+2010,0} c_{\alpha+1200,0} c_{\alpha+0120,0}}{c_{\alpha+2100,0} c_{\alpha+0210,0} c_{\alpha+1020,0}}.$$

Note that the ratio (6-8) only involves Ptolemy coordinates on the face 012 of Δ_0 and that these are identified with the corresponding Ptolemy coordinates on Δ_1 . Hence, (6-8) equals the corresponding expression for

$$(6-9) \quad z_{\alpha+1000,1}^{0110} z_{\alpha+0100,1}^{1010} z_{\alpha+0010,1}^{1100},$$

so (6-6) equals 1 as desired. The second statement follows from compatibility under reordering. □

Corollary 6.8 *Theorem 6.3 holds for the face equations.* □

Remark 6.9 The ratios (6-8) will reappear in later sections as X -coordinates. They agree with the X -coordinates considered by Fock and Goncharov [12].

6.3 Proof for internal equations

A local model near an interior point is a single simplex.

Lemma 6.10 *A Ptolemy assignment on Δ_n^3 gives rise to a shape assignment satisfying the internal gluing equations.*

Proof Let t be of the form $t = \alpha + 1111$ with $\alpha \in \Delta_{n-4}^3(\mathbb{Z})$. The gluing equation for t involves

$$(6-10) \quad z_{\alpha+1100}^{0011} z_{\alpha+1010}^{0101} z_{\alpha+1001}^{0110} z_{\alpha+0110}^{1001} z_{\alpha+0101}^{1010} z_{\alpha+0011}^{1100}.$$

When expanding this using (6-1), the two signs cancel and the numerator and denominator both consist of all Ptolemy coordinates $c_{\alpha+\beta}$ where β is a permutation of $(0, 1, 1, 2)$. Hence, the product is 1. □

Corollary 6.11 *Theorem 6.3 holds for the internal gluing equations.* □

7 Symplectic properties and quantum topology

7.1 Poisson commutation relations

In this section we prove Theorem 1.1. This is done by generalizing some of the combinatorial properties of triangulations studied by Neumann [20]. The first part is a consequence of Proposition 7.4 below, and the second part is an elementary counting argument. In a subsequent publication [17] we will study the full symplectic properties of the $\text{PGL}(n, \mathbb{C})$ -gluing equations, generalizing Neumann’s work [20] for $n = 2$.

In this section we assume for simplicity that the triangulation \mathcal{T} is oriented.

Letting

$$(7-1) \quad z_s = z_s^{1100} = z_s^{0011}, \quad z'_s = z_s^{0110} = z_s^{1001}, \quad z''_s = z_s^{1010} = z_s^{0101},$$

it follows immediately from Definition 4.6 that the gluing equations can be written as

$$(7-2) \quad \prod z_s^{A'_{p,s}} \prod (z'_s)^{B'_{p,s}} \prod (z''_s)^{C'_{p,s}} = 1$$

for integral matrices A' , B' and C' , whose rows are parametrized by the integral points of \mathcal{T} and whose columns are parametrized by the subsimplices of \mathcal{T} .

Since $z'_s = 1/(1 - z_s)$ and $z''_s = -(1 - z)/z$, we can write the gluing equations as

$$(7-3) \quad \prod z_s^{A_{p,s}} \prod (1 - z_s)^{B_{p,s}} = \epsilon_p,$$

where $A = A' - C'$, $B = C' - B'$ and ϵ_p is a sign. We wish to prove that the rows of $(A \mid B)$ Poisson commute.

Remark 7.1 One easily checks that ϵ_p is 1 if p is a face point or an interior point. If p is an edge point, ϵ_p is not 1 in general, but one can show that ϵ_p is 1 if the triangulation is ordered. We shall not need this here.

Recall that $\dot{\Delta}_2^3$ parametrizes the edges of Δ_2^3 . Let $J_{\Delta_2^3}$ be the abelian group generated by $\dot{\Delta}_2^3$ subject to the relations

$$(7-4a) \quad 1100 - 0011 = 1010 - 0101 = 1001 - 0110 = 0,$$

$$(7-4b) \quad 1100 + 0110 + 1010 = 0.$$

Relation (7-4a) states that opposite edges are equal, and (7-4b) states that the sum of the three edges meeting at a vertex is 0.

We endow $J_{\Delta_2^3}$ with the skew-symmetric bilinear form given by

$$(7-5) \quad \begin{aligned} \langle 1100, 0110 \rangle &= \langle 0110, 1010 \rangle = \langle 1010, 1100 \rangle = 1, \\ \langle 0110, 1100 \rangle &= \langle 1010, 0110 \rangle = \langle 1100, 1010 \rangle = -1. \end{aligned}$$

Note that $\langle \cdot, \cdot \rangle$ is nonsingular. Let

$$(7-6) \quad J_n(\mathcal{T}) = \bigoplus_{\Delta \in \mathcal{T}} \bigoplus_{s \in \Delta_{n-2}^3} J_{\Delta_2^3}$$

be a direct sum of copies of $J_{\Delta_2^3}$, one for each subsimplex of each simplex of \mathcal{T} . Note that $J_n(\mathcal{T})$ is generated by the set of all edges of all subsimplices of the simplices

of \mathcal{T} . We represent a generator as a tuple (Δ, s, e) . We extend the bilinear form $\langle \cdot, \cdot \rangle$ in the natural way, making the direct sum orthogonal.

Remark 7.2 When $n = 2$, $J_n(\mathcal{T})$ equals the space J considered by Neumann [20, Section 4].

Let $L_n(\mathcal{T})$ denote the free abelian group on the nonvertex integral points of \mathcal{T} . Consider the map

$$(7-7) \quad \beta: L_n(\mathcal{T}) \rightarrow J_n(\mathcal{T}), \quad p = \{(t, \Delta)\} \mapsto \sum_{(t, \Delta) \in p} \sum_{e+s=t} (\Delta, s, e).$$

Using (7-4a), we can write $\beta(p)$ as

$$(7-8) \quad \sum_{\substack{\Delta \in \mathcal{T} \\ s \in \Delta_{n-2}^3}} A'_{p,s}(\Delta, s, 1100) + \sum_{\substack{\Delta \in \mathcal{T} \\ s \in \Delta_{n-2}^3}} B'_{p,s}(\Delta, s, 0110) + \sum_{\substack{\Delta \in \mathcal{T} \\ s \in \Delta_{n-2}^3}} C'_{p,s}(\Delta, s, 1010),$$

where the entries of A' , B' and C' are all either 0, 1, or 2. Using (7-4b), this further simplifies to

$$(7-9) \quad \beta(p) = \sum_{\substack{\Delta \in \mathcal{T} \\ s \in \Delta_{n-2}^3}} A_{p,s}(\Delta, s, 1100) + \sum_{\substack{\Delta \in \mathcal{T} \\ s \in \Delta_{n-2}^3}} B_{p,s}(\Delta, s, 0110).$$

Note that the matrices A' , B' , C' , A and B are exactly those given by (7-2) and (7-3).

We identify $L_n(\mathcal{T})$ with its dual via the natural basis, and $J_n(\mathcal{T})$ with its dual via $\langle \cdot, \cdot \rangle$.

Lemma 7.3 *The dual $\beta^*: J_n(\mathcal{T}) \rightarrow L_n(\mathcal{T})$ of β is given by*

$$(7-10) \quad \begin{aligned} (\Delta, s, 1100) &\mapsto [(s + 1001, \Delta)] + [(s + 0110, \Delta)] \\ &\quad - [(s + 1010, \Delta)] - [(s + 0101, \Delta)], \\ (\Delta, s, 0110) &\mapsto [(s + 1010, \Delta)] + [(s + 0101, \Delta)] \\ &\quad - [(s + 1100, \Delta)] - [(s + 0011, \Delta)], \\ (\Delta, s, 1010) &\mapsto [(s + 1100, \Delta)] + [(s + 0011, \Delta)] \\ &\quad - [(s + 1001, \Delta)] - [(s + 0110, \Delta)], \end{aligned}$$

where $[(t, \Delta)]$ denotes the integral point determined by (t, Δ) .

Proof This is an immediate consequence of (7-9) and (7-5). □

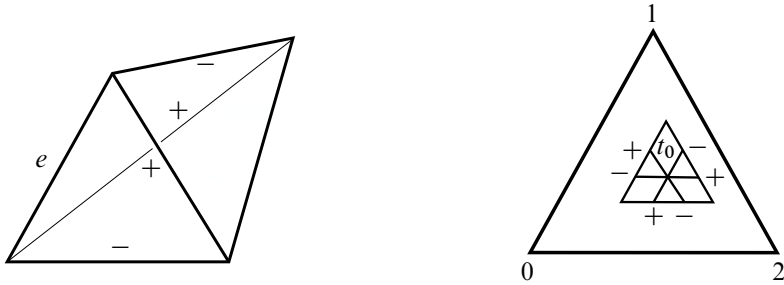

Figure 13: Left: the signs of the terms in $\beta^*(\Delta, s, e)$. Right: the signs of the terms in $\beta^* \circ \beta([\Delta_0, t_0])$ coming from Δ_0 .

One can view the map geometrically as in the left image in Figure 13. The orientation of Δ determines which signs are positive.

The elements $(\Delta, s, 1100)$ and $(\Delta, s, 0110)$ provide a basis for $J_n(\mathcal{T})$. We fix an ordering such that $(\Delta, s, 1100) > (\Delta, s, 0110)$. In this basis, the form $\langle \cdot, \cdot \rangle$ becomes the standard symplectic form on \mathbb{Z}^{2r} given by $\begin{pmatrix} 0 & I \\ -I & 0 \end{pmatrix}$.

Proposition 7.4 *We have a chain complex*

$$(7-11) \quad L_n(\mathcal{T}) \xrightarrow{\beta} J_n(\mathcal{T}) \xrightarrow{\beta^*} L_n(\mathcal{T}),$$

ie the map $\beta^* \circ \beta$ is zero. The matrix representation of β is the transpose of $(A \mid B)$, and the matrix representation of β^* is the transpose of the coefficient matrix of the monomial map μ relating the Ptolemy coordinates and the shapes.

Proof The proof is similar (in some sense dual) to the proof of Theorem 6.3. Let $p = \{(\Delta_0, t_0), \dots, (\Delta_k, t_k)\}$ be an edge point. Let s_i be the unique subsimplex of Δ_i having t_i as an edge point. The triangulation induces a gluing of the simplices s_i along a common edge, as in the left image in Figure 12. Viewed from the top, this configuration looks like Figure 14. The signs indicated are the signs of the integral points involved in $\beta^* \circ \beta(p)$. It follows that all signs cancel out.

Let $p = \{(\Delta_0, t_0), (\Delta_1, t_1)\}$ be a face point. For simplicity we assume that $t_0 = \alpha + 1110$ is on the face opposite vertex 3 of Δ_0 (the other cases are similar). Then t_0 is an edge point of exactly three subsimplices: $s_1 = \alpha + 0010$, $s_2 = \alpha + 1000$ and $s_3 = \alpha + 0100$. The terms of $\beta(p)$ coming from (Δ_0, t_0) are then

$$(7-12) \quad (\Delta_0, s_1, 1100) + (\Delta_0, s_2, 0110) + (\Delta_0, s_3, 1010).$$

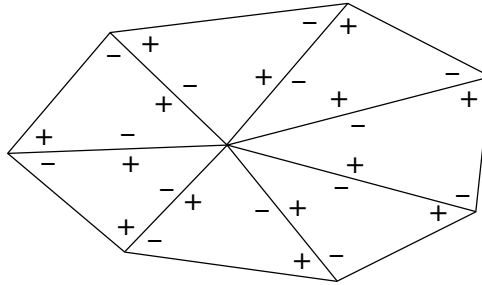

Figure 14: Cancellation of terms in $\beta^* \circ \beta(p)$ for an edge point p

For the next two displays we shall write $[t]$ instead of $[(t, \Delta_0)]$, the simplex Δ_0 being fixed. Applying β^* to (7-12), we obtain

$$(7-13) \quad \begin{aligned} & [s_1 + 1001] + [s_1 + 0110] - [s_1 + 1010] - [s_1 + 0101] \\ & + [s_2 + 1010] + [s_2 + 0101] - [s_2 + 1100] - [s_2 + 0011] \\ & + [s_3 + 1100] + [s_3 + 0011] - [s_3 + 1001] - [s_3 + 0110], \end{aligned}$$

which equals

$$(7-14) \quad [\alpha + 2010] + [\alpha + 1200] + [\alpha + 0120] - [\alpha + 2100] - [\alpha + 0210] - [\alpha + 1020].$$

Note that all terms are integral points lying on the same face as t_0 . The signs are indicated in the right image in Figure 13. Since \mathcal{T} is oriented, the terms arising from (Δ_1, t_1) are the same, but appear with opposite signs. Hence, they cancel out. Let $p = \{(t, \Delta)\}$ be an interior point, where $t = \alpha + 1111$. We have

$$(7-15) \quad \begin{aligned} \beta(p) = & (\Delta, \alpha + 1100, 0011) + (\Delta, \alpha + 0110, 1001) + (\Delta, \alpha + 1010, 0101) \\ & + (\Delta, \alpha + 0011, 1100) + (\Delta, \alpha + 1001, 0110) + (\Delta, \alpha + 1100, 0011). \end{aligned}$$

As in the proof of Lemma 6.10, the positive and negative terms of $\beta^* \circ \beta(p)$ both consist of all terms $[(\alpha + \beta, \Delta)]$, where β is a permutation of $(0, 1, 1, 2)$. Hence, all terms cancel out.

The last statement follows from (7-9), and by comparing (7-10) and (6-1). □

Corollary 7.5 *The rows of $(A | B)$ Poisson commute.* □

Lemma 7.6 *If all the boundary components of M are tori, the number of nonvertex integral points of \mathcal{T} equals $t \binom{n+1}{3}$.*

Proof Let e , f , and t denote the number of edges, faces and simplices of \mathcal{T} . Since all boundary components are tori, a simple Euler characteristic argument shows that $e = \frac{1}{2}f = t$. Using this, we have

$$(7-16) \quad |\dot{\mathcal{T}}_n(\mathbb{Z})| = (n-1)e + \frac{(n-1)(n-2)}{2}f + \frac{(n-1)(n-2)(n-3)}{6}t = t \binom{n+1}{3},$$

as desired. □

Corollary 7.7 *If all the boundary components of M are tori, the matrix $(A \mid B)$ is $r \times 2r$, where $r = t \binom{n+1}{3}$ and t is the number of simplices of \mathcal{T} .*

Proof By Lemma 7.6, the number of rows equals r . The number of columns equals $2t|\Delta_{n-2}^3(\mathbb{Z})|$, which by (4-2) equals $2t \binom{n+1}{3} = 2r$. □

This concludes the proof of Theorem 1.1.

7.2 Applications in quantum topology

Recently, ideal triangulations \mathcal{T} of 3-manifolds and their gluing equations have been used to construct interesting quantum invariants of 3-manifolds, and the extension of these invariants to the setting of $\mathrm{PGL}(n, \mathbb{C})$ -representations has been a main motivation for our work. We will list three types of invariants here, and refer to the literature for more details:

- (a) The *quantum Riemann surfaces* of Dimofte [4].
- (b) The *loop invariants* of Dimofte and Garoufalidis [7].
- (c) The *3D index* of Dimofte, Gaiotto and Gukov [6; 5], Garoufalidis [14] and Garoufalidis, Hodgson, Rubinstein and Segerman [15].

The input of [4] is an ideal triangulation \mathcal{T} of a 3-manifold with torus boundary components, and the output is a polynomial in q -commuting variables (one per meridian and longitude of each torus boundary component). The operators generate a q -holonomic ideal which depends on \mathcal{T} and ought to map to the gluing equation variety $V_2(\mathcal{T})$ when $q = 1$.

The input of [7] is a Neumann–Zagier datum which consists of an ideal triangulation together with a solution of the gluing equations whose image under the map (1-2) is the discrete faithful representation of M . The output is a formal power series in a variable \hbar with coefficients rational functions on the image of the map (1-2). The coefficient of \hbar in this series ought to agree with the nonabelian torsion of Porti [22]

and the evaluation of the series at the discrete faithful representation when $\hbar = 2\pi i/N$, ought to agree to all orders in $1/N$ with the asymptotics of the Kashaev invariant [19] of a hyperbolic knot complement. It was shown in [7, Proposition 1.7] that the coefficient of \hbar (the so-called 1-loop invariant) is a topological invariant of cusped hyperbolic 3-manifolds. It is conjectured that the above formal power series is a topological invariant of cusped hyperbolic 3-manifolds.

The input of the 3D index of [6; 5] is an ideal triangulation \mathcal{T} which supports a strict angle structure. The output is a q -holonomic function $I_{\mathcal{T}}: \mathbb{Z}^{2r} \rightarrow \mathbb{Z}((q^{1/2}))$, where r is the number of torus boundary components of M and $\mathbb{Z}((q^{1/2}))$ is the ring of Laurent series in q with integer coefficients. Convergence of this q -series holds exactly for those ideal triangulations \mathcal{T} that support an index structure [14], or, equivalently [15, Theorem 1.2], for those ideal triangulations which are 1-efficient. In addition, the 3D index $I_{\mathcal{T}}$ is an invariant of cusped hyperbolic 3-manifolds [15, Theorems 1.8 and 1.9].

Theorems 1.1 and 1.3, and the upcoming work [17], allow us to extend the loop invariants and the 3D index to the setting of $\mathrm{PGL}(n, \mathbb{C})$ -representations. This extension will be discussed in a future publication.

8 Decorations

We refer to Garoufalidis, Thurston and Zickert [16] or Zickert [25] for more details on decorations. Let G be a group and H a subgroup of G .

Definition 8.1 Let Δ be an ordered k -simplex. A G/H -decoration of Δ is an assignment of a left H -coset to each vertex of Δ . We only consider decorations up to G -action, ie we consider two decorations to be equal if they differ by left multiplication by an element in G . We represent a decoration by a tuple (g_0H, \dots, g_kH) .

If G and H are clear from the context, we refer to a G/H -decoration as a decoration.

Definition 8.2 A decoration on \mathcal{T} is an assignment of G/H -cosets to the vertices of \widehat{M} which is equivariant with respect to some representation $\rho: \pi_1(M) \rightarrow G$. If ρ is given, we shall refer to the decoration as a *decoration of ρ* .

Note that left multiplication of all the cosets of a decoration of ρ by an element $g \in G$ yields a decoration of $g\rho g^{-1}$. Hence, we shall only consider decorations up to left multiplication.

Remark 8.3 Every (G, H) -representation $\rho: \pi_1(M) \rightarrow G$ has a decoration.

Remark 8.4 A representation determines a flat bundle E over M . One can show [16, Proposition 4.6] that a decoration corresponds to a reduction of the restriction of E to ∂M to a flat H -bundle. Two decorations determine the same reduction if and only if they are *equivalent* in the sense of [16, Definition 4.4]. We shall not need this here.

8.1 Generic decorations, Ptolemy coordinates and shapes

For an element $g \in \mathrm{GL}(n, \mathbb{C})$, let $\{g\}_i$ denote the ordered set consisting of the first i column vectors of g .

Definition 8.5 A $\mathrm{GL}(n, \mathbb{C})/N$ -decoration (g_0N, g_1N, g_2N, g_3N) on Δ_n^3 is *generic* if, for each $(t_0, t_1, t_2, t_3) \in \Delta_n^3(\mathbb{Z})$,

$$(8-1) \quad \det(\{g_0\}_{t_0} \cup \{g_1\}_{t_1} \cup \{g_2\}_{t_2} \cup \{g_3\}_{t_3}) \neq 0.$$

Genericity of $\mathrm{PGL}(n, \mathbb{C})/B$ -decorations is defined similarly.

The definition is obviously independent of the choice of coset representatives, and of the ordering of the tuple.

Remark 8.6 Although all boundary-Borel representations can be decorated, some representations may only have nongeneric decorations. However, after a single barycentric subdivision, every representation has a generic decoration. For $\mathrm{SL}(n, \mathbb{C})/N$ -decorations this is proved in [16, Proposition 5.4], and the proof for $\mathrm{PGL}(n, \mathbb{C})/B$ -decorations is similar. This proves the last statement of Theorem 1.3.

Lemma 8.7 (Fock and Goncharov [12, Lemma 10.3]; see also [16]) *A generic $\mathrm{GL}(n, \mathbb{C})/N$ -decoration (g_0N, g_1N, g_2N, g_3N) of Δ_n^3 induces a Ptolemy assignment*

$$(8-2) \quad c: \dot{\Delta}_n^3(\mathbb{Z}) \rightarrow \mathbb{C}^*, \quad t \mapsto \det(\{g_0\}_{t_0} \cup \{g_1\}_{t_1} \cup \{g_2\}_{t_2} \cup \{g_3\}_{t_3}). \quad \square$$

Corollary 8.8 *We have a map*

$$(8-3) \quad \mathcal{C}: \{\text{Generic } \mathrm{GL}(n, \mathbb{C})/N\text{-decorations on } \Delta_n^3\} \\ \rightarrow \{\text{Ptolemy assignments on } \Delta_n^3\}. \quad \square$$

Note that \mathcal{C} is invariant under the left action by $\mathrm{SL}(N, \mathbb{C})$.

Lemma 8.9 *The map \mathcal{C} is compatible with pullbacks, ie*

$$(8-4) \quad \sigma^*(\mathcal{C}(g_0N, g_1N, g_2N, g_3N)) = \mathcal{C}(g_{\sigma(0)}N, g_{\sigma(1)}N, g_{\sigma(2)}N, g_{\sigma(3)}N).$$

Proof Let

$$(8-5) \quad c = \mathcal{C}(g_0N, g_1N, g_2N, g_3N) \text{ and } c' = \mathcal{C}(g_{\sigma(0)}N, g_{\sigma(1)}N, g_{\sigma(2)}N, g_{\sigma(3)}N).$$

Then

$$(8-6) \quad c_{\sigma(t)} = \det\left(\bigcup_{i=0}^3 \{g_i\}_{t_{\sigma^{-1}(i)}}\right), \quad c'_t = \det\left(\bigcup_{i=0}^3 \{g_{\sigma(i)}\}_{t_i}\right).$$

One easily checks that

$$(8-7) \quad \left(\bigcup_{i=0}^3 \{g_i\}_{t_{\sigma^{-1}(i)}}\right) I_{\sigma, \sigma(t)} = \bigcup_{i=0}^3 \{g_{\sigma(i)}\}_{t_i},$$

from which it follows that $(\sigma^*c)_t = c_{\sigma(t)} \det I_{\sigma, \sigma(t)} = c'_t$. This proves the result. \square

Corollary 8.10 *A generic $SL(n, \mathbb{C})/N$ -decoration on (M, \mathcal{T}) induces a Ptolemy assignment on (M, \mathcal{T}) .*

Proof We only need to show that Ptolemy coordinates are identified via the pullback. This follows from Lemma 8.9. \square

Remark 8.11 *A $GL(N, \mathbb{C})/N$ -decoration does not induce a Ptolemy assignment on (M, \mathcal{T}) .*

For $g \in GL(N, \mathbb{C})$, let \bar{g} denote the image of g in $PGL(N, \mathbb{C})$.

Proposition 8.12 *We have a well-defined map*

$$(8-8) \quad \mathcal{Z}: \{PGL(n, \mathbb{C})/B\text{-decorations on } \Delta_n^3\} \rightarrow \{\text{shape assignments on } \Delta_n^3\}$$

$$(\bar{g}_0B, \bar{g}_1B, \bar{g}_2B, \bar{g}_3B) \mapsto \mu \circ \mathcal{C}(g_0N, g_1N, g_2N, g_3N)$$

which is invariant under the left $PGL(n, \mathbb{C})$ -action and compatible with pullbacks.

Proof Let $c = \mathcal{C}(g_0N, g_1N, g_2N, g_3N)$. To prove that \mathcal{Z} is well defined, we must prove that

$$(8-9) \quad \mu(c) = \mu(c'), \quad \text{with } c' = \mathcal{C}(g_0d_0N, \dots, g_3d_3N),$$

where $d_i = d(\lambda_1^i, \dots, \lambda_n^i)$ are diagonal matrices. We prove that $\mu(c)_s^{1100} = \mu(c')_s^{1100}$, the other cases being similar. Using (8-1), we have

$$(8-10) \quad \mu(c')_s^{1100} = \frac{c'_{s+1001} c'_{s+0110}}{c'_{s+1010} c'_{s+0101}}, \quad c'_t = \det\left(\bigcup \{g_i d_i\}_{t_i}\right) = \left(\prod_{j=0}^3 \prod_{i=1}^{t_i} \lambda_i^j\right) c_t.$$

Expanding each term, we obtain

$$\begin{aligned}
 c'_{s+1001} &= \left(\prod_{j=0}^3 \prod_{i=1}^{s_i} \lambda_i^j \right) \lambda_{s_0+1}^0 \lambda_{s_3+1}^3 c_{s+1001}, \\
 c'_{s+0110} &= \left(\prod_{j=0}^3 \prod_{i=1}^{s_i} \lambda_i^j \right) \lambda_{s_1+1}^1 \lambda_{s_2+1}^2 c_{s+0110}, \\
 c'_{s+1010} &= \left(\prod_{j=0}^3 \prod_{i=1}^{s_i} \lambda_i^j \right) \lambda_{s_0+1}^0 \lambda_{s_2+1}^2 c_{s+1010}, \\
 c'_{s+0101} &= \left(\prod_{j=0}^3 \prod_{i=1}^{s_i} \lambda_i^j \right) \lambda_{s_1+1}^1 \lambda_{s_3+1}^3 c_{s+0101}.
 \end{aligned}
 \tag{8-11}$$

It now easily follows that

$$\mu(c'_s)^{1100} = \frac{c'_{s+1001} c'_{s+0110}}{c'_{s+1010} c'_{s+0101}} = \frac{c_{s+1001} c_{s+0110}}{c_{s+1010} c_{s+0101}} = \mu(c)_s^{1100},
 \tag{8-12}$$

as desired. Invariance under left multiplication follows from the fact that

$$\det\left(\bigcup \{g g_i\}_{t_i}\right) = \det(g) \det\left(\bigcup \{g_i\}_{t_i}\right),
 \tag{8-13}$$

and compatibility with pullbacks follows from the fact that both μ and \mathcal{C} enjoy this property. □

Corollary 8.13 *A generic $\mathrm{PGL}(n, \mathbb{C})/B$ -decoration on (M, \mathcal{T}) induces a shape assignment on (M, \mathcal{T}) .*

Proof By Proposition 8.12, we have a shape assignment on each simplex, and we must prove that these satisfy the generalized gluing equations. We proceed as in the proof of Theorem 6.3. Let K be the local model of an edge point, as defined in Section 6.1. We can pull back the decoration on \mathcal{T} to a decoration on K using the simplicial map π . Since K is simply connected, we can change the decoration of each simplex by left multiplication by an element in $\mathrm{PGL}(n, \mathbb{C})$ such that vertices of simplices that get identified in K carry the same coset. This does not affect the shapes. For each vertex in K decorated by gB we pick a lift $\tilde{g}N$ and apply \mathcal{C} to get a Ptolemy assignment on K . By Lemma 6.5 the shapes satisfy the edge equations. The result for the face and interior gluing equations is similar. □

9 The natural cocycle of a generic decoration

In this section, we introduce natural cocycles on M arising from decorations. To define these we need two types of polyhedral decompositions of M , one by *truncated simplices* and one by *doubly truncated simplices*. We show that an $\mathrm{SL}(n, \mathbb{C})/N$ -decoration induces a natural cocycle on the truncated decomposition of M , and that a $\mathrm{PGL}(n, \mathbb{C})/B$ -decoration induces a natural cocycle on the doubly truncated decomposition of M . Later, we give explicit formulas in terms of the Ptolemy coordinates and shape coordinates, respectively.

9.1 Truncated and doubly truncated simplices

As explained in Remark 1.5 we may assume that \mathcal{T} has no interior 0-cells.

Definition 9.1 A *truncated simplex* is a polyhedron obtained from a simplex by truncating its vertices. A *doubly truncated simplex* is a polyhedron obtained from a simplex by first truncating the vertices and then truncating the edges.

We refer to the edges of a truncated simplex as *long* and *short* edges, and the edges of a doubly truncated simplex as *long*, *middle*, and *short* edges.

Note that a triangulation of M induces a decomposition of M into truncated simplices, as well as a decomposition of M into doubly truncated simplices and *prisms*. An *ordering* of a simplex induces an orientation of the edges of the corresponding truncated simplex. Similarly, an *orientation* of a simplex induces orientations of the edges of the corresponding doubly truncated simplex. Note that an ordering is required to obtain natural edge orientations on a truncated simplex.

Remark 9.2 We can view a doubly truncated simplex as the permutohedron of S_4 . We can embed it in a standard simplex Δ_1^3 as the convex hull of $\frac{1}{11}\Delta_{11}^3(\{0, 1, 3, 7\})$, the set $\frac{1}{11}\Delta_{11}^3(\{0, 1, 3, 7\})$ being the vertex set. With this embedding, the long edges are twice as long as the middle edges, which are again twice as long as the short edges (which have length $\sqrt{2}/11$). Similarly, we may view a truncated simplex as the convex hull of $\frac{1}{5}\Delta_5^3(\{0, 1, 4\})$.

9.2 Cocycles

Let G be a group and let X be any space with a polyhedral decomposition.

Definition 9.3 A G -cocycle on X is an assignment of elements in G to the oriented edges of X such that the product around each face is $1 \in G$ and such that reversing the orientation of an edge replaces the labeling by its inverse.

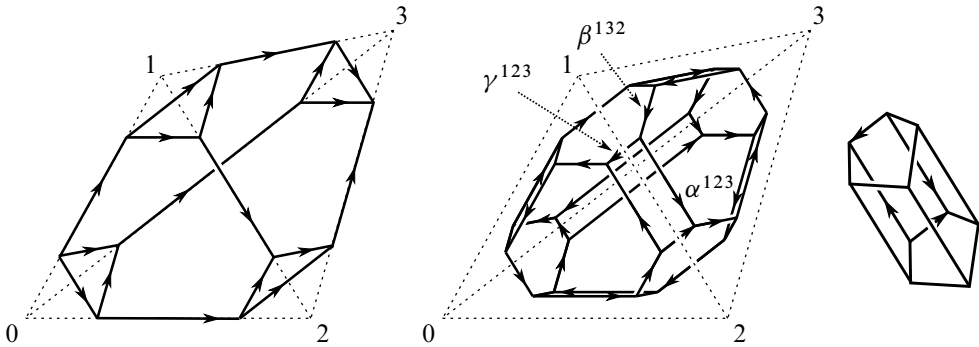

Figure 15: Left: a truncated simplex; edge orientations induced by the vertex ordering. Center: a doubly truncated simplex; edge orientations induced by the orientation. Right: a prism.

Definition 9.4 Let τ be a G -valued 0-cochain on X , ie a function from the vertices to G . The *coboundary* of τ is the G -cocycle

$$(9-1) \quad \delta\tau(\langle v_0, v_1 \rangle) = (\tau^{v_0})^{-1}\tau^{v_1},$$

where $\langle v_0, v_1 \rangle$ is the edge from v_0 to v_1 and τ^{v_i} is the value of τ at v_i . The *coboundary action* of τ on G -cocycles is given by taking σ to the cocycle

$$(9-2) \quad \tau\sigma: \langle v_0, v_1 \rangle \mapsto (\tau^{v_0})^{-1}\sigma(\langle v_0, v_1 \rangle)\tau^{v_1}.$$

Given a simplex Δ , let $\bar{\Delta}$ and $\overline{\overline{\Delta}}$ denote the corresponding truncated, and doubly truncated simplices.

Definition 9.5 Let $H \subset G$ be groups. A (G, H) -cocycle on $\bar{\Delta}$ is a G -cocycle where short edges are labeled by elements in H .

Definition 9.6 Let $K \subset H \subset G$ be groups. A (G, H, K) -cocycle on $\overline{\overline{\Delta}}$ is a G -cocycle where short edges are labeled by elements in K , and middle edges by elements in H .

Remark 9.7 Note that every (G, H) -cocycle on $\bar{\Delta}$ can be obtained from a unique $(G, H, \{e\})$ -cocycle on $\overline{\overline{\Delta}}$ by collapsing the short edges. We shall thus always regard a cocycle on $\bar{\Delta}$ as a cocycle on $\overline{\overline{\Delta}}$.

9.2.1 Labeling conventions We index the vertices of $\overline{\Delta}$ by ordered pairs of distinct vertices of Δ , v_0v_1 being the vertex near v_0 on the edge to v_1 . We index the vertices of $\overline{\Delta}$ by ordered triples of distinct vertices of Δ , $v_0v_1v_2$ being the vertex whose closest vertex in Δ is v_0 , closest edge v_0v_1 , and closest face $v_0v_1v_2$. Given a cocycle on $\overline{\Delta}$, we use α s to denote the labeling of long edges, β s for the middle edges, and γ s for the short edges. Note that an edge of each type is uniquely determined by its initial vertex. This gives a unique labeling scheme, eg the long edge from $v_0v_1v_2$ to $v_1v_0v_2$ is labeled by $\beta^{v_0v_1v_2}$. Similarly, if τ is a 0-cochain, the value at $v_0v_1v_2$ is denoted by $\tau^{v_0v_1v_2}$. We shall not need a labeling scheme for cocycles on truncated simplices. By Remark 9.7 we can regard these as cocycles on the corresponding doubly truncated simplices.

9.3 The natural cocycle of a generic decoration

We now show that sufficiently generic decorations naturally give rise to cocycles on M .

Definition 9.8 A pair (g_0N, g_1N) of N -cosets in $\mathrm{SL}(n, \mathbb{C})$ is *sufficiently generic* if there exists a (necessarily unique) $g \in \mathrm{SL}(n, \mathbb{C})$ such that

$$(9-3) \quad (g_0N, g_1N) = g(N, qN) \quad \text{with } q \text{ counter-diagonal.}$$

A tuple is sufficiently generic if it is pairwise sufficiently generic.

Let N^- denote the lower-triangular matrices in $\mathrm{SL}(n, \mathbb{C})$ with 1 on the diagonal.

Definition 9.9 An element $n \in B$ is *normalized* if the *last* column vector consists of 1s. An element $n_- \in N^-$ is *normalized* if the *first* column vector consists of 1s.

Definition 9.10 A triple (g_0B, g_1B, g_2B) of B -cosets in $\mathrm{PGL}(n, \mathbb{C})$ is *sufficiently generic* if there exists a (necessarily unique) $g \in \mathrm{PGL}(n, \mathbb{C})$ such that

$$(9-4) \quad (g_0B, g_1B, g_2B) = g(B, q_1B, n_-B) \quad \text{with } n_- \in N^- \text{ normalized.}$$

A tuple is sufficiently generic if each triple is sufficiently generic.

Remark 9.11 A simple exercise in linear algebra shows that a generic decoration (as in Definition 8.5) is sufficiently generic.

Definition 9.12 Let (g_0N, g_1N, g_2N, g_3N) be a generic $\mathrm{SL}(n, \mathbb{C})/N$ -decoration on Δ_n^3 . The *natural* $(\mathrm{SL}(n, \mathbb{C}), N)$ -cocycle on $\overline{\Delta_n^3}$ is the coboundary of the unique 0-cochain τ satisfying

$$(9-5) \quad (g_{v_0}N, g_{v_1}N) = \tau^{v_0v_1}(N, qN) \quad \text{with } q \text{ counter-diagonal.}$$

This defines the map $\mathcal{L}_{\alpha\beta}$ in (1-5). It follows immediately from the definition that the natural cocycle labels short edges by elements in N and long edges by counter-diagonal elements. Let q_1 denote the counter-diagonal matrix whose nonzero entries are all 1. Note that $q_1 = q_1^{-1}$.

Definition 9.13 Let (g_0B, g_1B, g_2B, g_3B) be a generic decoration on a simplex. The natural $(\mathrm{PGL}(n, \mathbb{C}), B, H)$ -cocycle on $\overline{\Delta}_n^3$ is the coboundary of the unique 0-cochain τ satisfying

$$(9-6) \quad (g_{v_0}B, g_{v_1}B, g_{v_2}B) = \tau^{v_0v_1v_2}(B, q_1B, n_-B), \quad \text{with } n_- \in N^- \text{ normalized.}$$

This defines the map $\mathcal{L}_{\alpha\beta\gamma}$ in (1-5).

Remark 9.14 Note that a (G, H) -cocycle σ on $\overline{\Delta}$ determines a G/H -decoration D on Δ . We say that D is compatible with σ . To see this, note that σ is the coboundary of a 0-cochain τ on $\overline{\Delta}$, which is unique up to left multiplication by an element in G . The value of τ at the vertices near a vertex of Δ are all in the same H -coset. Hence, we have a decoration on Δ . Similarly, a (G, B, H) -cocycle on $\overline{\Delta}$ determines a G/B -decoration on Δ . It follows that the maps $\mathcal{L}_{\alpha\beta}$ and $\mathcal{L}_{\alpha\beta\gamma}$ are bijective with explicit inverses.

Lemma 9.15 Let $D = (g_0B, g_1B, g_2B, g_3B)$ be a generic decoration on a simplex. The natural $(\mathrm{PGL}(n, \mathbb{C}), B, H)$ -cocycle is the unique cocycle which is compatible with the decoration and satisfies the following properties:

- (i) Short edges are labeled by elements in H .
- (ii) Middle edges are labeled by normalized elements in B .
- (iii) Long edges are labeled by q_1 .

Proof We first show that the natural cocycle satisfies the three conditions. It is enough to prove this for a single edge of each type. We may assume that $D = (B, q_1, B, n_-B, m_-B)$, where $n_-, m_- \in N^-$ and n_- is normalized. Then $\tau^{012} = 1$, so, for each edge starting at 012, we only need to compute the value of τ at the endpoint. Since $(q_1B, B, n_-B) = q_1(B, q_1B, q_1n_-B)$, and the first column vector of q_1n_- consists of 1s, it follows that $\tau^{102} = q_1$, proving the result for the long edges. Since the stabilizer of B is B , it follows that $\tau^{021} \in B$, proving the result for the middle edges. Finally, τ^{013} is the unique element in H such that hm_-h^{-1} is normalized, proving the result for the short edges.

Let σ_1 and σ_2 be two cocycles satisfying the required conditions. Since any two cocycles differ by the coboundary action, $\sigma_2 = \eta\sigma_1$ for some coboundary η . Since

long edges are labeled by q_1 and since the cocycles determine the same decoration, we may assume that η takes values in H . It is now elementary to check that if η is not the identity, either (ii) or (iii) fails. \square

Remark 9.16 Note that for a generic decoration on a triangulation of M , the natural cocycles on each simplex fit together to form a natural cocycle on M .

10 Explicit formulas for the natural cocycles

We now show that the cocycle associated to a $\text{PGL}(n, \mathbb{C})/B$ -decoration D is determined by the shape assignment $\mathcal{Z}(D)$. The reader should keep in mind the diagram (1-5).

Define

$$(10-1) \quad q(a_1, \dots, a_n) = \begin{pmatrix} & & a_n \\ & \ddots & \\ & & \\ a_1 & & \end{pmatrix}, \quad d(a_1, \dots, a_n) = \begin{pmatrix} a_1 & & \\ & \ddots & \\ & & \\ & & a_1 \end{pmatrix},$$

$$q_1 = q(1, \dots, 1), \quad d_{\pm 1} = d(\{(-1)^{n-k}\}_{k=1}^n),$$

$$H_i(x) = d(\overbrace{(x, \dots, x)}^i, 1, \dots, 1).$$

Letting $E_{i,i+1}$ be the matrix with a 1 as the $(i, i + 1)$ entry and zeros elsewhere, we define

$$(10-2) \quad x_i(t) = I + tE_{i,i+1}.$$

10.1 Diamond and ratio coordinates

It is shown in [16] that the short edges of the natural cocycle of a generic $\text{SL}(n, \mathbb{C})/N$ -decoration are given by *diamond coordinates*, and that the long edges are given by ratios of two Ptolemy coordinates. We review these results below.

Definition 10.1 Let c be a Ptolemy assignment on Δ_n^3 . For each vertex $v_0 v_1 v_2$ of $\overline{\Delta_n^3}$ and each $\alpha \in \Delta_{n-2}^3(\mathbb{Z})$ on the face containing $v_0 v_1 v_2$, we associate a *diamond coordinate*

$$(10-3) \quad d_\alpha^{v_0 v_1 v_2}(c) = -\varepsilon_{<}^{v_0 v_1 v_2} \frac{c_\alpha + 2v_0 c_\alpha + v_1 + v_2}{c_\alpha + v_0 + v_1 c_\alpha + v_0 + v_2}.$$

Here $\varepsilon_{<}^{v_0 v_1 v_2}$ is the sign of the S_3 permutation required to bring the sequence v_0, v_1, v_2 into lexicographic order.

Definition 10.2 Let c be a Ptolemy assignment on Δ_n^3 . For each vertex $v_0 v_1 v_2$ of Δ_n^3 and each point $kv_0 + lv_1$ on the long edge containing $v_0 v_1 v_2$, we associate a ratio coordinate

$$(10-4) \quad e_{kv_0+lv_1}^{v_0 v_1}(c) = \varepsilon^{n-1} (-1)^l \frac{c_{kv_0+(l+1)v_1}}{c_{(k+1)v_0+lv_1}},$$

where $k + l = n - 1$, and $\varepsilon = 1$ if $v_0 < v_1$ and $\varepsilon = -1$ otherwise.

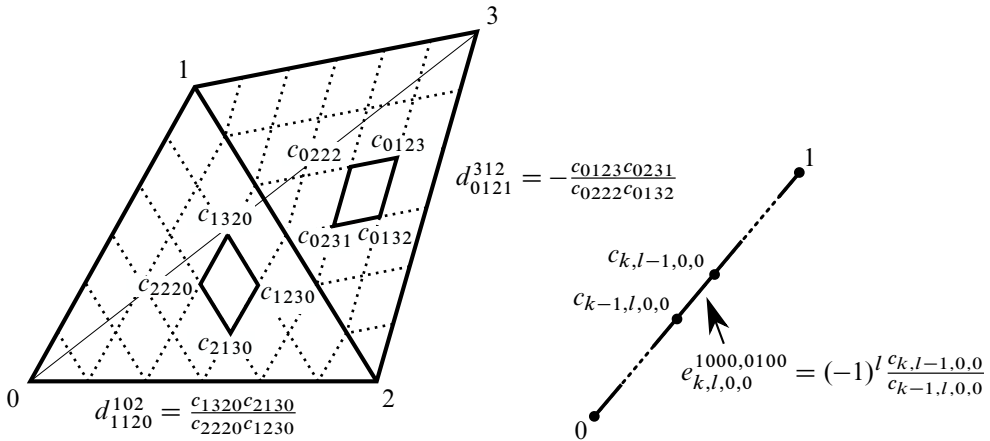

Figure 16: Left: diamond coordinates. Right: ratio coordinates.

Notation 10.3 When c is clear from the context, we suppress it from the notation, ie we write $d_\alpha^{v_0 v_1 v_2}$ and $e_{kv_0+lv_1}^{v_0 v_1}$ instead of $d_\alpha^{v_0 v_1 v_2}(c)$ and $e_{kv_0+lv_1}^{v_0 v_1}(c)$.

As explained in Remark 9.7, we can view the natural cocycle of an $\text{SL}(n, \mathbb{C})/N$ -decoration as a cocycle on Δ_n^3 . We thus employ the labeling conventions of Section 9.2.1.

Proposition 10.4 [16] The natural cocycle $\mathcal{L}_{\alpha\beta}(D)$ of a generic $\text{SL}(n, \mathbb{C})/N$ -decoration D on Δ_n^3 is given in terms of the Ptolemy assignment $\mathcal{C}(D)$ by

$$(10-5) \quad \gamma^{v_0 v_1 v_2} = \text{id}, \quad \beta^{v_0 v_1 v_2} = \prod_{(\alpha_0, \alpha_1, \alpha_2) \in \Delta_{n-2}^2(\mathbb{Z})} x_{\alpha_1+1} (d_{\alpha_1 v_0 + \alpha_2 v_1 + \alpha_0 v_2}^{v_0 v_1 v_2}),$$

$$\alpha^{v_0 v_1 v_2} = q(e_{(n-1)v_0}^{v_0 v_1}, e_{(n-2)v_0+v_1}^{v_0 v_1}, \dots, e_{(n-1)v_1}^{v_0 v_1}).$$

The factors in the product are ordered by the lexicographic order on $\Delta_{n-2}^2(\mathbb{Z})$. □

Remark 10.5 It is convenient to introduce the notation

$$(10-6) \quad d_{k,i} = d_{(i-1)v_0+(n-i-k)v_1+(k-1)v_2}^{v_0 v_1 v_2}$$

With this notation, the formula for the middle edge becomes

$$(10-7) \quad \beta^{v_0 v_1 v_2} = \prod_{k=1}^{n-1} \prod_{i=1}^{n-k} x_i(d_{k,i}).$$

This agrees with the notation in [16]. Although this notation is convenient, it does not behave properly under reordering.

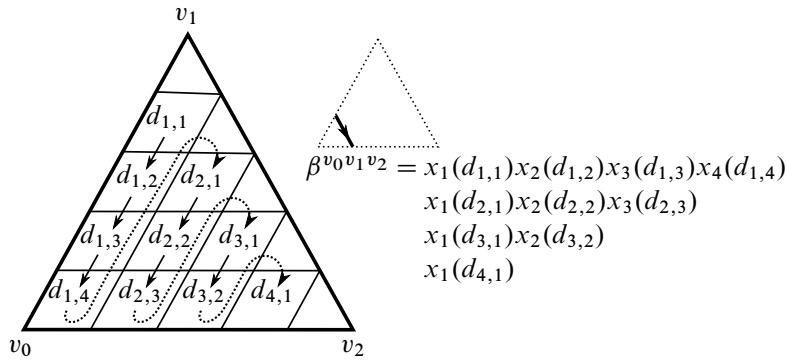

Figure 17: Factorization of a middle edge $\beta^{v_0 v_1 v_2}$ in terms of diamond coordinates

10.1.1 Behavior under reordering

Lemma 10.6 *The diamond coordinates of c and $\sigma^*(c)$ are related by*

$$(10-8) \quad d(\sigma^*(c))_{\alpha}^{v_0 v_1 v_2} = d(c)_{\sigma(\alpha)}^{\sigma(v_0)\sigma(v_1)\sigma(v_2)}.$$

Proof It is enough to prove this for $v_i = i$ and $\sigma = \sigma_{01}$, $\sigma = \sigma_{12}$ and $\sigma = \sigma_{23}$. We prove it for $\sigma = \sigma_{01}$, the other cases being similar. Letting $t = \alpha + e_0 + e_1$ and $\alpha' = \sigma_{01}(\alpha)$, and using that $\varepsilon_{<}^{012} = 1$ and $\varepsilon_{<}^{102} = -1$, we have

$$(10-9) \quad \begin{aligned} & d(\sigma_{01}^*(c))_{\alpha}^{012} \\ &= -\frac{\sigma_{01}^*(c)_{\alpha+2e_0} \sigma_{01}^*(c)_{\alpha+e_1+e_2}}{\sigma_{01}^*(c)_{\alpha+e_0+e_1} \sigma_{01}^*(c)_{\alpha+e_0+e_2}} \\ &= -\frac{\det I_{\sigma_{01}, \sigma_{01}(t+e_0-e_1)} \det I_{\sigma_{01}, \sigma_{01}(t+e_2-e_0)}}{\det I_{\sigma_{01}, \sigma_{01}(t)} \det I_{\sigma_{01}, \sigma_{01}(t+e_2-e_1)}} \frac{c_{\alpha'+2e_1} c_{\alpha'+e_0+e_2}}{c_{\alpha'+e_1+e_0} c_{\alpha'+e_1+e_2}} \\ &= -\frac{(-1)^{(t_0+1)(t_1-1)} (-1)^{(t_0-1)t_1}}{(-1)^{t_0 t_1} (-1)^{t_0(t_1-1)}} \frac{c_{\alpha'+2e_1} c_{\alpha'+e_0+e_2}}{c_{\alpha'+e_1+e_0} c_{\alpha'+e_1+e_2}} \\ &= -(-1) \frac{c_{\alpha'+2e_1} c_{\alpha'+e_0+e_2}}{c_{\alpha'+e_1+e_0} c_{\alpha'+e_1+e_2}} = d(c)_{\alpha'}^{102}. \end{aligned}$$

This proves the result. □

Lemma 10.7 *The ratio coordinates of c and σ^*c are related by*

$$(10-10) \quad \sigma^*(e)_\alpha^{v_0v_1} = e_{\sigma(\alpha)}^{\sigma(v_0)\sigma(v_1)}.$$

Proof We shall not need this, so we leave the proof to the reader. □

10.2 X -coordinates

We define X -coordinates for Ptolemy assignments and shape assignments. These are defined for face points, and they agree with the X -coordinates of Fock and Goncharov [12, page 133].

The natural A_4 action on vertices of $\overline{\Delta}$ has two orbits. Let $\varepsilon_{\mathcal{O}}^{v_0v_1v_2}$ be a sign which is positive if and only if $v_0v_1v_2$ is in the orbit of 012.

Definition 10.8 Let c be a Ptolemy assignment and let $t \in \Delta_n^3(\mathbb{Z})$ be a face point. The X -coordinate at t is given by

$$(10-11) \quad X_t = \prod_{t \in \text{face}(v_0v_1v_2)} c_{t+v_0-v_1}^{\varepsilon_{\mathcal{O}}^{v_0v_1v_2}},$$

where the product is taken over the six ordered triples of vertices v_0, v_1, v_2 spanning the face containing t .

As an example, the X -coordinate of $t = (t_0, t_1, t_2, 0)$ is given by

$$(10-12) \quad X_{(t_0, t_1, t_2, 0)} = \frac{c_{t+e_0-e_1} c_{t+e_1-e_2} c_{t+e_2-e_0}}{c_{t+e_0-e_2} c_{t+e_1-e_0} c_{t+e_2-e_1}}.$$

Definition 10.9 Let z be a shape assignment on Δ_n^3 and let t be a face point spanned by v_0, v_1 and v_2 . The X -coordinate at t is given by

$$(10-13) \quad X_t = - \prod_{s+e=t} z_s^e.$$

Remark 10.10 Note that the product (10-13) consists of half of the terms involved in a face equation. More precisely, if $v_0v_1v_2 \in \overline{\Delta}_0$ is glued to $w_0w_1w_2 \in \overline{\Delta}_1$, the face equations are given by

$$(10-14) \quad X_{t_0v_0+t_1v_1+t_2v_2}^{\varepsilon_{\mathcal{O}}^{v_0v_1v_2}} = X_{t_0w_0+t_1w_1+t_2w_2}^{\varepsilon_{\mathcal{O}}^{w_0w_1w_2}}.$$

Note that $\varepsilon_{\mathcal{O}}^{v_0v_1v_2}$ and $\varepsilon_{\mathcal{O}}^{w_0w_1w_2}$ are equal if and only if the face pairing preserves orientation. For oriented triangulations the signs are always opposite.

Lemma 10.11 *The X -coordinates transform as the shapes under reordering, ie we have*

$$(10-15) \quad X(\sigma^*(c))_t = X(c)_{\sigma(t)}^{\text{sgn } \sigma}, \quad X(\sigma^*(z))_t = X(z)_{\sigma(t)}^{\text{sgn } \sigma}.$$

Proof Unwinding the definitions, we have

$$(10-16) \quad \begin{aligned} X(\sigma^*c)_t &= \prod_{t \in \text{face}(v_0 v_1 v_2)} (\sigma^*c)_{t+v_0-v_1}^{\varepsilon_{\cup}^{v_0 v_1 v_2}} \\ &= \prod_{t \in \text{face}(v_0 v_1 v_2)} \det(I_{\sigma, \sigma(t+v_0-v_1)}) c_{\sigma(t)+\sigma(v_0)-\sigma(v_1)}^{\varepsilon_{\cup}^{v_0 v_1 v_2}} \\ &= \left(\prod_{t \in \text{face}(v_0 v_1 v_2)} \det I_{\sigma, \sigma(t+v_0-v_1)} \right) X(c)_{\sigma(t)}^{\text{sgn } \sigma} \\ &= X(c)_{\sigma(t)}^{\text{sgn } \sigma}. \end{aligned}$$

The fact that the product of determinants equals 1 follows from Remark 5.7, which implies that $\det I_{\sigma, \sigma(t+v_0-v_1)} = \det I_{\sigma, \sigma(t+v_1-v_0)}$. Since both are ± 1 , their product is 1. The second equation is obvious. □

Lemma 10.12 *The X -coordinates of a Ptolemy assignment c agree with the X -coordinates of the corresponding shape assignment $\mu(c)$.*

Proof We must prove that

$$(10-17) \quad - \prod_{s+e=t} \mu(c)_s^e = \prod_{t \in \text{face}(v_0 v_1 v_2)} c_{t+v_0-v_1}^{\varepsilon_{\cup}^{v_0 v_1 v_2}}.$$

By compatibility under reordering, it is enough to prove this for $t = (t_0, t_1, t_2, 0) = t_0 e_0 + t_1 e_1 + t_2 e_2$. Let $t = \alpha + (1110)$. By (6-8),

$$(10-18) \quad \begin{aligned} - \prod_{s+e=t} \mu(c)_s^e &= z_{\alpha+0010}^{1100} z_{\alpha+1000}^{0110} z_{\alpha+0010}^{-1010} \\ &= \frac{c_{\alpha+2010,0} c_{\alpha+1200,0} c_{\alpha+0120,0}}{c_{\alpha+2100,0} c_{\alpha+0210,0} c_{\alpha+1020,0}} \\ &= \frac{c_{t+e_0-e_1} c_{t+e_1-e_2} c_{t+e_2-e_0}}{c_{t+e_0-e_2} c_{t+e_1-e_0} c_{t+e_2-e_1}} \\ &= \prod_{t \in \text{face}(v_0 v_1 v_2)} c_{t+v_0-v_1}^{\varepsilon_{\cup}^{v_0 v_1 v_2}}, \end{aligned}$$

where the last equality follows from (10-12). □

Lemma 10.13 One can express the X -coordinates in terms of diamond coordinates:

$$(10-19) \quad X_t = \left(\frac{d_{t-v_0-v_1}^{v_0 v_1 v_2}}{d_{t-v_0-v_2}^{v_0 v_1 v_2}} \right)^{\varepsilon_{\cup}^{v_0 v_1 v_2}}$$

Here t is a face point spanned by v_0, v_1 and v_2 .

Proof It is enough to prove this for $t = (t_0, t_1, t_2, 0)$. Since

$$(10-20) \quad d_{t-e_0-e_1}^{012} = -\frac{c_{t+e_0-e_1} c_{t+e_2-e_0}}{c_t c_{t+e_2-e_1}} \quad \text{and} \quad d_{t-e_0-e_2}^{012} = -\frac{c_{t+e_0-e_2} c_{t+e_1-e_0}}{c_{t+e_1-e_2} c_t},$$

the result follows from (10-12). □

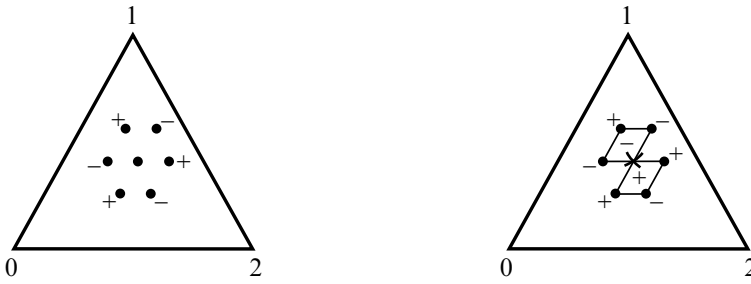

Figure 18: Left: exponents of the Ptolemy coordinates involved in the X -coordinate at t . Right: an X -coordinate as a quotient of two diamond coordinates.

10.3 From natural $(\text{SL}(n, \mathbb{C}), N)$ -cocycles to natural $(\text{PGL}(n, \mathbb{C}), B, H)$ -cocycles

The natural map $\pi: \text{SL}(n, \mathbb{C}) \rightarrow \text{PGL}(n, \mathbb{C})$ induces a map from decorations by N -cosets to decorations by B -cosets. Given a generic $\text{SL}(n, \mathbb{C})/N$ -decoration D on Δ_n^3 , we show how the natural $(\text{PGL}(n, \mathbb{C}), B, H)$ -cocycle $\mathcal{L}_{\alpha\beta\gamma}(\pi(D))$ can be obtained from the natural cocycle $\mathcal{L}_{\alpha\beta}(D)$ by the coboundary action (9-2) of an explicit coboundary given in terms of the diamond coordinates. This defines the map τ in diagram (1-5) and gives rise to an explicit formula for $\mathcal{L}_{\alpha\beta\gamma}(\pi(D))$ in terms of the shapes.

Given an $\text{SL}(n, \mathbb{C})/N$ -decoration D with diamond coordinates $d_{1,i}^{v_0, v_1, v_2}$, consider the 0-cochain $\tau(D)$ on $\overline{\Delta_n^3}$ given by

$$(10-21) \quad \begin{aligned} \tau^{v_0 v_1 v_2}(D) &= d \left(\prod_{i=1}^{n-1} d_{1,i}^{v_0 v_1 v_2}, \prod_{i=2}^{n-1} d_{1,i}^{v_0 v_1 v_2}, \dots, d_{1,n-i}^{v_0 v_1 v_2}, 1 \right) \\ &= \prod_{i=1}^{n-1} H_i(d_{1,i}^{v_0 v_1 v_2}). \end{aligned}$$

We shall make use of the abbreviations

$$(10-22) \quad X_{k,i} = X_{kv_2 + iv_0 + (n-k-i)v_1}, \quad z_i = z_{(i-1)v_0 + (n-1-i)v_1}.$$

Theorem 10.14 *Let D be a generic $\text{PGL}(n, \mathbb{C})/B$ -decoration of Δ_n^3 . The natural cocycle $\mathcal{L}_{\alpha\beta\gamma}(D)$ is given by*

$$(10-23) \quad \begin{aligned} \alpha^{v_0v_1v_2} &= q_1, \quad \beta^{v_0v_1v_2} = \prod_{k=1}^{n-1} \left(\prod_{i=1}^{n-k} x_i(1) \prod_{i=1}^{n-k-1} H_i(X_{k,i}^{\varepsilon_{\cup}^{v_0v_1v_2}}) \right) d_{\pm 1}, \\ \gamma^{v_0v_1v_2} &= \prod_{i=1}^{n-1} H_i(z_i^{-\varepsilon_{\cup}^{v_0v_1v_2}}). \end{aligned}$$

Moreover, if \tilde{D} is any $\text{SL}(n, \mathbb{C})/N$ -decoration lifting D , $\mathcal{L}_{\alpha\beta\gamma}(D) = \tau \mathcal{L}_{\alpha\beta}(\tilde{D})$. \square

Before embarking on the proof, we give some examples.

Example 10.15 For $n = 2$,

$$(10-24) \quad \beta^{012} = x_1(1)d_{\pm 1} = \begin{pmatrix} -1 & 1 \\ & 1 \end{pmatrix}, \quad \gamma^{012} = H_1(z_1^{-1}) = \begin{pmatrix} z_1^{-1} & \\ & 1 \end{pmatrix}.$$

For $n = 3$, we have

$$(10-25) \quad \begin{aligned} \beta^{012} &= x_1(1)x_2(1)H_1(X_{1,1})x_1(1)d_{\pm 1} = \begin{pmatrix} X_{1,1} & -X_{1,1} & 1 \\ & -1 & 1 \\ & & 1 \end{pmatrix}, \\ \gamma^{012} &= H_1(z_1^{-1})H_2(z_2^{-1}) = \begin{pmatrix} z_1^{-1}z_2^{-1} & & \\ & z_2^{-1} & \\ & & 1 \end{pmatrix}. \end{aligned}$$

For $n = 4$,

$$(10-26) \quad \begin{aligned} \beta^{012} &= x_1(1)x_2(1)x_3(1)H_1(X_{1,1})H_2(X_{1,2}) \\ &\quad \times x_1(1)x_2(1)H_1(X_{2,1})x_1(1)d_{\pm 1}, \\ \gamma^{012} &= d(z_1^{-1}z_2^{-1}z_3^{-1}, z_2^{-1}z_3^{-1}, z_3^{-1}, 1). \end{aligned}$$

Remark 10.16 The formula for $\beta^{v_0v_1v_2}$ is inspired by [12, (9.14)].

Remark 10.17 Note that the diagonal entries of $\beta^{v_0v_1v_2}$ and $\gamma^{v_0v_1v_2}$ are given by

$$(10-27) \quad \beta_{ll}^{v_0v_1v_2} = (-1)^{n-l} \prod_{i=l}^{n-2} \prod_{k=1}^{n-1-i} X_{k,i}^{\varepsilon_{\cup}^{v_0v_1v_2}}, \quad \gamma_{ll}^{v_0v_1v_2} = \prod_{i=l}^{n-1} z_i^{-\varepsilon_{\cup}^{v_0v_1v_2}}.$$

Proof of Theorem 10.14 We prove that $\tau(\tilde{D})\mathcal{L}_{\alpha\beta}(\tilde{D})$ is given by (10-23). Since the last column of $\prod_{i=1}^{n-1} x_i(1)$ consists of 1s and since none of the other terms affect the last column, the middle edges are thus normalized, so by Lemma 9.15, the cocycle is indeed the natural cocycle of D .

Let $\tilde{\alpha}$, $\tilde{\beta}$ (and $\tilde{\gamma} = \mathrm{id}$) be the labelings of long, middle and short edges given by $L_{\alpha\beta}(\tilde{D})$. By Proposition 10.4 these are given by (10-5). Let $\tau = \tau(\tilde{D})$.

Long edges We must prove that $(\tau^{v_0 v_1 v_2})^{-1} \tilde{\alpha}^{v_0 v_1 v_2} \tau^{v_1 v_0 v_2} = q_1$. Letting

$$(10-28) \quad l_k = \prod_{i=k}^{n-1} d_{1,i}^{v_0 v_1 v_2}, \quad m_k = (-1)^{k-1} e^{v_0 v_1}_{(n-k)v_0 + (k-1)v_1}, \quad r_k = \prod_{i=k}^{n-1} d_{1,i}^{v_1 v_0 v_2},$$

this is equivalent to proving that

$$(10-29) \quad d(l_1, \dots, l_n)^{-1} q(m_1, \dots, m_n) d(r_1, \dots, r_n) = q_1 \in \mathrm{PGL}(n, \mathbb{C}).$$

Hence, we must prove that $l_{n-k+1}^{-1} m_k r_k$ is independent of k . From Figure 19 it follows that

$$(10-30) \quad \prod_{i=k}^{n-1} d_{1,i}^{v_0 v_1 v_2} = \varepsilon^{n-k} \frac{C_{n v_0} C_{(k-1)v_0 + (n-k)v_1 + v_2}}{C_{(n-1)v_0 + v_2} C_{k v_0 + (n-k)v_1}},$$

$$\prod_{i=k}^{n-1} d_{1,i}^{v_1 v_0 v_2} = (-\varepsilon)^{n-k} \frac{C_{n v_1} C_{(k-1)v_1 + (n-k)v_0 + v_2}}{C_{(n-1)v_1 + v_2} C_{k v_1 + (n-k)v_0}},$$

where $\varepsilon = -\varepsilon_{<}^{v_0 v_1 v_2}$. Hence, we have

$$(10-31) \quad l_{n-k+1} = \varepsilon^{k-1} \frac{C_{(n-k)v_0 + (k-1)v_1 + v_2}}{C_{(n-k+1)v_0 + (k-1)v_1} C_{(n-1)v_0 + v_2}},$$

$$m_k = (-1)^{k-1} \frac{C_{(n-k)v_0 + k v_1}}{C_{(n-k+1)v_0 + (k-1)v_1}},$$

$$r_k = (-\varepsilon)^{n-k} \frac{C_{(k-1)v_1 + (n-k)v_0 + v_2}}{C_{(n-1)v_1 + v_2} C_{k v_1 + (n-k)v_0}},$$

from which it follows that

$$(10-32) \quad l_{n-k+1}^{-1} m_k r_k = (-\varepsilon)^{n-1} \frac{C_{(n-1)v_0 + v_2}}{C_{(n-1)v_1 + v_2}},$$

which is independent of k . This proves the result.

Middle edges We must prove that $\tau_{v_0 v_1 v_2}^{-1} \tilde{\beta}^{v_0 v_1 v_2} \tau_{v_0 v_2 v_1} = \beta_{v_0 v_1 v_2}$. Using the basic commutator relations

$$(10-33) \quad H_i(x)x_j(y) = x_j(y)H_i(x) \quad \text{if } i \neq j, \quad x_i(y) = H_i(y)x_i(1)H_i(y)^{-1},$$

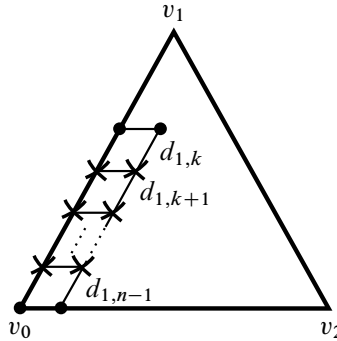

Figure 19: Cancellations

the expression

$$(10-34) \quad \tilde{\beta}^{v_0 v_1 v_2} = \prod_{k=1}^{n-1} \prod_{i=1}^{n-k} x_i(d_{k,i}) = \prod_{k=1}^{n-1} \prod_{i=1}^{n-k} H_i(d_{k,i}) x_i(1) H_i(d_{k,i})^{-1}$$

expands to

$$(10-35) \quad \tilde{\beta}^{v_0 v_1 v_2} = \prod_{k=1}^{n-1} \left(\prod_{i=1}^{n-k} H_i(d_{k,i}) \prod_{i=1}^{n-k} x_i(1) \right. \\ \left. \times \left(\prod_{i=1}^{n-k-1} H_i(d_{k,i})^{-1} \right) H_{n-k}(d_{k,n-k})^{-1} \right).$$

We have for brevity omitted the superscript $v_0 v_1 v_2$ of the diamond coordinates. Letting

$$(10-36) \quad \mathcal{H}_k = \prod_{i=1}^{n-k} H_i(d_{k,i}) \quad \text{and} \quad \mathcal{H}'_k = \prod_{i=1}^{n-k-1} H_i(d_{k,i}),$$

and moving the terms $H_{n-k}(d_{k,n-k})^{-1}$ to the right, we have

$$(10-37) \quad \tilde{\beta}^{v_0 v_1 v_2} = \prod_{k=1}^{n-1} \left(\mathcal{H}_k \left(\prod_{i=1}^{n-k} x_i(1) \right) \mathcal{H}'_k{}^{-1} \right) \prod_{k=1}^{n-1} H_{n-k}(d_{k,n-k})^{-1}.$$

Since $\mathcal{H}_n = 1$, the products

$$(10-38) \quad (\mathcal{H}_1 \cdots \mathcal{H}'_1{}^{-1})(\mathcal{H}_2 \cdots \mathcal{H}'_2{}^{-1}) \cdots \quad \text{and} \quad \mathcal{H}_1(\cdots \mathcal{H}'_1{}^{-1} \mathcal{H}_2)(\cdots \mathcal{H}'_2{}^{-1} \mathcal{H}_3) \cdots$$

are equal, and we obtain

$$(10-39) \quad \tilde{\beta}_{v_0 v_1 v_2} = \mathcal{H}_1 \prod_{k=1}^{n-1} \left(\left(\prod_{i=1}^{n-k} x_i(1) \right) \mathcal{H}'_k{}^{-1} \mathcal{H}_{k+1} \right) \prod_{k=1}^{n-1} H_{n-k}(d_{k,n-k})^{-1}.$$

Using (10-3), we have

$$(10-40) \quad d_{1,i}^{v_0 v_2 v_1} = d_{(i-1)v_0 + (n-1-i)v_2}^{v_0 v_2 v_1} = -d_{(i-1)v_0 + (n-1-i)v_2}^{v_0 v_1 v_2} = -d_{n-i,i}^{v_0 v_1 v_2},$$

and since (last equality follows from (10-40))

$$(10-41) \quad \begin{aligned} \tau^{v_0 v_1 v_2} &= \prod_{i=1}^{n-1} H_i(d_{1,i}^{v_0 v_1 v_2}) = \mathcal{H}_1, \\ \tau^{v_0 v_2 v_1} &= \prod_{i=1}^{n-1} H_i(d_{1,i}^{v_0 v_2 v_1}) = \prod_{k=1}^{n-1} H_{n-k}(-d_{k,n-k}), \end{aligned}$$

we have

$$(10-42) \quad \beta_{v_0 v_1 v_2} = \tau_{v_0 v_1 v_2}^{-1} \tilde{\beta}_{v_0 v_1 v_2} \tau_{v_0 v_2 v_1} = \prod_{k=1}^{n-1} \left(\left(\prod_{i=1}^{n-k} x_i(1) \right) \mathcal{H}'_k{}^{-1} \mathcal{H}_{k+1} \right) d_{\pm 1}.$$

By Lemma 10.13, $d_{k+1,i}/d_{k,i} = X_{k,i}^{\varepsilon_{\cup}(v_0 v_1 v_2)}$, so that

$$(10-43) \quad \mathcal{H}'_k{}^{-1} \mathcal{H}_{k+1} = \prod_{i=1}^{n-k} H_i(d_{k,i})^{-1} H_i(d_{k+1,i}) = \prod_{i=1}^{n-k} H_i(X_{k,i}^{\varepsilon_{\cup}(v_0 v_1 v_2)}).$$

This proves the result.

Short edges We must prove that $(\tau^{v_0 v_1 v_2})^{-1} \tau^{v_0 v_1 v_3} = \gamma^{v_0 v_1 v_2}$. We have

$$(10-44) \quad \begin{aligned} (\tau^{v_0 v_1 v_2})^{-1} \tau^{v_0 v_1 v_3} &= \left(\prod_{i=1}^{n-1} H_i(d_{1,i}^{v_0 v_1 v_2}) \right)^{-1} \prod_{i=1}^{n-1} H_i(d_{1,i}^{v_0 v_1 v_3}) \\ &= \prod_{i=1}^{n-1} H_i \left(\frac{d_{1,i}^{v_0 v_1 v_3}}{d_{1,i}^{v_0 v_1 v_2}} \right). \end{aligned}$$

The result now follows from Lemma 10.18 below.

Lemma 10.18 *The shape parameters in (10-23) are given in terms of diamond coordinates by*

$$(10-45) \quad z_i^{-\varepsilon_{\cup}^{v_0 v_1 v_2}} = \frac{d_{1,i}^{v_0 v_1 v_3}}{d_{1,i}^{v_0 v_1 v_2}}.$$

Proof Let $\alpha = (i-1)v_0 + (n-1-i)v_1$, so that $z_i = z_{\alpha}^{v_0+v_1}$ and $d_{1,i}^{v_0 v_1 v_k} = d_{\alpha}^{v_0 v_1 v_k}$, $k = 2, 3$. By compatibility under reordering, it is enough to prove the result for $v_i = i$. We have

$$(10-46) \quad z_{\alpha}^{1100} = \frac{c_{\alpha+e_0+e_3} c_{\alpha+e_1+e_2}}{c_{\alpha+e_0+e_2} c_{\alpha+e_1+e_3}}, \quad d_{\alpha}^{01k} = -\frac{c_{\alpha+2e_0} c_{\alpha+e_1+e_k}}{c_{\alpha+e_0+e_1} c_{\alpha+e_0+e_k}}.$$

Hence $z_i^{-1} = d_{1,i}^{013} / d_{1,i}^{012}$, proving the result. □

This concludes the proof of Theorem 10.14. □

Remark 10.19 Theorem 10.14 implies that, for a generic $\text{PGL}(n, \mathbb{C})/B$ -decoration on (M, \mathcal{T}) , the restriction of the natural cocycle to ∂M has a canonical lift to a cocycle with values in $B \subset \text{GL}(n, \mathbb{C})$ (not just in $\text{PGL}(n, \mathbb{C})$).

11 From shape assignments to cocycles

We now prove that the bottom row of diagram (1-5) consists of one-one correspondences. The idea is to first prove that a shape assignment determines a natural cocycle on each doubly truncated simplex. This is a consequence of the internal gluing equations. The face and edge equations imply that the cocycles glue together to a cocycle on M ; the middle edges glue together because of the face equations, and the edge equations imply that we can fill in the prisms.

Lemma 11.1 *If two shape assignments z and w agree on two faces i and j , then $z = w$, ie if $z_s^e = w_s^e$ when $e_i = s_i = 0$ or $e_j = s_j = 0$, then $z_s^e = w_s^e$ for all $(s, e) \in \Delta_{n-2}^3(\mathbb{Z}) \times \dot{\Delta}_2^3(\mathbb{Z})$.*

Proof We may assume that z and w agree on faces 2 and 3. It is enough to prove that $z_s^{1100} = w_s^{1100}$ for all $s = (s_0, s_1, s_2, s_3) \in \Delta_{n-2}^3(\mathbb{Z})$. By assumption, this holds if either s_2 or s_3 is 0. Suppose by induction that $z_s^{1100} = w_s^{1100}$ for all s with $s_2 + s_3 < k$, and let $s \in \Delta_{n-2}^3(\mathbb{Z})$ be a subsimplex with $s_2 + s_3 = k$. Since the result holds when either s_2 or s_3 is 0, we may assume that $s = \alpha + 0011$, with $\alpha \in \Delta_{n-4}^3(\mathbb{Z})$. Let $t = s + 1100$. By Lemma 6.10, z and w satisfy the internal gluing equations, ie we have

$$(11-1) \quad z_{\alpha+1100}^{0011} z_{\alpha+1010}^{0101} z_{\alpha+1001}^{0110} z_{\alpha+0110}^{1001} z_{\alpha+0101}^{1010} z_s^{1100} = w_{\alpha+1100}^{0011} w_{\alpha+1010}^{0101} w_{\alpha+1001}^{0110} w_{\alpha+0110}^{1001} w_{\alpha+0101}^{1010} w_s^{1100},$$

which equals 1. Note that for all terms except z_s^{1100} and w_s^{1100} , the lower index satisfies $s_2 + s_3 < k$. By induction, each term $z_{\alpha+I}^{1111-I}$ equals $w_{\alpha+I}^{1111-I}$. Hence $z_s^{1100} = w_s^{1100}$, completing the induction. □

Lemma 11.2 *The factorization of the middle edges is unique, ie if*

$$(11-2) \quad \prod_{k=1}^{n-1} \left(\prod_{i=1}^{n-k} x_i(1) \prod_{i=1}^{n-k-1} H_i(a_{k,i}) \right) = \prod_{k=1}^{n-1} \left(\prod_{i=1}^{n-k} x_i(1) \prod_{i=1}^{n-k-1} H_i(b_{k,i}) \right),$$

then $a_{k,i} = b_{k,i}$ for all k, i .

Proof Suppose (11-2) holds. In particular, all diagonal entries are equal. Hence, as in Remark 10.17, the equality $\prod_{i=l}^{n-2} \prod_{k=1}^{n-1-i} a_{k,i} = \prod_{i=l}^{n-2} \prod_{k=1}^{n-1-i} b_{k,i}$ holds for all $l = 1, \dots, n$. The result now follows by induction. \square

Proposition 11.3 *The map \mathcal{Z} from generic decorations on Δ_n^3 to shape assignments on Δ_n^3 is surjective.*

Proof Let z be a shape assignment. We wish to construct a decoration D with $\mathcal{Z}(D) = z$. Let $D = (B, q_1 B, \beta_{012} q_1 B, \gamma_{012} \beta_{013} q_1 B)$ and let $z' = \mathcal{Z}(D)$. By Lemma 11.1, it is enough to prove that z' agrees with z on faces 2 and 3. We prove this for face 3 ($s_3 = 0$), face 2 being similar. We use induction on s_2 . Let β' and γ' denote the labelings of the natural cocycle of D . Let X_t and X'_t denote the X -coordinates of z and z' . Note that $\beta'_{012} = \beta_{012}$ and $\gamma'_{012} = \gamma_{012}$. Since $\gamma'_{012} = \gamma_{012}$, the equality $z_s^{1100} = w_s^{1100}$ holds for $s_2 = 0$, proving the base case. Since $\beta'_{012} = \beta_{012}$, it follows from Lemma 11.2 that $X_t = X'_t$ for all t on faces 2 and 3. Now suppose by induction that $z_s^{1100} = w_s^{1100}$ holds for $s_2 < k$. Let $t = s + 1100$. We have

$$(11-3) \quad -z_s^{1100} z_{t-1010}^{1010} z_{t-0110}^{0110} = X_t = X'_t = -z'_s{}^{1100} z'_{t-1010}{}^{1010} z'_{t-0110}{}^{0110}.$$

By induction, $z_{t-1010}^{1010} = z'_{t-1010}{}^{1010}$ and $z_{t-0110}^{0110} = z'_{t-0110}{}^{0110}$, so we must also have $z_s^{1100} = z'_s{}^{1100}$. This proves the result. \square

Theorem 11.4 *The bottom row of diagram (1-5) consists of one-one correspondences.*

Proof We first prove this for a simplex. The map $\mathcal{L}_{\alpha\beta\gamma}$ is bijective by Remark 9.14. The injectivity of \mathcal{Z} follows from Theorem 10.14, and surjectivity was proved in Proposition 11.3. Now suppose z is a shape assignment on (M, \mathcal{T}) . We must prove that z determines a generic decoration, or equivalently a natural cocycle. By Proposition 11.3, z determines a natural cocycle on each doubly truncated simplex. We must prove that these fit together to form a cocycle on M . The labelings of long edges obviously match up, and by (10-23) and Remark 10.10, the middle edges match up if and only if the face equations are satisfied. Now all that is left to prove is that the induced labeling on the prisms are cocycles. This is a direct consequence of the edge equations. \square

Remark 11.5 It follows from Theorem 11.4 that (10-23) gives an explicit map from shape assignments to cocycles. Combined with Remark 9.14 this gives explicit inverses of \mathcal{Z} and $\mathcal{L}_{\alpha\beta\gamma}$. Similarly, we have explicit inverses of \mathcal{C} and $\mathcal{L}_{\alpha\beta}$ via (10-5).

12 Duality

In this section we make some observations about the relationship between the shape coordinates and the Ptolemy coordinates. Our observations suggest that there is a fundamental duality between the two sets of coordinates, which is interesting in its own right. We believe that this duality is a 3–dimensional aspect of the duality (see [12, page 33]) between \mathcal{A} –coordinates and \mathcal{X} –coordinates on higher Teichmüller space of a simply connected Lie group (eg $SL(n, \mathbb{C})$), respectively, its Langlands dual group (eg $PGL(n, \mathbb{C})$).

Note that for each subsimplex, one shape parameter determines the other two. We single out one:

Definition 12.1 We call the parameters z_s^{1100} *shape coordinates*.

As is customary for $n = 2$, we can write the gluing equations entirely in terms of the shape coordinates. Let $sub_n(\mathcal{T})$ denote the set of all subsimplices of the simplices of \mathcal{T} .

Observation 12.2 (Duality) The coordinates and their relations are parametrized by the following sets:

Ptolemy coordinates $\dot{\mathcal{T}}_n(\mathbb{Z})$	shape coordinates $sub_n(\mathcal{T})$
Ptolemy relations $sub_n(\mathcal{T})$	gluing equations $\dot{\mathcal{T}}_n(\mathbb{Z})$

In particular, we have

$$(12-1) \quad \begin{aligned} \#\{\text{Ptolemy coordinates}\} &= \#\{\text{Gluing equations}\}, \\ \#\{\text{Ptolemy relations}\} &= \#\{\text{Shape coordinates}\}. \end{aligned}$$

Proposition 12.3 *If all boundary components of M are tori, we have*

$$(12-2) \quad \#\left\{ \begin{array}{l} \text{Ptolemy} \\ \text{coords} \end{array} \right\} = \#\left\{ \begin{array}{l} \text{Ptolemy} \\ \text{relations} \end{array} \right\} = \#\left\{ \begin{array}{l} \text{Shape} \\ \text{coords} \end{array} \right\} = \#\left\{ \begin{array}{l} \text{Gluing} \\ \text{equations} \end{array} \right\} = \binom{n+1}{3} t,$$

where t is the number of simplices of \mathcal{T} .

Proof This follows immediately from Lemma 7.6. □

13 The cusp equations

The decomposition of M into doubly truncated simplices and prisms induces a polyhedral decomposition of ∂M . Note that every closed curve in ∂M is homotopic to an edge path in this decomposition.

Let σ be a natural $(\text{PGL}(n, \mathbb{C}), B, H)$ -cocycle on M . By Remark 10.19, the restriction of σ to ∂M has a canonical lift (also denoted by σ) to a cocycle with values in $B \subset \text{GL}(n, \mathbb{C})$.

Definition 13.1 Let λ be a closed edge path in ∂M and let β_1, \dots, β_r and $\gamma_1, \dots, \gamma_s$ be the labelings induced by σ of the middle, respectively, short edges traversed by λ . For $l = 1, \dots, n - 1$, the *level l cusp equation* of λ is the equation

$$(13-1) \quad \prod_{j=1}^r (\beta_j)_{ll} \prod_{j=1}^s (\gamma_j)_{ll} = 1,$$

where the subscript ll denotes the l^{th} diagonal entry.

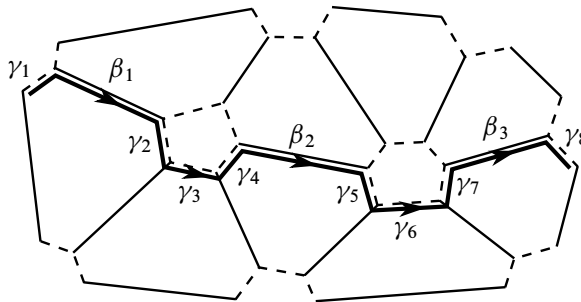

Figure 20: A curve in the polyhedral decomposition of ∂M

Lemma 13.2 *The representation ρ determined (up to conjugation) by σ is boundary-unipotent if and only if the cusp equation at each level is satisfied for each edge path representing a generator of the fundamental group of a boundary component of ∂M .*

Proof By definition, ρ is boundary-unipotent if and only if for each closed edge path λ in ∂M , the product of the labelings of edges traversed by λ is in N . This proves the result. □

Remark 13.3 Note that for $n = 2$ we recover the traditional cusp equations.

13.1 Simplifying the cusp equations

Lemma 13.4 *The cusp equations are equivalent to the equations*

$$(13-2) \quad \prod_{j=1}^r \frac{(\beta_j)_{ll}}{(\beta_j)_{l+1,l+1}} \prod_{j=1}^s \frac{(\gamma_j)_{ll}}{(\gamma_j)_{l+1,l+1}} = 1.$$

Moreover, each factor is given by an expression of the form

$$(13-3) \quad \frac{(\beta_j)_{ll}}{(\beta_j)_{l+1,l+1}} = - \prod_{k=1}^{n-1-l} X_{k,l,\Delta}^{\varepsilon_{\cup}^{v_0 v_1 v_2}}, \quad \frac{(\gamma_j)_{ll}}{(\gamma_j)_{l+1,l+1}} = z_{l,\Delta}^{-\varepsilon_{\cup}^{v_0 v_1 v_2}},$$

where $v_0 v_1 v_2$ is the starting vertex of β_j , respectively, γ_j and Δ is the corresponding simplex.

Proof Equation (13-2) follows from the fact that the n^{th} diagonal entry is 1 for both short and middle edges. By Remark 10.17, the diagonal entries are expressions of the form

$$(13-4) \quad (\beta_j)_{ll} = (-1)^{n-l} \prod_{i=l}^{n-2} \prod_{k=1}^{n-1-i} X_{k,i}^{\varepsilon_{\cup}^{v_0 v_1 v_2}}, \quad (\gamma_j)_{ll} = \prod_{i=l}^{n-1} z_i^{-\varepsilon_{\cup}^{v_0 v_1 v_2}}.$$

Taking quotients, this proves the result. □

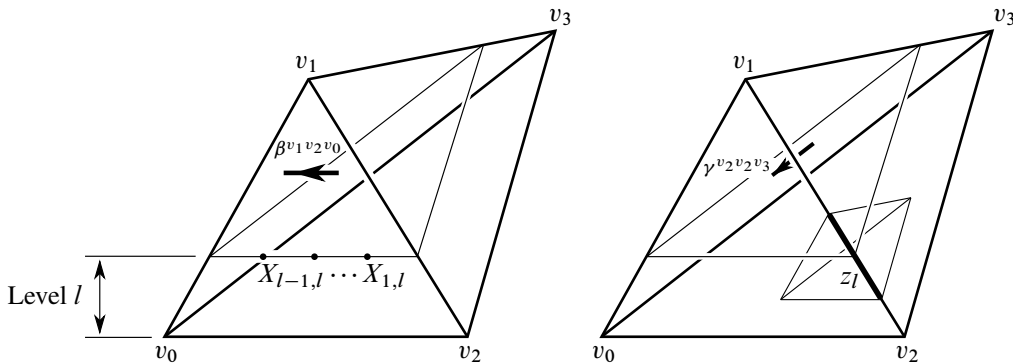

Figure 21: The terms in the simplified cusp equations at level l

Remark 13.5 Note that the contribution from a middle edge is (minus) the product of the X -coordinates at level l . The contribution from a short edge is the shape coordinate at level l . See Figure 21.

Remark 13.6 Note that the cusp equations can be written in the form (1-3).

14 Example: The figure-eight knot

Consider the triangulation of the figure-eight knot complement given in Figure 1. Figure 22 shows the induced triangulation of the link of the ideal vertex and indicates two peripheral curves μ and λ generating the peripheral fundamental group. These are *not* the standard meridian and longitude of the knot. The shape, respectively, X -coordinates of the left simplex are denoted by z_s^e and X_t , whereas those for the right simplex are denoted by w_s^e and Y_t .

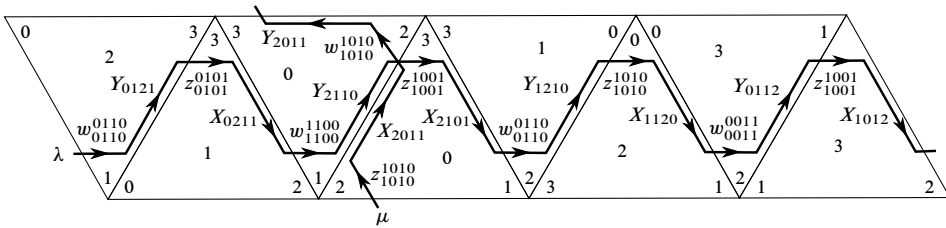

Figure 22: Generators of the peripheral fundamental group of the figure-eight knot complement. The indicated coordinates are those involved in the cusp equations at level $l = 2$ for $n = 4$.

We first consider the gluing equations for $n = 3$. By examining Figure 1, we see that there are four edge points, giving rise to the gluing equations

$$\begin{aligned}
 & z_{0100}^{0101} z_{0100}^{0110} z_{1000}^{1010} (w_{1000}^{1100})^{-1} (w_{1000}^{1001})^{-1} (w_{0010}^{0011})^{-1} = 1, \\
 & z_{0001}^{0101} z_{0010}^{0110} z_{0010}^{1010} (w_{0100}^{1100})^{-1} (w_{0001}^{1001})^{-1} (w_{0001}^{0011})^{-1} = 1, \\
 & z_{1000}^{1100} z_{1000}^{1001} z_{0010}^{0011} (w_{0100}^{0101})^{-1} (w_{0100}^{0110})^{-1} (w_{1000}^{1010})^{-1} = 1, \\
 & z_{0100}^{1100} z_{0001}^{1001} z_{0001}^{0011} (w_{0001}^{0101})^{-1} (w_{0010}^{0110})^{-1} (w_{0010}^{1010})^{-1} = 1,
 \end{aligned}
 \tag{14-1}$$

and four face points, giving rise to the equations

$$\begin{aligned}
 & z_{0010}^{1100} z_{1000}^{0110} z_{0100}^{1010} (w_{1000}^{0011})^{-1} (w_{0010}^{1001})^{-1} (w_{0001}^{1010})^{-1} = 1, \\
 & z_{1000}^{0101} z_{0100}^{1001} z_{0001}^{1100} (w_{0100}^{0011})^{-1} (w_{0010}^{0101})^{-1} (w_{0001}^{0110})^{-1} = 1, \\
 & z_{0100}^{0011} z_{0010}^{0101} z_{0001}^{0110} (w_{1000}^{0101})^{-1} (w_{0100}^{1001})^{-1} (w_{0001}^{1100})^{-1} = 1, \\
 & z_{1000}^{0011} z_{0010}^{1001} z_{0001}^{1010} (w_{1000}^{0110})^{-1} (w_{0100}^{1010})^{-1} (w_{0010}^{1100})^{-1} = 1.
 \end{aligned}
 \tag{14-2}$$

The cusp equations for λ are

$$(14-3) \quad \begin{aligned} &w_{0100}^{0110} Y_{0111} z_{0001}^{0101} X_{0111} w_{0100}^{1100} Y_{1110} z_{0001}^{1001} X_{1101} \\ &\quad \times w_{0010}^{0110} Y_{1110} z_{1000}^{1010} X_{1110} w_{0010}^{0011} Y_{0111} z_{1000}^{1001} X_{1011} = 1, \\ &w_{0010}^{0110} z_{0100}^{0101} w_{1000}^{1100} z_{1000}^{1001} w_{0100}^{0110} z_{0010}^{1010} w_{0001}^{0011} z_{0001}^{1001} = 1, \end{aligned}$$

and the cusp equations for μ are

$$(14-4) \quad \begin{aligned} &z_{0010}^{1010} X_{1011} w_{0010}^{1010} Y_{1011} = 1, \\ &z_{1000}^{1010} w_{1000}^{1010} = 1. \end{aligned}$$

Using Magma [2] to compute the primary decomposition of the ideal generated by the above equations (together with the shape parameter relations (4-4), the formula (10-13) for the X -coordinates in terms of the shapes, and an extra equation making sure that none of the shapes are 0 and 1) we obtain four zero-dimensional algebraic components displayed below. For notational convenience, we write $z_i = z_{e_i}^{1100}$ (similarly for w).

$$(14-5) \quad \begin{cases} z_0 = w_3 + \frac{3}{2}, & z_1 = \frac{1}{2}w_3 + \frac{1}{2}, & z_2 = -\frac{1}{2}w_3 + \frac{1}{4}, & z_3 = -w_3 + 1, \\ w_0 = -w_3 - \frac{1}{2}, & w_1 = 2w_3 + 2, & w_2 = -2w_3 + 1, & w_3^2 + \frac{1}{2}w_3 + \frac{1}{2} = 0. \end{cases}$$

$$(14-6) \quad \begin{cases} z_0 = -w_3 + 1, & z_1 = w_3, & z_2 = w_3, & z_3 = -w_3 + 1, \\ w_0 = w_3, & w_1 = -w_3 + 1, & w_2 = -w_3 + 1, & w_3^2 - w_3 + 1 = 0. \end{cases}$$

$$(14-7) \quad \begin{cases} z_0 = w_3 - \frac{3}{2}, & z_1 = -2w_3 + 4, & z_2 = 2w_3 - 1, & z_3 = -w_3 + 1, \\ w_0 = -w_3 + \frac{5}{2}, & w_1 = -\frac{1}{2}w_3 + 1, & w_2 = \frac{1}{2}w_3 - \frac{1}{4}, & w_3^2 - \frac{5}{2}w_3 + 2 = 0. \end{cases}$$

$$(14-8) \quad \begin{cases} z_0 = z_1 = z_2 = z_3 = -w_3 + 1, & w_0 = w_1 = w_2 = w_3, & w_3^2 - w_3 + 1 = 0. \end{cases}$$

Remark 14.1 Note that the first and third components are defined over $\mathbb{Q}(\sqrt{-7})$, whereas the second and fourth are defined over $\mathbb{Q}(\sqrt{-3})$. The fourth component corresponds to the representation arising from the geometric representation via the canonical irreducible map $\text{PSL}(2, \mathbb{C}) \rightarrow \text{SL}(3, \mathbb{C})$. The fact that for this component the shapes of all subsimplices are equal for both of the simplices is a general phenomenon; see [16, Theorem 11.3].

Remark 14.2 All representations except for the second component lift uniquely to boundary-unipotent representations in $\text{SL}(3, \mathbb{C})$, so these are also detected by the Ptolemy variety. Components of boundary-unipotent $\text{PGL}(n, \mathbb{C})$ -representations that don't lift to $\text{SL}(n, \mathbb{C})$ -representations seem to be quite common.

The gluing equations for $n = 4$ are shown below.

$$\text{Face A} \quad \begin{cases} z_{2000}^{0110} z_{1100}^{1010} z_{1010}^{1100} (w_{2000}^{0011})^{-1} (w_{1010}^{1001})^{-1} (w_{1001}^{1010})^{-1} = 1 \\ z_{1100}^{0110} z_{0200}^{1010} z_{0110}^{1100} (w_{1010}^{0011})^{-1} (w_{0020}^{1001})^{-1} (w_{0011}^{1010})^{-1} = 1 \\ z_{1010}^{0110} z_{0110}^{1010} z_{0020}^{1100} (w_{1001}^{0011})^{-1} (w_{0011}^{1001})^{-1} (w_{0002}^{1010})^{-1} = 1 \end{cases}$$

$$\text{Face B} \quad \begin{cases} z_{2000}^{0101} z_{1100}^{1001} z_{1001}^{1100} (w_{0200}^{0011})^{-1} (w_{0110}^{0101})^{-1} (w_{0101}^{0110})^{-1} = 1 \\ z_{1100}^{0101} z_{0200}^{1001} z_{0101}^{1100} (w_{0110}^{0011})^{-1} (w_{0020}^{0101})^{-1} (w_{0011}^{0110})^{-1} = 1 \\ z_{1001}^{0101} z_{0101}^{1001} z_{0002}^{1100} (w_{0101}^{0011})^{-1} (w_{0011}^{0101})^{-1} (w_{0002}^{0110})^{-1} = 1 \end{cases}$$

$$\text{Face C} \quad \begin{cases} z_{0200}^{0011} z_{0110}^{0101} z_{0101}^{0110} (w_{2000}^{0101})^{-1} (w_{1100}^{1001})^{-1} (w_{1001}^{1100})^{-1} = 1 \\ z_{0110}^{0011} z_{0020}^{0101} z_{0011}^{0110} (w_{1100}^{0101})^{-1} (w_{0200}^{1001})^{-1} (w_{0101}^{1100})^{-1} = 1 \\ z_{0101}^{0011} z_{0011}^{0101} z_{0002}^{0110} (w_{1001}^{0101})^{-1} (w_{0101}^{1001})^{-1} (w_{0002}^{1100})^{-1} = 1 \end{cases}$$

$$\text{Face D} \quad \begin{cases} z_{2000}^{0011} z_{1010}^{1001} z_{1001}^{1010} (w_{2000}^{0110})^{-1} (w_{1100}^{1010})^{-1} (w_{1010}^{1100})^{-1} = 1 \\ z_{1010}^{0011} z_{0020}^{1001} z_{0011}^{1010} (w_{1100}^{0110})^{-1} (w_{0020}^{1010})^{-1} (w_{0110}^{1100})^{-1} = 1 \\ z_{1001}^{0011} z_{0011}^{1001} z_{0002}^{1010} (w_{1010}^{0110})^{-1} (w_{0002}^{1010})^{-1} (w_{0020}^{1100})^{-1} = 1 \end{cases}$$

$$\text{Edge } \rightarrow \quad \begin{cases} z_{2000}^{1010} z_{0200}^{0110} z_{0200}^{0101} (w_{2000}^{1100})^{-1} (w_{2000}^{1001})^{-1} (w_{0020}^{0011})^{-1} = 1 \\ z_{1010}^{1010} z_{0110}^{0110} z_{0101}^{0101} (w_{1100}^{1100})^{-1} (w_{1001}^{1001})^{-1} (w_{0011}^{0011})^{-1} = 1 \\ z_{0020}^{1010} z_{0020}^{0110} z_{0002}^{0101} (w_{0200}^{1100})^{-1} (w_{0002}^{1001})^{-1} (w_{0002}^{0011})^{-1} = 1 \end{cases}$$

$$\text{Edge } \rightarrow \rightarrow \quad \begin{cases} z_{2000}^{1100} z_{2000}^{1001} z_{0020}^{0011} (w_{2000}^{1010})^{-1} (w_{0200}^{0110})^{-1} (w_{0200}^{0101})^{-1} = 1 \\ z_{1100}^{1100} z_{1001}^{1001} z_{0011}^{0011} (w_{1010}^{1010})^{-1} (w_{0110}^{0110})^{-1} (w_{0101}^{0101})^{-1} = 1 \\ z_{0200}^{1100} z_{0002}^{1001} z_{0002}^{0011} (w_{0020}^{1010})^{-1} (w_{0020}^{0110})^{-1} (w_{0002}^{0101})^{-1} = 1 \end{cases}$$

Interior equation for z : $z_{1100}^{0011} z_{1010}^{0101} z_{1001}^{0110} z_{0110}^{1001} z_{0101}^{1010} z_{0011}^{1100} = 1$

Interior equation for w : $w_{1100}^{0011} w_{1010}^{0101} w_{1001}^{0110} w_{0110}^{1001} w_{0101}^{1010} w_{0011}^{1100} = 1$

Cusp equations for μ :

Level $l = 1$ $z_{0020}^{1010} X_{1021} X_{1012} w_{0020}^{1010} Y_{1021} Y_{1012} = 1$

Level $l = 2$ $z_{1010}^{1010} X_{2011} w_{1010}^{1010} Y_{2011} = 1$

Level $l = 3$ $z_{2000}^{1010} w_{2000}^{1010} = 1$

Cusp equations for λ :

Level $l = 1$

$$w_{0200}^{0110} Y_{0112} Y_{0211} z_{0002}^{0101} X_{0112} X_{0121} w_{0200}^{1100} Y_{1120} Y_{1210} z_{0002}^{1001} X_{1102} X_{1201} \\ \times w_{0020}^{0110} Y_{1120} Y_{2110} z_{2000}^{1010} X_{1210} X_{2110} w_{0020}^{0011} Y_{0121} Y_{0211} z_{2000}^{1001} X_{1021} X_{2011} = 1$$

Level $l = 2$

$$w_{0110}^{0110} Y_{0121} z_{0101}^{0101} X_{0211} w_{1100}^{1100} Y_{2110} z_{1001}^{1001} X_{2101} \\ \times w_{0110}^{0110} Y_{1210} z_{1010}^{1010} X_{1120} w_{0011}^{0011} Y_{0112} z_{1001}^{1001} X_{1012} = 1$$

Level $l = 3$

$$w_{0020}^{0110} z_{0200}^{0101} w_{2000}^{1100} z_{2000}^{1001} w_{0200}^{0110} z_{0020}^{1010} w_{0002}^{0011} z_{0002}^{1001} = 1$$

References

- [1] **N Bergeron, E Falbel, A Guilloux**, *Tetrahedra of flags, volume and homology of SL(3)* arXiv:1101.2742
- [2] **W Bosma, J Cannon, C Playoust**, *The Magma algebra system, I: The user language*, J. Symbolic Comput. 24 (1997) 235–265 Computational algebra and number theory (London, 1993)
- [3] **M Culler, NM Dunfield, JR Weeks**, *SnapPy, a computer program for studying the geometry and topology of 3-manifolds* <http://snappy.computop.org/>
- [4] **T Dimofte**, *Quantum Riemann surfaces in Chern–Simons theory*, Adv. Theor. Math. Phys. 17 (2013) 479–599
- [5] **T Dimofte, D Gaiotto, S Gukov**, *3-manifolds and 3d indices*, Adv. Theor. Math. Phys. 17 (2013) 975–1076
- [6] **T Dimofte, D Gaiotto, S Gukov**, *Gauge theories labelled by three-manifolds*, Comm. Math. Phys. 325 (2014) 367–419
- [7] **T Dimofte, S Garoufalidis**, *The quantum content of the gluing equations*, Geom. Topol. 17 (2013) 1253–1315
- [8] **E Falbel**, *A spherical CR structure on the complement of the figure eight knot with discrete holonomy*, J. Differential Geom. 79 (2008) 69–110 MR2401419
- [9] **E Falbel, S Garoufalidis, A Guilloux, M Görner, P-V Koseleff, F Rouillier, C Zickert**, *CURVE Database of representations* <http://curve.unhyperbolic.org/database.html>
- [10] **E Falbel, P V Koseleff, F Rouillier**, *Representations of fundamental groups of 3-manifolds into PGL(3, C): Exact computations in low complexity* arXiv:1307.6697

- [11] **E Falbel, Q Wang**, *A combinatorial invariant for spherical CR structures*, Asian J. Math. 17 (2013) 391–422
- [12] **V Fock, A Goncharov**, *Moduli spaces of local systems and higher Teichmüller theory*, Publ. Math. Inst. Hautes Études Sci. (2006) 1–211 MR2233852
- [13] **S Francaviglia**, *Hyperbolic volume of representations of fundamental groups of cusped 3-manifolds*, Int. Math. Res. Not. 2004 (2004) 425–459 MR2040346
- [14] **S Garoufalidis**, *The 3D index of an ideal triangulation and angle structures* arXiv: 1208.1663
- [15] **S Garoufalidis, C D Hodgson, H Rubinstein, H Segerman**, *1-efficient triangulations and the index of a cusped hyperbolic 3-manifold* arXiv:1303.5278
- [16] **S Garoufalidis, D P Thurston, C K Zickert**, *The complex volume of $\mathrm{SL}(n, \mathbb{C})$ -representations of 3-manifolds* arXiv:1111.2828 to appear in Duke Math. J.
- [17] **S Garoufalidis, C K Zickert**, *The symplectic properties of the $\mathrm{PGL}(n, \mathbb{C})$ -gluing equations* arXiv:1310.2497 to appear in Quantum Topology
- [18] **O Goodman**, *Snap* Available at <http://www.ms.unimelb.edu.au/~snap/>
- [19] **R M Kashaev**, *The hyperbolic volume of knots from the quantum dilogarithm*, Lett. Math. Phys. 39 (1997) 269–275 MR1434238
- [20] **W D Neumann**, *Combinatorics of triangulations and the Chern–Simons invariant for hyperbolic 3-manifolds*, from: “Topology ’90”, (B Apanasov, W D Neumann, A W Reid, L Siebenmann, editors), Ohio State Univ. Math. Res. Inst. Publ. 1, de Gruyter, Berlin (1992) 243–271 MR1184415
- [21] **W D Neumann, D Zagier**, *Volumes of hyperbolic three-manifolds*, Topology 24 (1985) 307–332 MR815482
- [22] **J Porti**, *Torsion de Reidemeister pour les variétés hyperboliques*, 612, Amer. Math. Soc. (1997) MR1396960
- [23] **W P Thurston**, *The geometry and topology of 3-manifolds*, lecture notes, Princeton University (1978–1981) Available at <http://library.msri.org/books/gt3m>
- [24] **J Weeks**, *SnapPea* Available at <http://www.geometrygames.org/SnapPea/index.html>
- [25] **C K Zickert**, *The volume and Chern–Simons invariant of a representation*, Duke Math. J. 150 (2009) 489–532

School of Mathematics, Georgia Institute of Technology
686 Cherry Street, Atlanta, GA 30332-0160, USA

Pixar Animation Studios
1200 Park Avenue, Emeryville, CA 94608, USA

*Department of Mathematics, University of Maryland
College Park, MD 20742-4015, USA*

stavros@math.gatech.edu, enischte@gmail.com, zickert@umd.edu

<http://www.math.gatech.edu/~stavros>, <http://www.unhyperbolic.org/>,
<http://www2.math.umd.edu/~zickert>

Received: 7 November 2014