

AG  
T

*Algebraic & Geometric  
Topology*

Volume 24 (2024)

**Intrinsically knotted graphs with linklessly embeddable simple minors**

THOMAS W MATTMAN

RAMIN NAIMI

ANDREI PAVELESCU

ELENA PAVELESCU





# Intrinsically knotted graphs with linklessly embeddable simple minors

THOMAS W MATTMAN

RAMIN NAIMI

ANDREI PAVELESCU

ELENA PAVELESCU

It has been an open question whether the deletion or contraction of an edge in an intrinsically knotted graph always yields an intrinsically linked graph. We present a new intrinsically knotted graph that shows the answer to both questions is no.

05C10; 57M15, 57K10

## 1 Introduction

A graph is *intrinsically knotted* (resp. *intrinsically linked*) if every embedding of it in  $S^3$  contains a nontrivial knot (resp. 2–component link). We abbreviate intrinsically knotted (resp. linked) as IK (resp. IL), and not intrinsically knotted (resp. linked) as nIK (resp. nIL). Robertson, Seymour, and Thomas [12] showed that every IK graph is IL. It is also known that coning one vertex over an IL graph yields an IK graph. (This is shown by combining [12] and the work of Foisy [4] and Sachs [13].) However, it has been difficult to make the relationship between IK and IL graphs stronger. For example, Adams [1] asked if deleting a vertex from an IK graph always yields an IL graph, but Foisy [5] provided a counterexample. Deleting a vertex from a graph also deletes all edges incident to that vertex, so it might seem more likely that deleting, or contracting, a single edge of an IK graph should leave it IL. Naimi, Pavelescu, and Schwartz [10] tried to show that this is the case when the edge belongs to a 3–cycle, but their proof contained an error (which we will describe in Section 6). They also asked if deleting or contracting an edge in an IK graph always yields an IL graph. We verify (using a computer program) that the answer to this question is yes for graphs of order at most 9, but we show that in general the answer is no. We present an IK graph  $G_{11,35}$  of order 11 and size 35 with edges  $e$  and  $f$  such that neither  $G_{11,35} - e$  (edge deletion) nor  $G_{11,35}/f$  (edge contraction) is IL. We argue that  $G_{11,35}$  is a minimal-order example of an IK graph that yields a nIL graph by deleting one edge, and that ten is the smallest order for an IK graph that yields a nIL graph by contracting one edge. The graph  $G_{11,35}$  is also a counterexample to the main result of [10].

Graphs that are IK but yield a nIL graph by deleting one vertex or edge or by contracting one edge are intriguing from the perspective of Colin de Verdière’s graph invariant  $\mu$ . This is an integer-valued graph

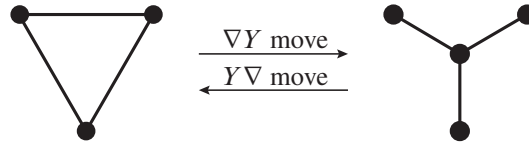
Figure 1:  $\nabla Y$  and  $Y\nabla$  moves.

invariant that is difficult to compute in general; its value is known only for certain classes of graphs with “nice” topological properties. For example, for any graph  $G$ ,  $\mu(G) \leq 3$  if and only if  $G$  is planar (see Colin de Verdière [2]), and  $\mu(G) \leq 4$  if and only if  $G$  is nIL; see van der Holst, Lovász, and Schrijver [7].

An important open question is how to characterize graphs  $G$  with  $\mu(G) \leq 5$ . Even though many known minor-minimal IK (MMIK) graphs have  $\mu$ -invariant 6, intrinsic knottedness is not the answer. A *minor* of a graph  $G$  is a graph obtained by contracting zero or more edges in a subgraph of  $G$ . We’ll say an *edge deletion minor* (resp. *edge contraction minor*) of  $G$  is a graph obtained by deleting (resp. contracting) exactly one edge of  $G$ . Both are called *simple minors* of  $G$ . As we explain in Section 5, if an IK graph  $G$  has a nIL simple minor then  $\mu(G) = 5$ . Thus, our graph  $G_{11,35}$ , together with other IK graphs obtained from it (as described in Section 5), join Foisy’s graph as new examples of IK graphs with  $\mu$ -invariant 5. These examples show that  $\mu(G) \leq 5$  is not equivalent to  $G$  being nIK.

In the next section we describe the graph  $G_{11,35}$  and we show it is IK and minor-minimal for that property in Sections 3 and 4, respectively. In Section 5 we make some observations about the Colin de Verdière invariant and prove that 10 is the least order for an IK graph with an edge-contraction minor that is IL. Section 6 goes over the error in [10], and we conclude with an appendix that provides edge lists for three graphs we discuss.

To complete this introduction, we provide several definitions. A graph  $G$  is  $n$ -*apex* if one can delete  $n$  vertices from  $G$  to obtain a planar graph;  $G$  is *apex* if it is 1-apex, and 0-apex is a synonym for planar. A graph  $G$  is *minor minimal* with respect to a property if  $G$  has that property but no minor of it has that property. The complete graph on  $n$  vertices is denoted by  $K_n$ .  $V(G)$  and  $E(G)$  denote the vertex set and the edge set of  $G$ , respectively. A graph  $G$  is the *clique sum* of two subgraphs  $G_1$  and  $G_2$  over  $K_n$  if  $V(G) = V(G_1) \cup V(G_2)$ ,  $E(G) = E(G_1) \cup E(G_2)$ , and the subgraphs induced in  $G_1$  and  $G_2$  by  $V(G_1) \cap V(G_2)$  are both isomorphic to  $K_n$ . We use the notation  $G = G_1 \oplus_{K_n} G_2$ . The  $\nabla Y$ -move and  $Y\nabla$ -move are defined as shown in Figure 1. The *family* of a graph  $G$  is the set of all graphs obtained from  $G$  by doing zero or more  $\nabla Y$  and  $Y\nabla$  moves. The Petersen family of graphs is the family of the Petersen graph (which is also the family of  $K_6$ ).

## 2 The graph $G_{11,35}$

We describe a sequence of graphs and graph operations used to construct  $G_{11,35}$ . Let  $H$  denote the graph in Figure 2, left. Deleting the vertex labeled 4, one obtains the maximal planar graph  $H'$ , depicted in

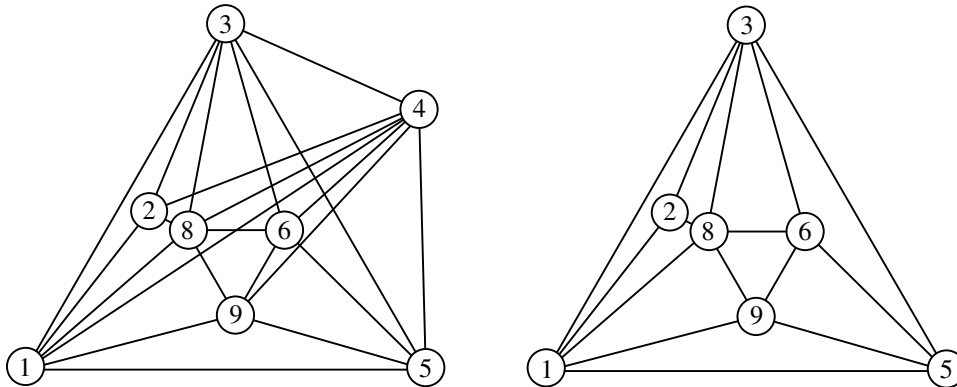

Figure 2: Left:  $H$  is apex. Right:  $H'$  is maximal planar.

Figure 2, right. This implies that  $H$  is an apex graph; thus it is nIL by [13]. Similarly, the graph  $K$  shown in Figure 3, left, is nIL since deleting vertex 5 from  $K$  yields a maximal planar graph, as in Figure 3, right.

Notice that deleting the vertices 3, 4, 5, and 6 from both  $H$  and  $K$  produces connected subgraphs. So, by [9, Lemma 14], the clique sum of  $H$  and  $K$  over the  $K_4$  induced by  $\{3, 4, 5, 6\}$  is a nIL graph, denoted by  $M$  and depicted in Figure 4.

The graph  $G_{11,35}$  is obtained by adding the edge  $(2, 11)$  to the nIL graph  $M$  (see Figure 5). We prove in Section 3 that  $G_{11,35}$  is IK. We have thus obtained an IK graph that has a nIL edge deletion minor. Further, since the edge  $(2, 11)$  is in a 3-cycle in  $G_{11,35}$ , this also gives a counterexample to the main result of [10]. Notice that contracting the edge  $(2, 3)$  in  $G_{11,35}$  yields a graph that is a minor of  $M$ , and therefore nIL. Hence,  $G_{11,35}$  also has a nIL edge contraction minor. The edge list of  $G_{11,35}$  is given in the appendix.

**Remark** The edge  $(2, 3)$  in  $G_{11,35}$  is triangular (ie it belongs to one or more triangles), so contracting it results in the deletion of parallel edges. One can ask whether contracting a nontriangular edge in an IK

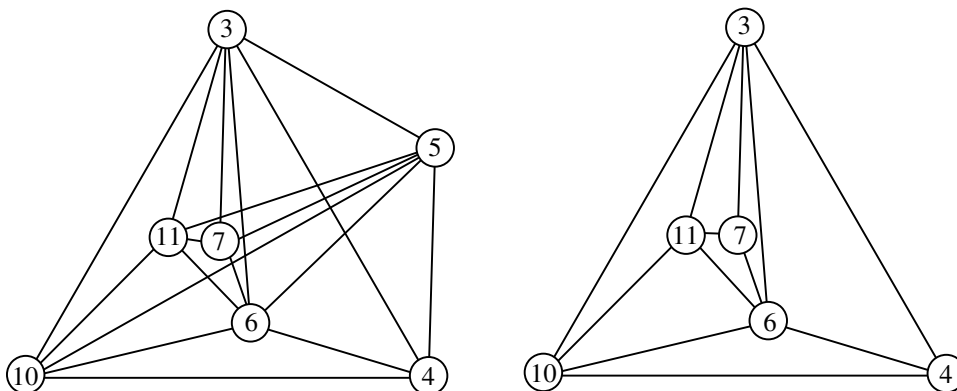

Figure 3: Left:  $K$  is apex. Right:  $K'$  is maximal planar.

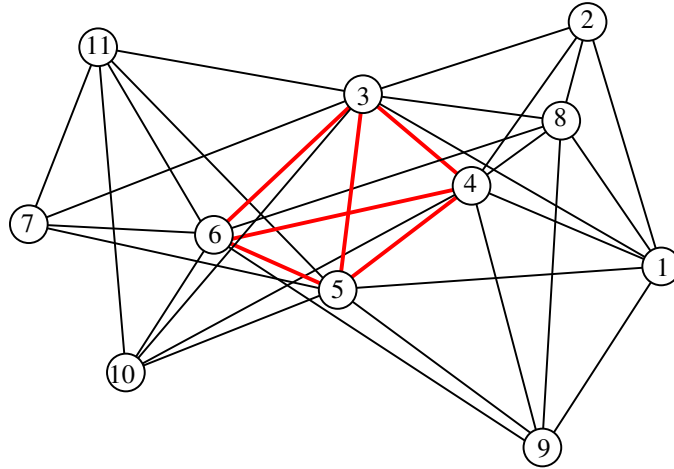

Figure 4:  $M \simeq H \oplus_{K_4} K$ .

graph can result in a nIL graph. The answer is yes: In  $G_{11,35}$ , if we do a  $\nabla Y$  move on the triangle with vertices 2, 3, and 11, we obtain a new IK graph  $G'$  with a new vertex, denoted by  $x$ . Contracting the edge  $(x, 3)$  — which is nontriangular — in  $G'$  yields a graph isomorphic to  $G_{11,35} - (2, 11)$ , which is nIL.

**Remark** The graph  $G_{11,35}$  is a minimal-order IK graph with a nIL edge deletion minor. To verify this, we took every maxnIL graph of order 10 (there are 107 of them [11]), and checked (with computer assistance) that adding one edge to it never yields an IK graph. However, 11 is not the smallest order of an IK graph that has a nIL edge contraction minor. The graph  $G_{10,30}$ , depicted in Figure 6, is a minor-minimal IK graph of order 10. Contracting the edge  $(2, 6)$  gives the nIL minor in Figure 7, left. This graph is

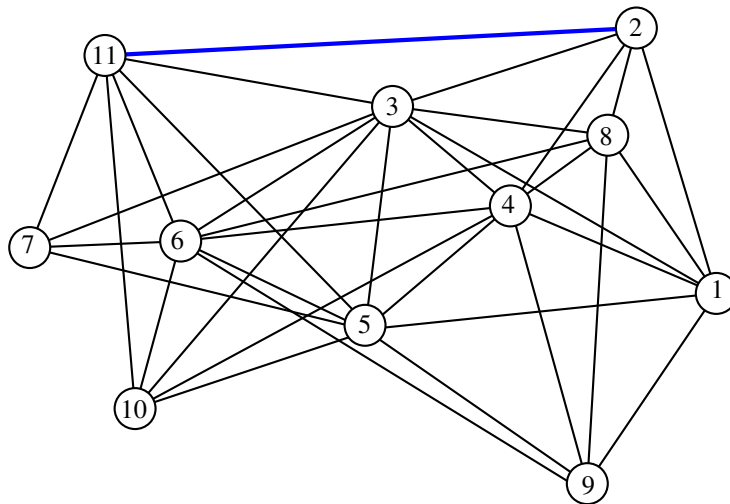

Figure 5: The graph  $G_{11,35}$ .

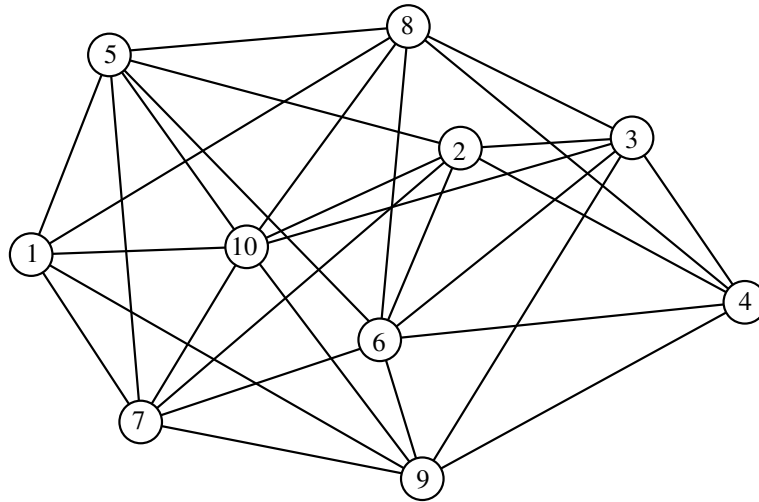

Figure 6: The graph  $G_{10,30}$ .

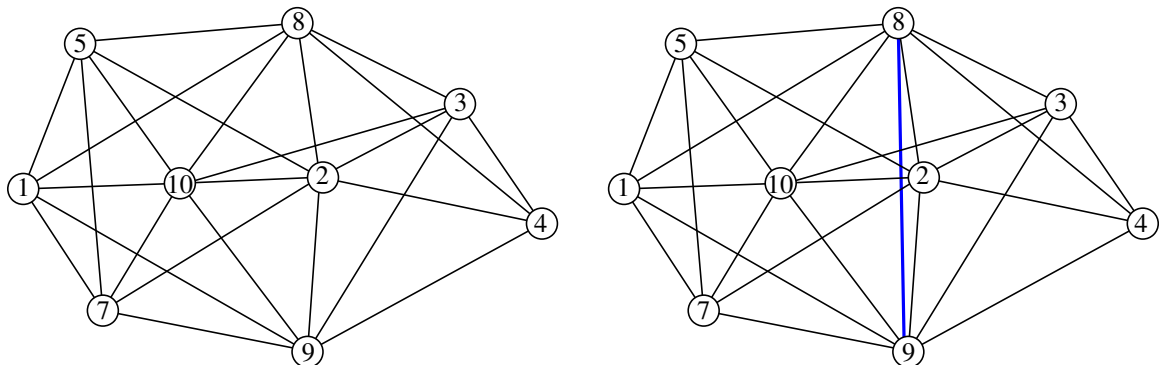

Figure 7: Left: the contraction minor of  $G_{10,30}$ . Right:  $H \oplus_{K_4} K_5$ .

nIL since adding the edge  $(8, 9)$  produces a graph isomorphic to the clique sum, over the  $K_4$  subgraph induced by  $\{2, 3, 8, 9\}$ , of  $K_5$  and a subgraph isomorphic to  $H$ , introduced in Figure 2. By the following proposition,  $G_{10,30}$  is a minimal-order IK graph with a nIL edge contraction minor. In Section 5, we show that  $G_{10,30}$  has  $\mu$ -invariant 5. Furthermore, according to our computer program, this graph is MMIK.

**Proposition 2.1** *Ten is the smallest order for an IK graph which admits a nIL edge contraction minor.*

We defer the proof to Section 5.

### 3 $G_{11,35}$ is IK

We prove  $G_{11,35}$  is IK by showing that the graph  $G_{10,26}$  in Figure 8 is an IK minor of  $G_{11,35}$ . (In fact,  $G_{10,26}$  is MMIK; we show this in the next section.)

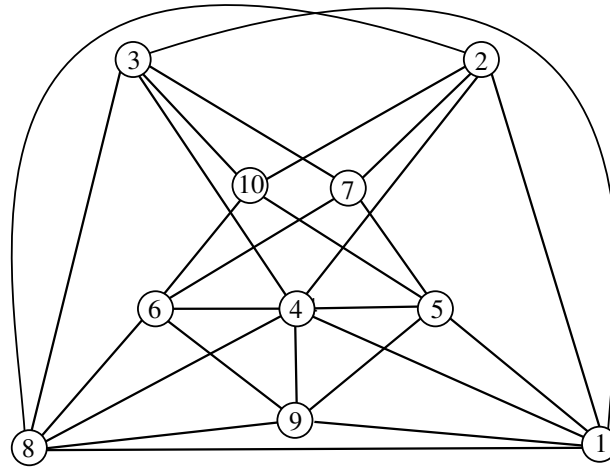

Figure 8:  $G_{10,26}$ .

The graph  $G_{10,26}$  is obtained from  $G_{11,35}$  by contracting the edge  $(2,11)$  and deleting the edges  $(2, 3)$ ,  $(2, 5)$ ,  $(2, 6)$ ,  $(3, 5)$ ,  $(3, 6)$ ,  $(4, 10)$ , and  $(5, 6)$ .

To prove  $G_{10,26}$  is IK, we use the technique developed by Foisy in [4], which we explain below. The  $D_4$  graph is the (multi)graph shown in Figure 9. A *double-linked  $D_4$*  is a  $D_4$  graph embedded in  $S^3$  so that each pair of opposite 2-cycles  $(C_1 \cup C_3$  and  $C_2 \cup C_4)$  has odd linking number. The following lemma was proved by Foisy [4]; a more general version was proved independently by Taniyama and Yasuhara [14].

**Lemma 3.1** *Every double-linked  $D_4$  contains a nontrivial knot.*

We will also use the following (well known and easy to prove) lemma.

**Lemma 3.2** *Suppose  $\alpha$ ,  $\beta_1$ , and  $\beta_2$  are simple closed curves in  $S^3$  such that  $\beta_1 \cap \beta_2$  is an arc and  $\alpha$  has odd linking number with  $(\beta_1 \cup \beta_2) \setminus \text{interior}(\beta_1 \cap \beta_2)$ . Then  $\alpha$  has odd linking number with  $\beta_1$  or  $\beta_2$ .*

**Theorem 3.3** *The graph  $G_{10,26}$  in Figure 8 is IK.*

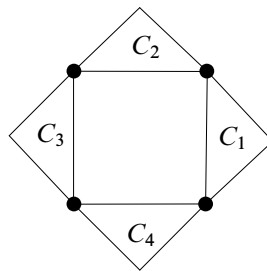

Figure 9: The  $D_4$  graph.



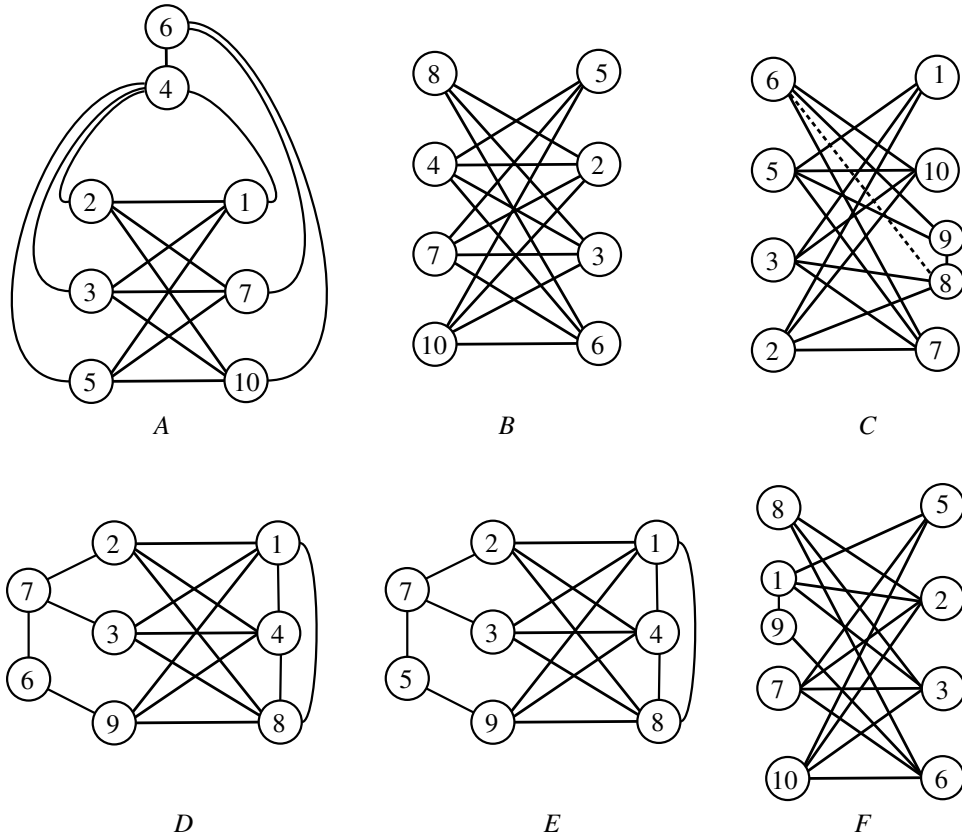

Figure 10: Selected subgraphs of  $G_{10,26}$ .

**Proof** We shall prove that every embedding of  $G_{10,26}$  has a double-linked  $D_4$  minor. It then follows from Lemma 3.1 that  $G_{10,26}$  is IK. For the remainder of this proof, we will say two disjoint simple closed curves  $\alpha$  and  $\beta$  in  $S^3$  are *linked*, or  $\alpha$  *links*  $\beta$ , if  $\alpha \cup \beta$  has odd linking number.

In  $G_{10,26}$  we select the subgraphs  $A$ ,  $B$ ,  $C$ ,  $D$ ,  $E$ , and  $F$  shown in Figure 10 (these are not induced subgraphs). All these subgraphs are either in the Petersen family of graphs or have minors in this family, and are therefore intrinsically linked:  $A$  contains a  $K_{3,3,1}$  minor obtained by contracting the edge  $(4,6)$ ;  $B$  is isomorphic to  $K_{4,4}^-$ ;  $C$  and  $F$  contain  $K_{4,4}^-$  minors obtained by contracting the edges  $(8,9)$  and  $(1,9)$ , respectively;  $D$  and  $E$  contain  $G_7$  minors obtained by contracting the edges  $(6,7)$  and  $(5,7)$ , respectively.

We organize the proof into several cases and subcases, according to which two cycles of each subgraph are linked. We start with the subgraph  $A$ . The vertices of  $G_{10,26}$  can be partitioned into six equivalence classes up to symmetry:  $\{1, 8\}$ ,  $\{2, 3\}$ ,  $\{4\}$ ,  $\{5, 6\}$ ,  $\{7, 10\}$ , and  $\{9\}$ . All of these except vertex 9 are in  $A$ . This gives, up to symmetry, four different pairs of cycles in  $A$ :

- (A1)  $(4, 1, 5) \cup (2, 7, 3, 10)$ ,      (A3)  $(4, 6, 7, 5) \cup (2, 1, 3, 10)$ ,
- (A2)  $(4, 1, 2) \cup (3, 7, 5, 10)$ ,      (A4)  $(4, 6, 7, 2) \cup (3, 1, 5, 10)$ .

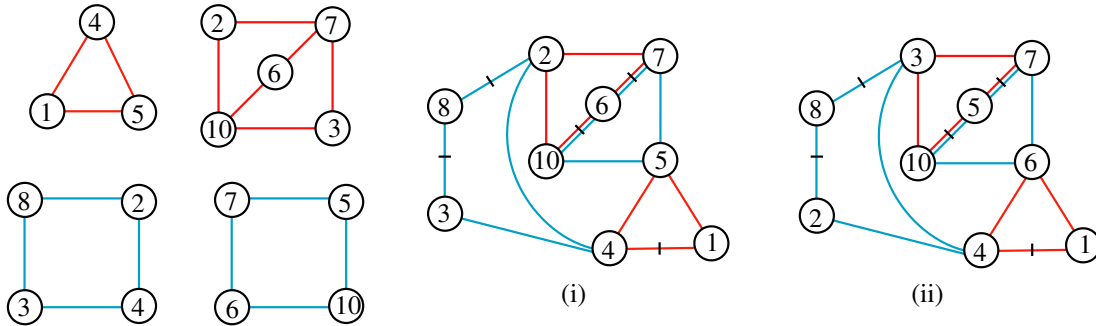

Figure 11: Diagrams for the subcase (A1)-(B1).

Since  $A$  is intrinsically linked, given any embedding of  $G_{10,26}$ , we can relabel (if necessary) the vertices of  $G_{10,26}$  within each equivalence class so that at least one of these four pairs of cycles is linked. We subdivide each of the four cases (A1)–(A4): (A1) is split into subcases according to which two cycles of  $B$  are linked, (A2) according to  $C$ , (A3) according to  $D$ , and (A4) according to  $B$ . For each subcase a diagram is drawn with the nontrivial link in  $A$  drawn in red. The two cycles in each of the subgraphs  $B$  through  $F$  are drawn in blue. Each diagram contains some marked edges; contracting these marked edges in  $G_{10,26}$  gives a double-linked  $D_4$  minor.

**Case (A1)** Assume  $(4, 1, 5) \cup (2, 7, 3, 10)$  is a nontrivial link of  $A$ . We identify a nontrivial link in  $B$  and show the existence of a double-linked  $D_4$  in every subcase. Based on the symmetries of  $G_{10,26}$ ,  $B$  has four different types of pairs of cycles. We match the link in (A1) with each of the four types of links in  $B$ :

$$\begin{aligned} \text{(B1)} \quad & (8, 2, 4, 3) \cup (7, 5, 10, 6), & \text{(B3)} \quad & (8, 2, 7, 6) \cup (4, 5, 10, 3), \\ \text{(B2)} \quad & (8, 2, 7, 3) \cup (4, 5, 10, 6), & \text{(B4)} \quad & (8, 2, 4, 6) \cup (7, 5, 10, 3). \end{aligned}$$

**Subcase (A1)-(B1)** From this point forward, we abbreviate “the cycles  $X$  and  $Y$  are linked” as just “ $X \cup Y$ ”. Assume  $(8, 2, 4, 3) \cup (7, 5, 10, 6)$ . Since  $(4, 1, 5) \cup (2, 7, 3, 10)$ , by Lemma 3.2 we have either (i)  $(4, 1, 5) \cup (2, 7, 6, 10)$  or (ii)  $(4, 1, 5) \cup (3, 7, 6, 10)$ . See Figure 11.

**Subcase (A1)-(B2)** Assume  $(8, 2, 7, 3) \cup (4, 5, 10, 6)$ . See Figure 12, left.

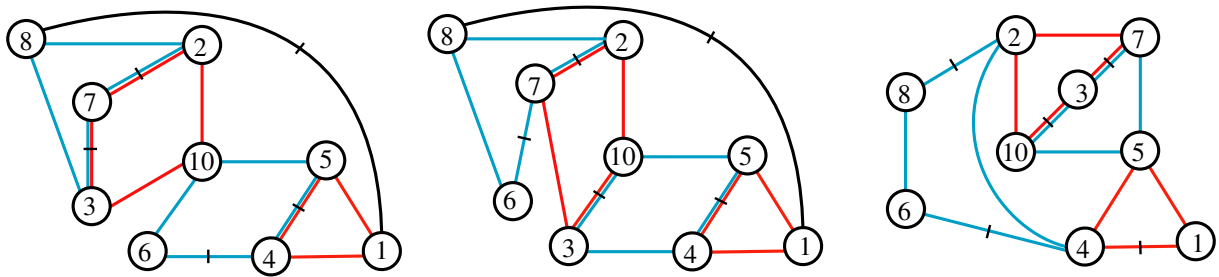

Figure 12: Diagrams for subcases. Left: (A1)-(B2). Center: (A1)-(B3). Right: (A1)-(B4).

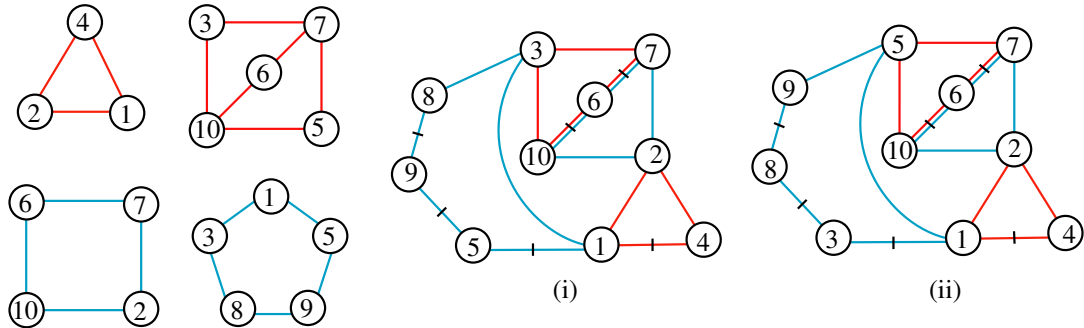

Figure 13: Diagrams for the subcase (A2)-(C1).

**Subcase (A1)-(B3)** Assume  $(8, 2, 7, 6) \cup (4, 5, 10, 3)$ . See Figure 12, center.

**Subcase (A1)-(B4)** Assume  $(8, 2, 4, 6) \cup (7, 5, 10, 3)$ . See Figure 12, right.

**Case (A2)** Assume  $(4, 1, 2) \cup (3, 7, 5, 10)$  is a nontrivial link of  $A$ . We identify a nontrivial link in  $C$  and show the existence of a double-linked  $D_4$ . We note that vertices 8 and 9 and the edge between them act as one vertex of the  $K_{4,4}^-$ . Based on the symmetries of  $G$ ,  $C$  has four different types of pairs of cycles. Since in the (A2) link of  $A$  vertices 2 and 3 are distinguished, they need also be distinguished within the linked cycles of  $C$ . We match the link in (A2) with each link of  $C$ :

- (C1)  $(6, 7, 2, 10) \cup (1, 5, 9, 8, 3)$ ,      (C4)  $(6, 7, 2, 8, 9) \cup (1, 3, 10, 5)$ ,
- (C2)  $(6, 7, 3, 10) \cup (1, 5, 9, 8, 2)$ ,      (C5)  $(6, 7, 3, 8, 9) \cup (1, 2, 10, 5)$ ,
- (C3)  $(6, 7, 5, 10) \cup (1, 2, 8, 3)$ ,      (C6)  $(6, 7, 5, 9) \cup (1, 2, 10, 3)$ .

**Subcase (A2)-(C1)** Assume  $(6, 7, 2, 10) \cup (1, 5, 9, 8, 3)$ . Since  $(4, 1, 2) \cup (3, 7, 5, 10)$ , by Lemma 3.2 we have either (i)  $(4, 1, 2) \cup (3, 7, 6, 10)$  or (ii)  $(4, 1, 2) \cup (5, 7, 6, 10)$ . See Figure 13.

**Subcase (A2)-(C2)** Assume  $(6, 7, 3, 10) \cup (1, 5, 9, 8, 2)$ . See Figure 14, left.

**Subcase (A2)-(C3)** Assume  $(6, 7, 5, 10) \cup (1, 2, 8, 3)$ . See Figure 14, center.

**Subcase (A2)-(C4)** Assume  $(6, 7, 2, 8, 9) \cup (1, 3, 10, 5)$ . See Figure 14, right.

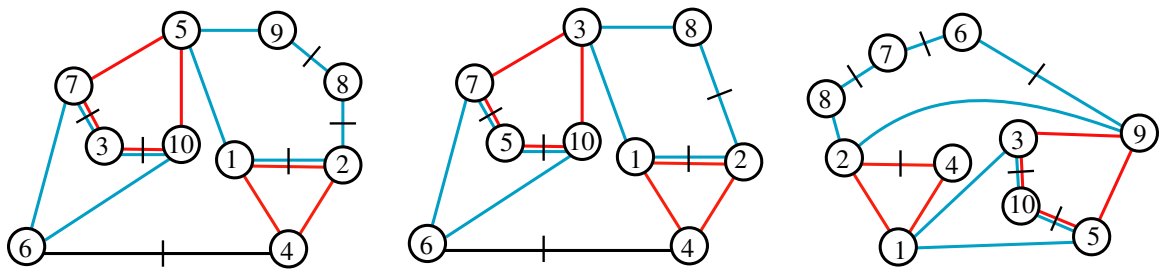

Figure 14: Diagrams for subcases. Left: (A2)-(C2). Center: (A2)-(C3). Right: (A2)-(C4).

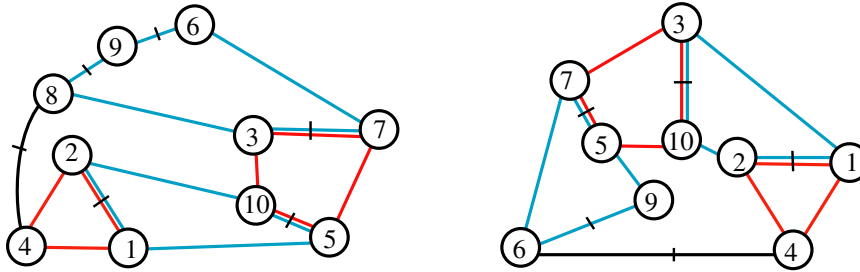

Figure 15: Diagrams for subcases. Left: (A2)-(C5). Right: (A2)-(C6).

**Subcase (A2)-(C5)** Assume  $(6, 7, 3, 8, 9) \cup (1, 2, 10, 5)$ . See Figure 15, left.

**Subcase (A2)-(C6)** Assume  $(6, 7, 3, 8, 9) \cup (1, 2, 10, 5)$ . See Figure 15, right.

**Case (A3)** Assume  $(4, 6, 7, 5) \cup (2, 1, 3, 10)$  is a nontrivial link of  $A$ . We identify a nontrivial link in  $D$  and show the existence of a double-linked  $D_4$  for all cases except one. We then identify a nontrivial link in  $F$  and show the existence of a double-linked  $D_4$  for all cases except one. If both exceptional cases occur at the same time, the existence of a double-linked  $D_4$  is shown.

We note that if the edge  $(6, 7)$  is contracted in the graph  $D$ , a  $G_7$  graph is obtained. Based on the symmetries of  $G$ ,  $D$  has four different types of pairs of cycles. Since the (A3) link of  $A$  contains vertex 1 but does not contain vertex 8, vertices 1 and 8 need also be distinguished within the linked cycles of  $D$ . We match the link in (A3) with each link type of  $D$ :

- (D1)  $(7, 2, 4, 3) \cup (1, 8, 9)$ ,      (D4)  $(7, 2, 1, 9, 6) \cup (4, 3, 8)$ ,
- (D2)  $(7, 2, 1, 3) \cup (4, 8, 9)$ ,      (D5)  $(7, 2, 8, 9, 6) \cup (4, 3, 1)$ ,
- (D3)  $(7, 2, 8, 3) \cup (4, 1, 9)$ ,      (D6)\*  $(7, 2, 4, 9, 6) \cup (1, 3, 8)$ .

**Subcase (A3)-(D1)** Assume  $(7, 2, 4, 3) \cup (1, 8, 9)$ . Then (i)  $(7, 6, 4, 2) \cup (1, 8, 9)$  or (ii)  $(7, 6, 4, 3) \cup (1, 8, 9)$ . See Figure 16.

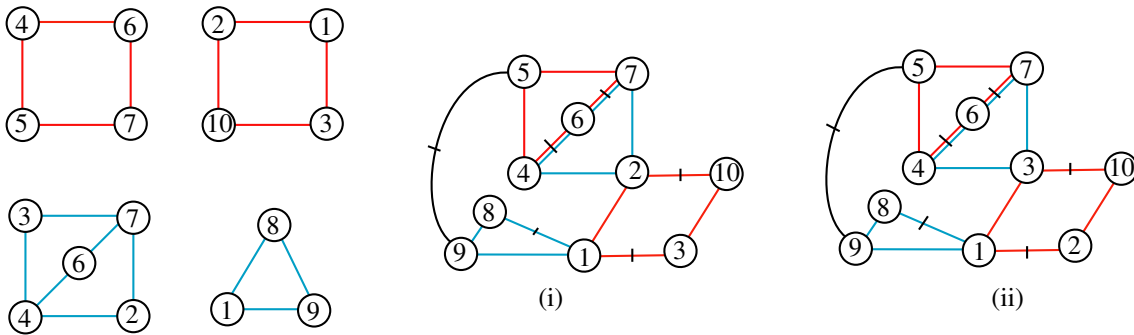

Figure 16: Diagrams for the subcase (A3)-(D1).

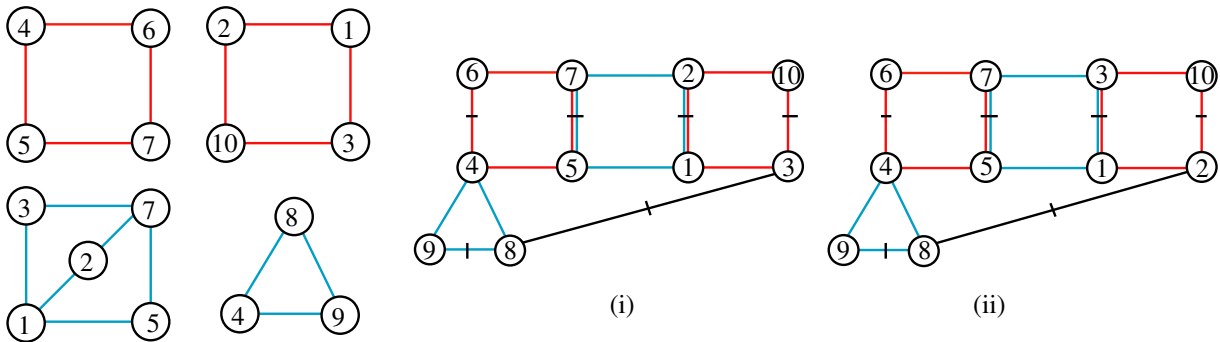

Figure 17: Diagrams for the subcase (A3)-(D2).

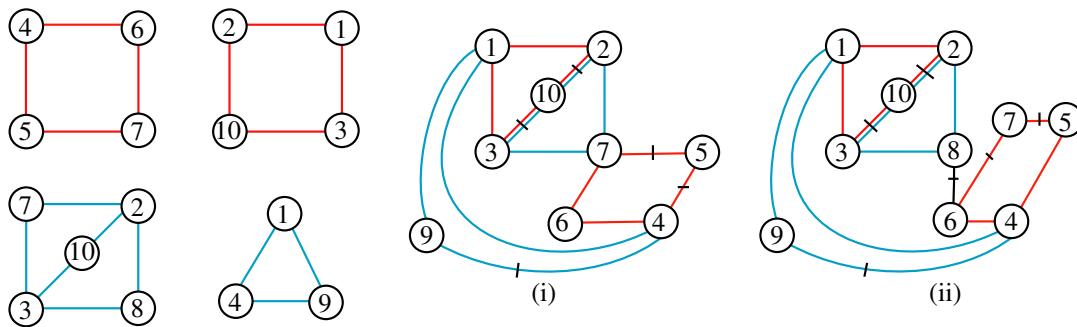

Figure 18: Diagrams for the subcase (A3)-(D3).

**Subcase (A3)-(D2)** Assume  $(7, 2, 1, 3) \cup (4, 8, 9)$ . Then (i)  $(7, 2, 1, 5) \cup (4, 8, 9)$  or (ii)  $(7, 3, 1, 5) \cup (4, 8, 9)$ . See Figure 17.

**Subcase (A3)-(D3)** Assume  $(7, 2, 8, 3) \cup (4, 1, 9)$ . Then (i)  $(7, 2, 10, 3) \cup (4, 1, 9)$  or (ii)  $(8, 2, 10, 3) \cup (4, 1, 9)$ . See Figure 18.

**Subcase (A3)-(D4)** Assume  $(7, 2, 1, 9, 6) \cup (4, 3, 8)$ . See Figure 19, left.

**Subcase (A3)-(D5)** Assume  $(7, 2, 8, 9, 6) \cup (4, 3, 1)$ . See Figure 19, right.

If none of the five D-subcases above occurs, then there exists a nontrivial link (D6)  $(7, 2, 4, 9, 6) \cup (1, 3, 8)$ .

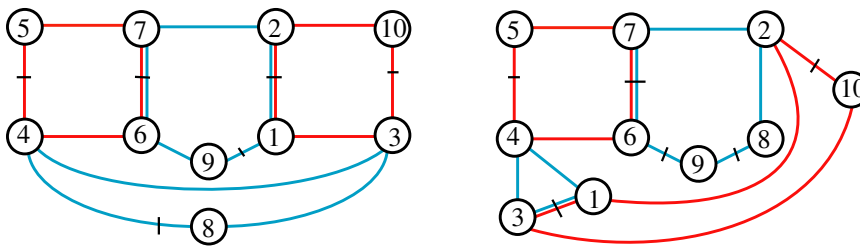

Figure 19: Diagrams for subcases. Left: (A3)-(D4). Right: (A3)-(D5).

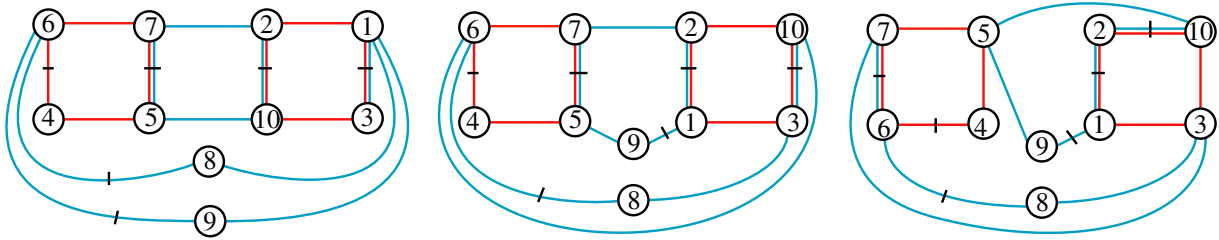

Figure 20: Diagrams for subcases. Left: (A3)-(F1). Center: (A3)-(F2). Right: (A3)-(F3).

We now match the link in (A3) with each link type of  $F$ :

- (F1)  $(5, 7, 2, 10) \cup (3, 1, 9, 6, 8)$ ,      (F4)  $(5, 7, 6, 10) \cup (2, 1, 3, 8)$ ,
- (F2)  $(5, 7, 2, 1) \cup (3, 10, 6, 8)$ ,      (F5)  $(5, 7, 6, 9, 1) \cup (2, 10, 3, 8)$ ,
- (F3)  $(5, 10, 2, 19) \cup (3, 7, 6, 8)$ ,      (F6)\*  $(5, 10, 6, 9, 1) \cup (2, 7, 3, 8)$ .

**Subcase (A3)-(F1)** Assume  $(5, 7, 2, 10) \cup (3, 1, 9, 6, 8)$ . See Figure 20, left.

**Subcase (A3)-(F2)** Assume  $(5, 7, 2, 1) \cup (3, 10, 6, 8)$ . See Figure 20, center.

**Subcase (A3)-(F3)** Assume  $(5, 10, 2, 19) \cup (3, 7, 6, 8)$ . See Figure 20, right.

**Subcase (A3)-(F4)** Assume  $(5, 7, 6, 10) \cup (2, 1, 3, 8)$ . See Figure 21, left.

**Subcase (A3)-(F5)** Assume  $(5, 7, 6, 9, 1) \cup (2, 10, 3, 8)$ . See Figure 21, center.

If none of the five F-subcases solved above occurs, then we have (F6)  $(5, 10, 6, 9, 1) \cup (2, 7, 3, 8)$ . This coupled with the remaining (D6) subcase gives:

**Subcase (D6)-(F6)** Assume  $(7, 2, 4, 9, 6) \cup (1, 3, 8)$  and  $(5, 10, 6, 9, 1) \cup (2, 7, 3, 8)$ . See Figure 21, right.

**Case (A4)** Assume  $(4, 6, 7, 2) \cup (3, 1, 5, 10)$  is a nontrivial link. We look at possible nontrivial links in the graph  $B$ . Based on the symmetries of  $G_{10,26}$ ,  $B$  has four different types of pairs of cycles. Since vertices 2 and 3 and vertices 7 and 10, respectively, are distinguished in the link A4, they need to be distinguished within the cycles of  $B$ . We match the link in (A4) with each link in  $B$ . There is one

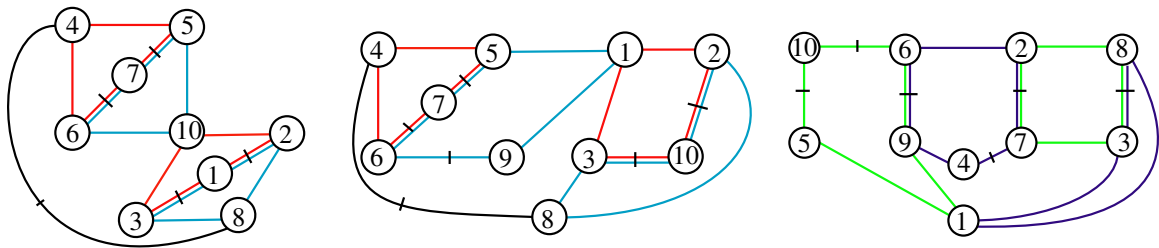

Figure 21: Diagrams for subcases. Left: (A3)-(F4). Center: (A3)-(F5). Right: (D6)-(F6).

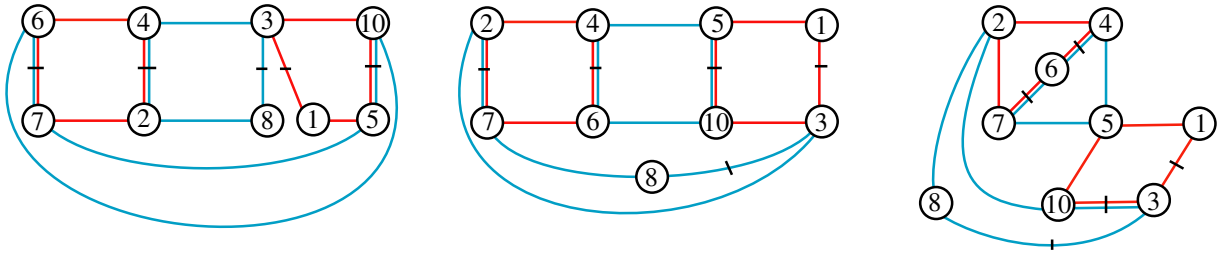

Figure 22: Diagrams for subcases. Left: (A4)-(B1). Center: (A4)-(B2). Right: (A4)-(B3).

exceptional case which cannot be solved this way. Then we look at possible nontrivial links in the graph  $E$  and we match the link in (A4) with each link in  $E$ . There are two exceptional cases which cannot be solved this way. We match the two pairs of exceptional cases to complete the proof.

- (B1)  $(8, 2, 4, 3) \cup (7, 5, 10, 6)$ ,      (B6)  $(8, 3, 10, 6) \cup (4, 5, 7, 2)$ ,
- (B2)  $(8, 2, 7, 3) \cup (4, 5, 10, 6)$ ,      (B7)\*  $(8, 2, 10, 6) \cup (4, 5, 7, 3)$ ,
- (B3)  $(8, 2, 10, 3) \cup (4, 5, 7, 6)$ ,      (B8)  $(8, 2, 4, 6) \cup (7, 5, 10, 3)$ ,
- (B4)  $(8, 2, 7, 6) \cup (4, 5, 10, 3)$ ,      (B9)  $(8, 3, 4, 6) \cup (7, 5, 10, 2)$ ,
- (B5)  $(8, 3, 7, 6) \cup (4, 5, 10, 2)$ .

**Subcase (A4)-(B1)** Assume  $(8, 2, 4, 3) \cup (7, 5, 10, 6)$ . See Figure 22, left.

**Subcase (A4)-(B2)** Assume  $(8, 2, 7, 3) \cup (4, 5, 10, 6)$ . See Figure 22, center.

**Subcase (A4)-(B3)** Assume  $(8, 2, 10, 3) \cup (4, 5, 7, 6)$ . See Figure 22, right.

**Subcase (A4)-(B4)** Assume  $(8, 2, 7, 6) \cup (4, 5, 10, 3)$ . See Figure 23, left.

**Subcase (A4)-(B5)** Assume  $(8, 3, 7, 6) \cup (4, 5, 10, 2)$ . See Figure 23, center.

**Subcase (A4)-(B6)** Assume  $(8, 3, 10, 6) \cup (4, 5, 7, 2)$ . See Figure 23, right.

**Subcase (A4)-(B8)** Assume  $(8, 2, 4, 6) \cup (7, 5, 10, 3)$ . See Figure 24, left.

**Subcase (A4)-(B9)** Assume  $(8, 3, 4, 6) \cup (7, 5, 10, 2)$ . See Figure 24, center.

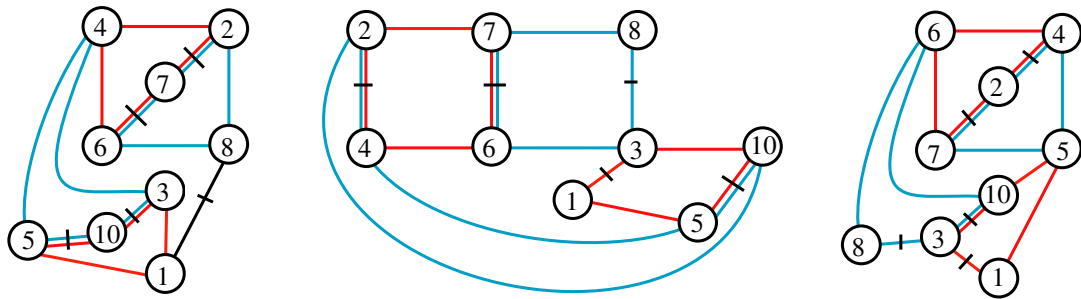

Figure 23: Diagrams for subcases. Left: (A4)-(B4). Center: (A4)-(B5). Right: (A4)-(B6).

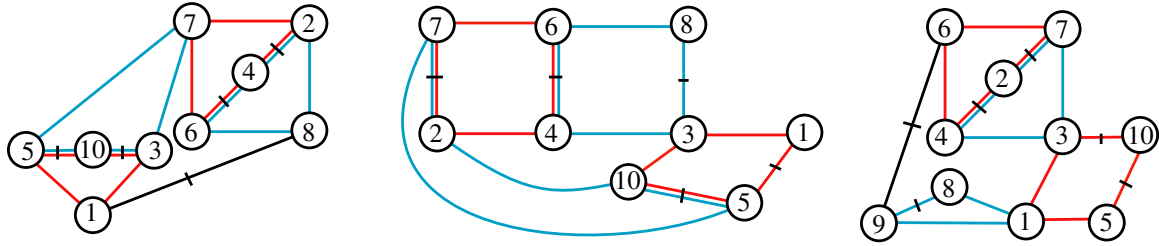

Figure 24: Diagrams for subcases. Left: (A4)-(B8). Center: (A4)-(B9). Right: (A4)-(E1).

We look at possible nontrivial links in the graph  $E$  and we match the link in (A4) with each link in  $E$ :

- (E1)  $(7, 2, 4, 3) \cup (1, 9, 8)$ ,      (E6)  $(7, 2, 1, 9, 5) \cup (4, 3, 8)$ ,
- (E2)  $(7, 2, 1, 3) \cup (4, 9, 8)$ ,      (E7)  $(7, 2, 8, 9, 5) \cup (4, 3, 1)$ ,
- (E3)  $(7, 2, 8, 3) \cup (4, 9, 1)$ ,      (E8)\*  $(7, 3, 8, 9, 5) \cup (4, 2, 1)$ ,
- (E4)  $(7, 2, 4, 9, 5) \cup (3, 1, 8)$ ,      (E9)\*  $(7, 3, 1, 9, 5) \cup (4, 2, 8)$ ,
- (E5)  $(7, 3, 4, 9, 5) \cup (2, 1, 8)$ .

**Subcase (A4)-(E1)** Assume  $(7, 2, 4, 3) \cup (1, 9, 8)$ . See Figure 24, right.

**Subcase (A4)-(E2)** Assume  $(7, 2, 1, 3) \cup (4, 9, 8)$ . See Figure 25, left.

**Subcase (A4)-(E3)** Assume  $(7, 2, 8, 3) \cup (4, 9, 1)$ . See Figure 25, center.

**Subcase (A4)-(E4)** Assume  $(7, 2, 4, 9, 5) \cup (3, 1, 8)$ . See Figure 25, right.

**Subcase (A4)-(E5)** Assume  $(7, 3, 4, 9, 5) \cup (2, 1, 8)$ . Then (i)  $(7, 5, 10, 3) \cup (2, 1, 8)$  or (ii)  $(5, 10, 3, 4, 9) \cup (2, 1, 8)$ . See Figure 26.

**Subcase (A4)-(E6)** Assume  $(7, 2, 1, 9, 5) \cup (4, 3, 8)$ . Then (i)  $(5, 7, 6, 9) \cup (4, 3, 8)$  or (ii)  $(7, 6, 9, 1, 2) \cup (4, 3, 8)$ . See Figure 27.

**Subcase (A4)-(E7)** Assume  $(7, 2, 8, 9, 5) \cup (4, 3, 1)$ . See Figure 28, left.

**Subcase (B7)-(E8)** Assume  $(8, 2, 10, 6) \cup (4, 5, 7, 3)$  and  $(7, 3, 8, 9, 5) \cup (4, 2, 1)$ . See Figure 28, center.

**Subcase (B7)-(E9)** Assume  $(8, 2, 10, 6) \cup (4, 5, 7, 3)$  and  $(7, 3, 1, 9, 5) \cup (4, 2, 8)$ . See Figure 28, right.  $\square$

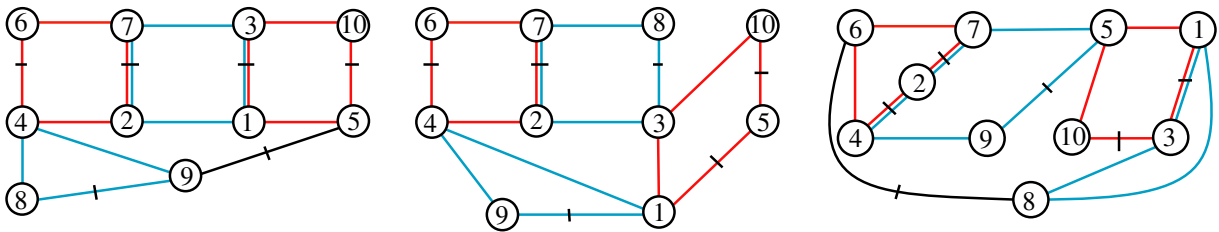

Figure 25: Diagrams for subcases. Left: (A4)-(E2). Center: (A4)-(E3). Right: (A4)-(E4).



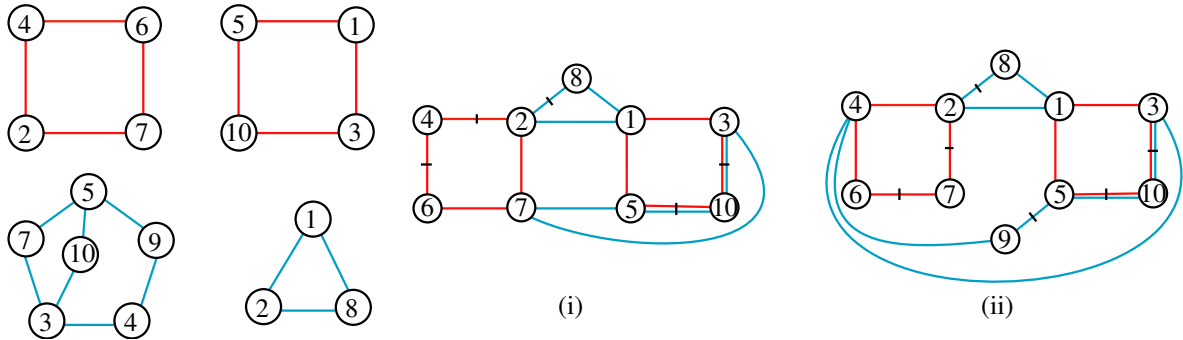

Figure 26: Diagrams for the subcase (A4)-(E5).

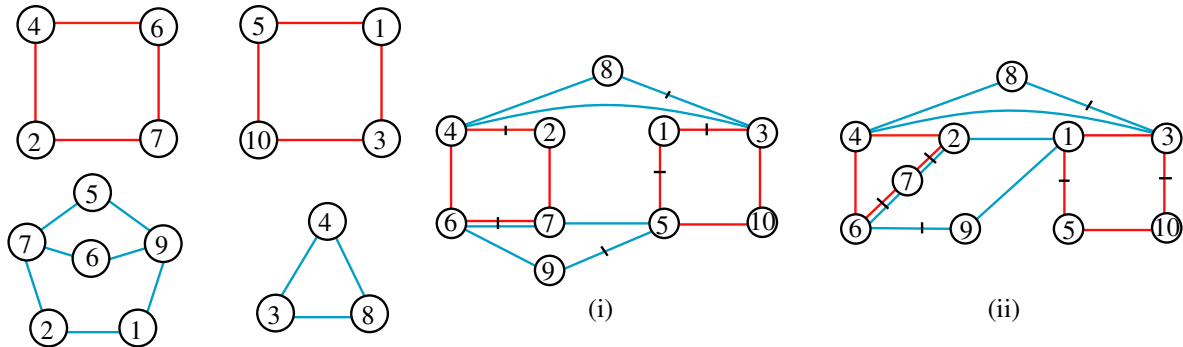

Figure 27: Diagrams for the subcase (A4)-(E6).

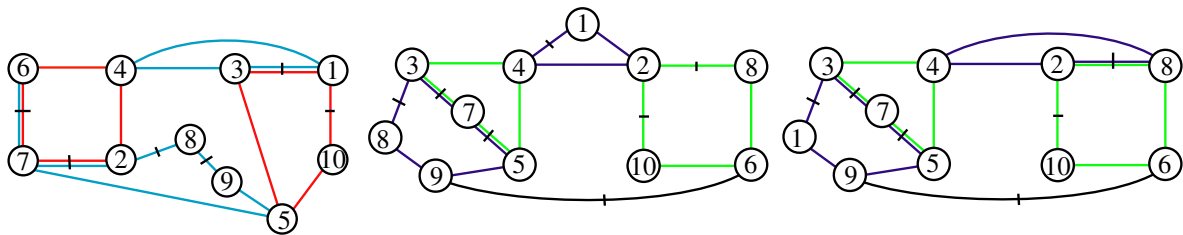

Figure 28: Diagrams for subcases. Left: (A4)-(E7). Center: (B7)-(E8). Right: (B7)-(E9).

### 4 $G_{10,26}$ is MMIK

In this section we prove  $G_{10,26}$  is MMIK by showing that each of its simple minors is nIK. The graph  $G_{10,26}$  has ten vertices, labeled  $1, 2, \dots, 10$ . Due to the symmetries of the graph, the vertices can be partitioned into six equivalence classes:  $\{1, 8\}$ ,  $\{2, 3\}$ ,  $\{4\}$ ,  $\{5, 6\}$ ,  $\{7, 10\}$ , and  $\{9\}$ . Up to symmetry,  $G_{10,26}$  has eleven types of edges. Representatives for each possible type of edge are listed in the first column of Table 1. For each such edge type, we constructed two graphs, one by deleting the edge and one by contracting the edge. The graph obtained by deleting the edge is 2-apex, since the removal of the

edge	deletion	contraction
(1, 2)	4, 7	1, 3
(1, 4)	2, 6	1, 7
(1, 5)	2, 3	1, 2
(1, 8)	2, 3	1, 4
(1, 9)	2, 5	2, 3
(2, 4)	5, 6	2, 3
(2, 7)	3, 4	2, 4
(4, 5)	*	2, 4
(4, 9)	2, 3	4, 7
(5, 7)	2, 4	2, 4
(5, 9)	2, 6	2, 5

Table 1: The graph obtained by deleting the edge in the first column becomes planar when deleting the two vertices in the second column. The graph obtained by contracting the edge in the first column becomes planar when deleting the two vertices in the second column.

two vertices listed in the second column gives a planar graph. There is one exception: the graph obtained by deleting the edge (4, 5) is not 2–apex. This graph is shown to be nIK in the next paragraph. The graph obtained by contracting the edge listed in the first column is 2–apex, since the removal of the two vertices listed in the third column gives a planar graph. When contracting an edge  $e$ , the new vertex inherits the smaller label among the endpoints of  $e$ , and all vertices not incident to  $e$  maintain their labels.

The graph  $G'$  obtained from  $G_{10,26}$  by deleting the edge (4, 5) is not 2–apex. We show it is nIK. Denote by  $G''$  the graph obtained from  $G'$  through a  $\nabla Y$ –move on the triangle (1, 5, 9). Call the new vertex 11;

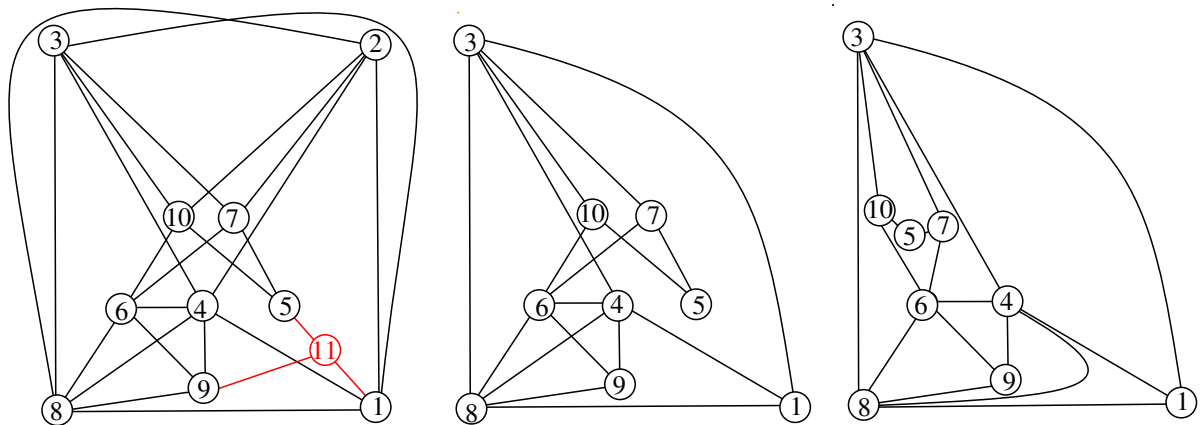

Figure 29: Left: the graph  $G''$  obtained from  $G_{10,26}$  by removing the edge (4, 5) followed by a  $\nabla Y$ –move on the triangle (1, 5, 9). Center: the graph  $G'''$  obtained from  $G''$  by deleting vertices 2 and 11. Right: the planar embedding of  $G'''$ .

see Figure 29. Delete vertices 2 and 11 of  $G''$  to obtain a planar graph. This proves  $G''$  is 2–apex, and thus nIK. Sachs [13] showed that the  $\nabla Y$ –move preserves intrinsic linking. Essentially the same argument shows that the  $\nabla Y$ –move also preserves intrinsic knotting. So the graph  $G'$  is nIK.

## 5 $\mu = 5$ IK graphs

In this section we describe what is known about graphs  $G$  with Colin de Verdière invariant 5. We begin with some basic observations. Let  $K_1 * G$  denote the graph obtained by coning a vertex over  $G$ , ie we add a vertex  $a$  to  $G$  along with edge  $av$  for every  $v \in V(G)$ .

**Lemma 5.1** [7] *Let  $G$  be a graph.*

- (1) *If  $G$  has at least one edge, then  $\mu(K_1 * G) = \mu(G) + 1$ .*
- (2) *If  $G'$  is a minor of  $G$ , then  $\mu(G') \leq \mu(G)$ .*

**Lemma 5.2** [2; 7] (1)  *$\mu(G) \leq 3$  if and only if  $G$  is planar.*

- (2)  *$\mu(G) \leq 4$  if and only if  $G$  is nIL.*

**Lemma 5.3** [7] *If  $\mu(G) \geq 4$  and a  $\nabla Y$  move on  $G$  produces  $G'$ , then  $\mu(G) = \mu(G')$ .*

For  $v \in V(G)$ , let  $G - v$  denote the graph that results after deleting  $v$  and all its edges.

**Lemma 5.4** *If  $G$  is  $n$ –apex for  $n \geq 0$ , then  $\mu(G) \leq n + 3$ .*

**Proof** We use induction on  $n$ . If  $n = 0$ , the result follows from Lemma 5.2. Suppose  $G$  is  $(n+1)$ –apex and  $v \in V$  is such that  $G - v$  is  $n$ –apex. Then  $G$  is a subgraph of  $K_1 * (G - v)$ , and, by Lemma 5.1,  $\mu(G) \leq \mu(G - v) + 1 \leq (n + 1) + 3$ . □

**Lemma 5.5** *If  $G$  is IK and there is a vertex  $v$  such that  $G - v$  is nIL, then  $\mu(G) = 5$ .*

**Proof** Robertson, Seymour, and Thomas [12] established that  $G$  being IK implies  $G$  is IL. By Lemma 5.2,  $\mu(G) \geq 5$  and  $\mu(G - v) \leq 4$ . Since  $G$  is a subgraph of  $K_1 * (G - v)$ , using Lemma 5.1,  $\mu(G) \leq 5$ . □

For  $e \in E(G)$ , let  $G - e$  denote the edge deletion minor and  $G/e$  the edge contraction minor of  $G$ .

**Lemma 5.6** *If  $G$  is IK and has a nIL simple minor, then  $\mu(G) = 5$ .*

**Proof** The proof is similar to that of the previous lemma. In particular  $\mu(G) \geq 5$ . By definition, there is an edge  $e$  such that  $G - e$  or  $G/e$  is nIL. Suppose first that  $G - e$  is nIL. By Lemma 5.2,  $\mu(G - e) \leq 4$ . We can form a graph  $G'$  homeomorphic to  $G$  by adding a degree-two vertex between  $a$  and  $b$ , the vertices of  $e$ . Then  $G'$  is a subgraph of  $K_1 * (G - e)$ , and, using Lemma 5.1,  $\mu(G') \leq 5$ . Since  $G$  is a minor of  $G'$ , by Lemma 5.1,  $\mu(G) \leq 5$ .

Next, suppose  $G/e$  is nIL, so that  $\mu(G/e) \leq 4$ . We can again recognize  $G$  as a subgraph of  $K_1 * (G/e)$ , which implies  $\mu(G) \leq 5$ . □

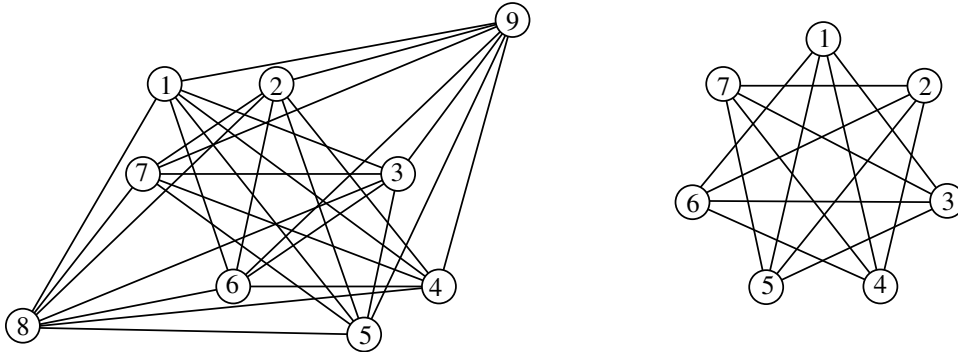

Figure 30: Left: the graph  $G_{9,28}$ . Right: the complement of a 7-cycle.

We remark that many of the known MMIK graphs have  $\mu = 6$ . In [3], the authors provide a listing of 264 MMIK graphs, of which 105 are in the families of  $K_7$ ,  $K_{3,3,1,1}$ , and  $E_9 + e$ . We will now verify that each of these three graphs has  $\mu = 6$ . By Lemma 5.3, all 105 graphs have  $\mu$ -invariant 6. As shown in [2],  $\mu(K_n) = n - 1$  when  $n > 1$ , so  $\mu(K_7) = 6$ . The graph  $K_{3,3,1,1}$  is  $K_1 * K_{3,3,1}$ . Since  $K_{3,3,1}$  is an obstruction for intrinsic linking [12], by Lemma 5.2,  $\mu(K_{3,3,1,1}) = \mu(K_{3,3,1}) + 1 \geq 6$ . On the other hand,  $K_{3,3,1,1}$  is 3-apex, which, by Lemma 5.4, shows  $\mu(K_{3,3,1,1}) \leq 6$ . Since  $E_9$  is in the  $K_7$  family, by Lemma 5.3,  $\mu(E_9) = \mu(K_7) = 6$ . By Lemma 5.1,  $\mu(E_9 + e) \geq \mu(E_9) = 6$ . On the other hand,  $E_9 + e$  is 3-apex, so, by Lemma 5.4,  $\mu(E_9 + e) \leq 6$ . By Lemma 5.3, all 110 graphs in the  $E_9 + e$  family have  $\mu = 6$  (not just the 33 that are MMIK). Note that these 110 graphs are all IK [6].

In contrast, here we have introduced several new examples of IK graphs with  $\mu = 5$ . Such examples were known previously. For example, Foisy [5] provided an example of an MMIK graph  $F$  that becomes nIL on deletion of a vertex. By Lemma 5.5,  $\mu(F) = 5$ . By Lemma 5.6,  $\mu(G_{11,35}) = 5$  as it is IK with both a nIL edge deletion minor as well as a nIL edge contraction minor. Similarly,  $\mu(G_{10,30}) = 5$  since it is IK with a nIL edge contraction minor. Finally, we argue that  $\mu(G_{10,26}) = 5$ . Since  $G_{10,26}$  is a minor of  $G_{11,35}$ , we have  $\mu(G_{10,26}) \leq \mu(G_{11,35}) = 5$ . On the other hand, as we proved in Section 3,  $G_{10,26}$  is IK, hence IL [12], and  $\mu(G_{10,26}) \geq 5$  by Lemma 5.2. By Lemma 5.3, graphs in the families of  $G_{10,26}$ ,  $G_{10,30}$ , and  $G_{11,35}$  also have  $\mu = 5$ . Using computers, the  $G_{10,26}$  family alone provides more than 600 new examples of IK graphs with Colin de Verdière invariant 5.

**Proof of Proposition 2.1** Assume there exists an IK graph  $G$  of order less than 10 which admits a nIL edge contraction minor. As such, by Lemma 5.6,  $\mu(G) = 5$ . Since  $\mu$  is minor monotone (Lemma 5.1), any MMIK minor of  $G$  must have  $\mu = 5$ . By work of Goldberg, Mattman, and Naimi [6], and Mattman, Morris, and Ryker [8], the MMIK graphs of order at most 9 are known. With the exception of  $G_{9,28}$ , depicted in Figure 30, left, all the others are either in the  $K_7$  family, the  $K_{3,3,1,1}$  family, or the  $E_9 + e$  family, and thus have  $\mu = 6$ . It follows that  $G$  must have order 9 and that  $G_{9,28}$  is a subgraph of  $G$ . If contracting an edge  $e$  of  $G$  produces a nIL minor, then deleting either endpoint of  $e$  must also produce

a nIL minor (subgraph). Since  $G_{9,28}$  is a subgraph of  $G$ , deleting the same vertex must produce a nIL subgraph of  $G_{9,28}$ . The graph  $G_{9,28}$  is highly symmetric, having a rich automorphism group, and it is structured as two nonadjacent cones over the complement of a 7-cycle (the graph depicted in Figure 30, right). Up to isomorphism, there are only two induced subgraphs of order 8 inside  $G_{9,28}$ : the graph obtained by deleting the vertex labeled 9, and the graph obtained by deleting the vertex labeled 7. Neither of these are nIL, since they both have a  $K_6$  minor. For the first graph, contracting the edges  $(4, 7)$  and  $(2, 6)$  produces a complete minor on the 6 vertices. For the second graph, contracting the edges  $(4, 9)$  and  $(2, 6)$  also produces a complete minor on the 6 vertices.  $\square$

### 6 Erratum

In this section we discuss an error in the proof of [10, Proposition 2]. The proposition asserts that if a graph  $G$  has a paneled embedding, and an edge is added to  $G$  between two vertices  $a$  and  $b$  that have a common adjacent vertex  $v$ , then  $G + ab$  has a knotless embedding.

In the proof of Proposition 2, it is first shown that one can assume there is a path  $P_{ab} \subset G$  from  $a$  to  $b$  disjoint from  $v$ . Next, the proof claims that, in any paneled embedding  $\Gamma$  of  $G$ , if  $D$  is a panel for the cycle  $P_{ab} \cup av \cup vb$  in  $\Gamma$ , then embedding the new edge  $ab$  in  $D$  yields a knotless embedding  $\Gamma'$  of  $G + ab$ . Figure 31 shows a counterexample to this claim, and will be used to explain where the error in the proof of Proposition 2 lies.

It is not difficult to see that in Figure 31, left, every cycle in  $\Gamma$  is paneled. In particular, the cycle  $acdbva$  bounds a panel  $D$  such that  $vc$  and  $vd$  lie below and above  $D$ , respectively, in the figure. If we embed the edge  $ab$  in  $D$  as in Figure 31, right, we see that the cycle  $abcvda$  is a trefoil, and hence  $\Gamma'$  isn't a knotless embedding as claimed.

The error is specifically in the last few sentences of the penultimate paragraph in the proof, where it mentions a type 1 Reidemeister move on  $P_1 \cup \{e\}$ . The proof overlooks the possibility that  $P_{bv}$  may prevent this Reidemeister move, as is the case in Figure 31, right (for reference, the paths  $acdb$ ,  $adv$ , and  $bcv$  in Figure 31 represent the paths  $P_{ab}$ ,  $P_{av}$ , and  $P_{bv}$ , respectively, in the proof of Proposition 2).

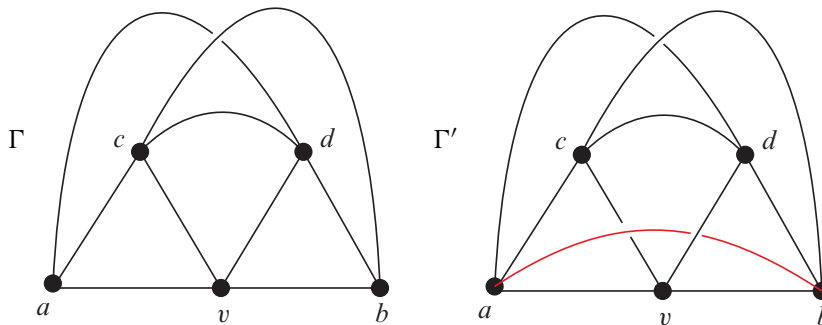

Figure 31: Left: every cycle in  $\Gamma$  is paneled. Right:  $\Gamma'$  contains a trefoil.

## Appendix

We give edge lists for the graphs  $G_{11,35}$ ,  $G_{10,30}$ , and  $G_{10,26}$ :

$E(G_{11,35})$

$$= \{(1, 2), (1, 3), (1, 4), (1, 5), (1, 8), (1, 9), (2, 3), (2, 4), (2, 8), (3, 4), (3, 5), (3, 6), \\ (3, 7), (3, 8), (3, 10), (3, 11), (4, 5), (4, 6), (4, 8), (4, 9), (4, 10), (5, 6), (5, 7), (5, 9), \\ (5, 10), (5, 11), (6, 7), (6, 8), (6, 9), (6, 10), (6, 11), (7, 11), (8, 9), (10, 11), (2, 11)\}$$

$E(G_{10,30})$

$$= \{(1, 5), (1, 7), (1, 8), (1, 9), (1, 10), (2, 3), (2, 4), (2, 5), (2, 6), (2, 7), (2, 10), (3, 4), (3, 6), (3, 8), (3, 9), \\ (3, 10), (4, 6), (4, 8), (4, 9), (5, 6), (5, 7), (5, 8), (5, 10), (6, 7), (6, 8), (6, 9), (7, 9), (7, 10), (8, 10), (9, 10)\}$$

$E(G_{10,26})$

$$= \{(1, 2), (1, 3), (1, 4), (1, 5), (1, 8), (1, 9), (2, 4), (2, 7), (2, 8), (2, 10), (3, 4), (3, 7), (3, 8), \\ (3, 10), (4, 5), (4, 6), (4, 8), (4, 9), (5, 7), (5, 9), (5, 10), (6, 7), (6, 8), (6, 9), (6, 10), (8, 9)\}$$

## References

- [1] **C C Adams**, *The knot book: an elementary introduction to the mathematical theory of knots*, Freeman, New York (1994) MR Zbl
- [2] **Y Colin de Verdière**, *Sur un nouvel invariant des graphes et un critère de planarité*, J. Combin. Theory Ser. B 50 (1990) 11–21 MR Zbl
- [3] **E Flapan, T W Mattman, B Mellor, R Naimi, R Nikkuni**, *Recent developments in spatial graph theory*, from “Knots, links, spatial graphs, and algebraic invariants” (E Flapan, A Henrich, A Kaestner, S Nelson, editors), Contemp. Math. 689, Amer. Math. Soc., Providence, RI (2017) 81–102 MR Zbl
- [4] **J Foisy**, *Intrinsically knotted graphs*, J. Graph Theory 39 (2002) 178–187 MR Zbl
- [5] **J Foisy**, *A newly recognized intrinsically knotted graph*, J. Graph Theory 43 (2003) 199–209 MR Zbl
- [6] **N Goldberg, T W Mattman, R Naimi**, *Many, many more intrinsically knotted graphs*, Algebr. Geom. Topol. 14 (2014) 1801–1823 MR Zbl
- [7] **H van der Holst, L Lovász, A Schrijver**, *The Colin de Verdière graph parameter*, from “Graph theory and combinatorial biology” (L Lovász, A Gyárfás, G Katona, A Recski, L Székely, editors), Bolyai Soc. Math. Stud. 7, Bolyai Math. Soc., Budapest (1999) 29–85 MR Zbl
- [8] **T W Mattman, C Morris, J Ryker**, *Order nine MMIK graphs*, from “Knots, links, spatial graphs, and algebraic invariants” (E Flapan, A Henrich, A Kaestner, S Nelson, editors), Contemp. Math. 689, Amer. Math. Soc., Providence, RI (2017) 103–124 MR Zbl
- [9] **R Naimi, A Pavelescu, E Pavelescu**, *New bounds on maximal linkless graphs*, Algebr. Geom. Topol. 23 (2023) 2545–2559 MR Zbl
- [10] **R Naimi, E Pavelescu, H Schwartz**, *Deleting an edge of a 3–cycle in an intrinsically knotted graph gives an intrinsically linked graph*, J. Knot Theory Ramifications 23 (2014) art. id. 1450075 MR Zbl

- [11] **R Odeneal, R Naimi, A Pavelescu, E Pavelescu**, *The complement problem for linklessly embeddable graphs*, *J. Knot Theory Ramifications* 31 (2022) art. id. 2250075 MR Zbl
- [12] **N Robertson, P D Seymour, R Thomas**, *Linkless embeddings of graphs in 3-space*, *Bull. Amer. Math. Soc.* 28 (1993) 84–89 MR Zbl
- [13] **H Sachs**, *On spatial representations of finite graphs*, from “Finite and infinite sets, II” (A Hajnal, L Lovász, V T Sós, editors), *Colloq. Math. Soc. János Bolyai* 37, North-Holland, Amsterdam (1984) 649–662 MR Zbl
- [14] **K Taniyama, A Yasuhara**, *Realization of knots and links in a spatial graph*, *Topology Appl.* 112 (2001) 87–109 MR Zbl

*Department of Mathematics and Statistics, California State University at Chico  
Chico, CA, United States*

*Department of Mathematics, Occidental College  
Los Angeles, CA, United States*

*Mathematics and Statistics Department, University of South Alabama  
Mobile, AL, United States*

*Mathematics and Statistics Department, University of South Alabama  
Mobile, AL, United States*

`tmattman@csuchico.edu`, `rnaimi@oxy.edu`, `andreipavelescu@southalabama.edu`,  
`elenapavelescu@southalabama.edu`

<http://tmattman.yourweb.csuchico.edu>, <http://faculty.oxy.edu/rnaimi/>,  
<http://apaveles.wixsite.com/scientist-site>

Received: 18 May 2022





# ALGEBRAIC & GEOMETRIC TOPOLOGY

msp.org/agt

## EDITORS

### PRINCIPAL ACADEMIC EDITORS

John Etnyre  
etnyre@math.gatech.edu  
Georgia Institute of Technology

Kathryn Hess  
kathryn.hess@epfl.ch  
École Polytechnique Fédérale de Lausanne

### BOARD OF EDITORS

Julie Bergner	University of Virginia jeb2md@eservices.virginia.edu	Robert Lipshitz	University of Oregon lipshitz@uoregon.edu
Steven Boyer	Université du Québec à Montréal cohf@math.rochester.edu	Norihiko Minami	Nagoya Institute of Technology nori@nitech.ac.jp
Tara E Brendle	University of Glasgow tara.brendle@glasgow.ac.uk	Andrés Navas	Universidad de Santiago de Chile andres.navas@usach.cl
Indira Chatterji	CNRS & Univ. Côte d'Azur (Nice) indira.chatterji@math.cnrs.fr	Thomas Nikolaus	University of Münster nikolaus@uni-muenster.de
Alexander Dranishnikov	University of Florida dranish@math.ufl.edu	Robert Oliver	Université Paris 13 bobol@math.univ-paris13.fr
Tobias Ekholm	Uppsala University, Sweden tobias.ekholm@math.uu.se	Jessica S Purcell	Monash University jessica.purcell@monash.edu
Mario Eudave-Muñoz	Univ. Nacional Autónoma de México mario@matem.unam.mx	Birgit Richter	Universität Hamburg birgit.richter@uni-hamburg.de
David Futer	Temple University dfuter@temple.edu	Jérôme Scherer	École Polytech. Féd. de Lausanne jerome.scherer@epfl.ch
John Greenlees	University of Warwick john.greenlees@warwick.ac.uk	Vesna Stojanoska	Univ. of Illinois at Urbana-Champaign vesna@illinois.edu
Ian Hambleton	McMaster University ian@math.mcmaster.ca	Zoltán Szabó	Princeton University szabo@math.princeton.edu
Matthew Hedden	Michigan State University mhedden@math.msu.edu	Maggy Tomova	University of Iowa maggy-tomova@uiowa.edu
Hans-Werner Henn	Université Louis Pasteur henn@math.u-strasbg.fr	Nathalie Wahl	University of Copenhagen wahl@math.ku.dk
Daniel Isaksen	Wayne State University isaksen@math.wayne.edu	Chris Wendl	Humboldt-Universität zu Berlin wendl@math.hu-berlin.de
Thomas Koberda	University of Virginia thomas.koberda@virginia.edu	Daniel T Wise	McGill University, Canada daniel.wise@mcgill.ca
Christine Lescop	Université Joseph Fourier lescop@ujf-grenoble.fr		

---

See inside back cover or [msp.org/agt](https://msp.org/agt) for submission instructions.

The subscription price for 2024 is US \$705/year for the electronic version, and \$1040/year (+\$70, if shipping outside the US) for print and electronic. Subscriptions, requests for back issues and changes of subscriber address should be sent to MSP. Algebraic & Geometric Topology is indexed by Mathematical Reviews, Zentralblatt MATH, Current Mathematical Publications and the Science Citation Index.

Algebraic & Geometric Topology (ISSN 1472-2747 printed, 1472-2739 electronic) is published 9 times per year and continuously online, by Mathematical Sciences Publishers, c/o Department of Mathematics, University of California, 798 Evans Hall #3840, Berkeley, CA 94720-3840. Periodical rate postage paid at Oakland, CA 94615-9651, and additional mailing offices. POSTMASTER: send address changes to Mathematical Sciences Publishers, c/o Department of Mathematics, University of California, 798 Evans Hall #3840, Berkeley, CA 94720-3840.

---

AGT peer review and production are managed by EditFlow<sup>®</sup> from MSP.

PUBLISHED BY

 **mathematical sciences publishers**  
nonprofit scientific publishing

<https://msp.org/>

© 2024 Mathematical Sciences Publishers

# ALGEBRAIC & GEOMETRIC TOPOLOGY

Volume 24 Issue 2 (pages 595–1223) 2024

---

Comparing combinatorial models of moduli space and their compactifications	595
DANIELA EGAS SANTANDER and ALEXANDER KUPERS	
Towards a higher-dimensional construction of stable/unstable Lagrangian laminations	655
SANGJIN LEE	
A strong Haken theorem	717
MARTIN SCHARLEMANN	
Right-angled Artin subgroups of right-angled Coxeter and Artin groups	755
PALLAVI DANI and IVAN LEVCOVITZ	
Filling braided links with trisected surfaces	803
JEFFREY MEIER	
Equivariantly slicing strongly negative amphichiral knots	897
KEEGAN BOYLE and AHMAD ISSA	
Computing the Morava $K$ -theory of real Grassmannians using chromatic fixed point theory	919
NICHOLAS J KUHN and CHRISTOPHER J R LLOYD	
Slope gap distributions of Veech surfaces	951
LUIS KUMANDURI, ANTHONY SANCHEZ and JANE WANG	
Embedding calculus for surfaces	981
MANUEL KRANNICH and ALEXANDER KUPERS	
Victoris–Rips persistent homology, injective metric spaces, and the filling radius	1019
SUNHYUK LIM, FACUNDO MÉMOLI and OSMAN BERAT OKUTAN	
Slopes and concordance of links	1101
ALEX DEGTYAREV, VINCENT FLORENS and ANA G LECUONA	
Cohomological and geometric invariants of simple complexes of groups	1121
NANSEN PETROSYAN and TOMASZ PRYTUŁA	
On the decategorification of some higher actions in Heegaard Floer homology	1157
ANDREW MANION	
A simplicial version of the 2–dimensional Fulton–MacPherson operad	1183
NATHANIEL BOTTMAN	
Intrinsically knotted graphs with linklessly embeddable simple minors	1203
THOMAS W MATTMAN, RAMIN NAIMI, ANDREI PAVELESCU and ELENA PAVELESCU	