

THE JOURNAL OF THE ANTI-SEISMIC SYSTEMS INTERNATIONAL SOCIETY (ASSISI)

Seismic Isolation and Protection Systems

SEISMIC ISOLATION OF LIQUEFIED NATURAL GAS TANKS:
A COMPARATIVE ASSESSMENT

Joaquín Martí, María Crespo and Francisco Martínez

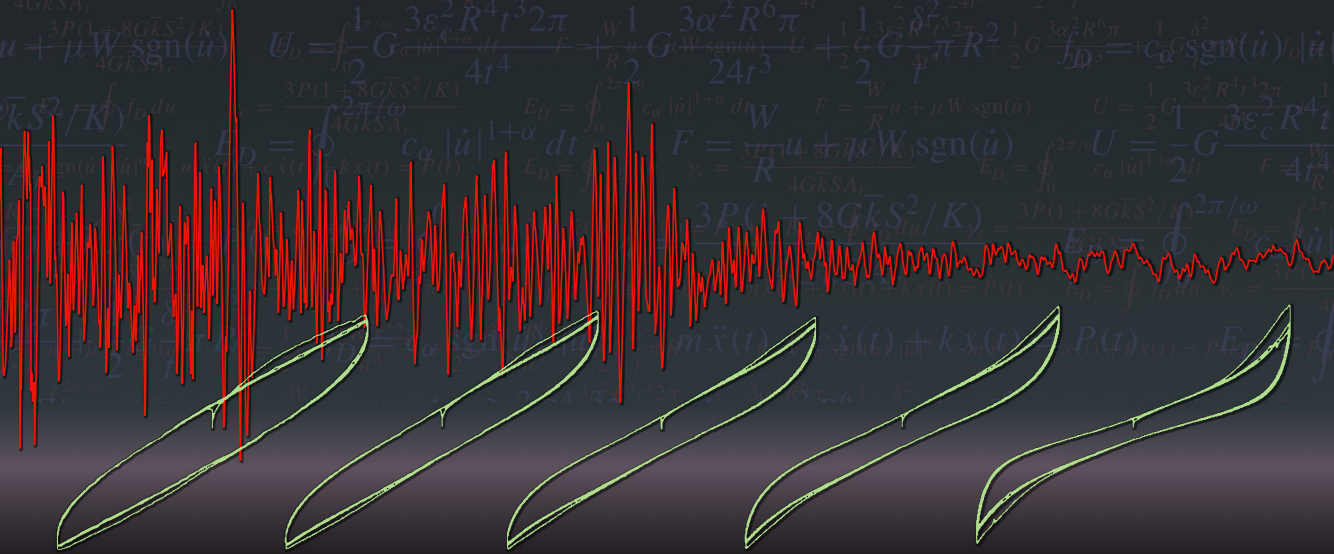

vol 1, no 1

2010

SEISMIC ISOLATION OF LIQUEFIED NATURAL GAS TANKS: A COMPARATIVE ASSESSMENT

JOAQUÍN MARTÍ, MARÍA CRESPO AND FRANCISCO MARTÍNEZ

In severe seismic environments, tanks for storage of liquefied natural gas may benefit from seismic isolation. As the design accelerations increase, the inner tank undergoes progressively greater demands and may suffer from corner uplift, elephant's foot buckling, gross sliding, shell thickness requirements beyond what can be reliably welded and, eventually, global uplift. Some of these problems cause extra costs while others make the construction impossible. The seismic environments at which the previous problems arise are quantified for modern 160,000 m³ tanks, whether supported on shallow or pile foundations, for both a conventional design and one employing seismic isolation. Additionally, by introducing some cost assumptions, comparisons can be made as to the cost of dealing with the seismic threat for each seismic environment and tank design option. It then becomes possible to establish the seismic environments that require seismic isolation, as well as to offer guidance for decisions in intermediate cases.

1. Introduction

Earthquakes contribute significant demands to the design of structures in many parts of the world. These demands can be dealt with in a conventional fashion or, alternatively, seismic isolation may also be provided to lessen their impact. The object of seismic isolation is to decrease the stresses and other demands that the earthquakes cause on the structure, even if this might entail other less desirable side effects such as increased relative displacements. The present paper attempts to clarify the advantages and disadvantages of the seismic isolation strategy in relation with storage tanks for liquefied natural gas (LNG).

Natural gas is primarily made of methane, which in gas form has a very small density. For moderate distances overland, gas-lines can be used to transport the gas efficiently. However for transport over very large distances or across oceans, the only alternative is to ship it in gas tankers in liquid form, which increases its density by a factor of about 600. At atmospheric pressures this implies operating at temperatures on the region of -166°C . To allow reasonably fast and predictable loading and unloading of the gas tankers, storage tanks must be provided; at export terminals they store the LNG produced in the liquefaction plant pending its transfer to the tanker, while at import terminals they receive and store the cargo that the vaporization plant will then process gradually.

Currently the more extended type of storage tank is the above-ground, full containment tank; the latter means that it provides containment for both liquid and vapor at operating temperatures. Underground tanks also exist but they are more expensive and cumbersome to build and, with the exception of Japan where the regulations often require them, they are considerably less common. Modern above-ground

Keywords: seismic isolation, LNG tank.

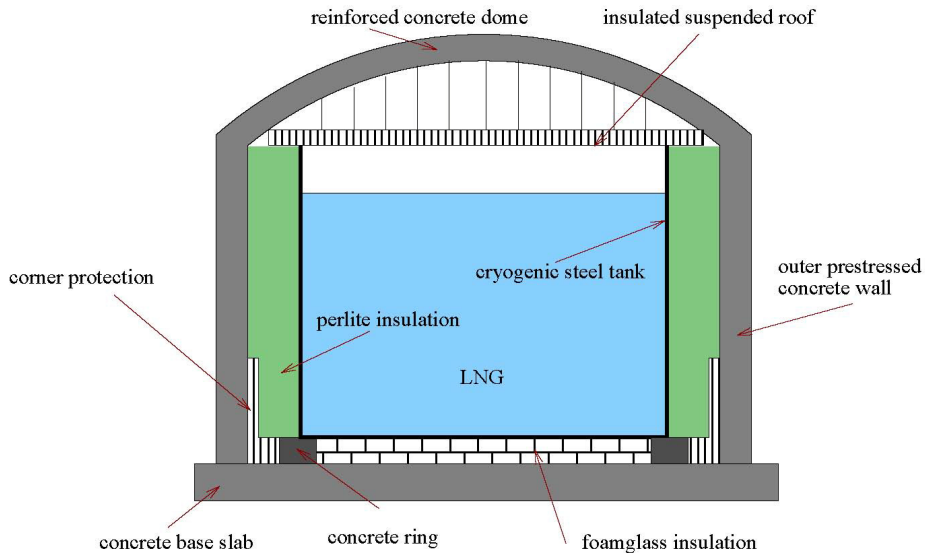

Figure 1. Schematic view of a modern LNG tank.

tanks typically have a storage capacity of around $150,000 \text{ m}^3$, which is also consistent with the capabilities of the modern fleet.

A full containment tank is composed of an inner, self-standing, steel tank and an outer concrete tank. The inner tank is cylindrical and open at the top; it is made of cryogenic steel (9% Ni) in order to ensure adequate ductility at the operating temperatures and rests on thermal insulation placed on the base slab of the outer tank. The outer tank is made of concrete. The cylindrical wall is post-tensioned, both in the vertical and hoop directions. The base slab and the spherical dome consist of simply reinforced concrete. Adequate thermal insulation is provided between the two tanks. In the more common case in which the base slab is in direct contact with the ground, electrical heating is provided inside the slab in order to keep the ground from freezing, which would lead to unacceptable volume changes in the foundation.

With relatively minor variations, the global dimensions of modern LNG tanks tend to be 80 m for the diameter and 40 m for the wall height, with a peripheral space of 1 m between the two tanks. The dome radius is normally equal to the tank diameter, which means that the dome slopes 30° at the periphery. The wall thickness is usually 80 cm and the minimum dome thickness is 40 cm. [Figure 1](#) shows a schematic view of the overall arrangement.

2. Seismic concerns in the design

LNG tanks are considered to be high responsibility structures due to the chemical energy that they store. As a consequence, their design requirements [[API 2004](#); [BSI 1993](#); [CEN 2006](#); [CEN 2007](#); [NFPA 2006](#)] are fairly stringent. From the viewpoint of seismic demands, they take into account an Operating Basis Earthquake (OBE) with a return period of 475 years and a Safe Shutdown Earthquake (SSE) with a return period on the region of 2500 to 5000 years, depending on the specific standard being used. They also include many other requirements and postulated accidents.

The design must finally satisfy all of the requirements imposed. However, seismic considerations govern only certain specific aspects of the design, their implications obviously growing as the design motions increase. But for many of the tanks' characteristics, the design is largely unaffected by the seismic specifications.

The design of the outer tank is seldom governed by earthquake considerations. This is because, being the outer protective skin, it must be sufficiently robust to withstand all other threats from outside the tank and even some from inside. The design events include low probability winds, impacts from flying missiles, overpressures from a hydrocarbon cloud deflagration, etc. But the two more demanding ones are the major leak and the external fire. In the former the liquid gas is postulated to escape from the inner tank, fill the annular space and apply its hydrostatic pressures and low temperatures directly to the concrete; in the latter the tank is subjected to high thermal fluxes for certain periods of time. As a consequence, except for perhaps having to add a small amount of reinforcement in the dome, the design of the outer tank is barely affected by the specified seismic motions.

The inner tank though, protected as it is from most external events by the outer tank, is only designed to contain the liquid gas. It is therefore much more sensitive to seismic effects, which are practically the only demands beyond operating conditions for which the outer tank provides little protection.

An increase in the input motions leads to larger seismically generated stresses, liquid pressures, forces and displacements. In principle, this type of consequences can be handled simply by increasing material quantities; in this case the seismic effects on quantities and costs are gradual, growing with the size of the design motions. However, there are some thresholds beyond which the strengthening process cannot be pursued continuously; at those points, either a new feature must be incorporated to the design or, in some cases, the construction of the tank becomes impossible.

One of the consequences of the earthquake is sloshing, the generation of standing waves in the free surface of the liquid. The predicted wave height must be incorporated as additional freeboard of the inner tank in order to prevent spills. This increases the height requirements of both inner and outer tanks, with considerable financial consequences. However, the typical sloshing periods are very long (about 10 s); and although the periods of nonisolated and isolated tanks differ substantially (about 0.5 s and perhaps 2–3 s, respectively), they are so far removed from the sloshing period that the wave height is generally not affected by seismic isolation. In short, sloshing implies an increase in costs but, the increase being similar for isolated and nonisolated tanks, it does not lead to a differential advantage.

Apart from sloshing, which involves the so-called convective liquid mass, the movements of the rest of the liquid mass, the impulsive mass, entail important pressure variations in the liquid. The same occurs with the vertical ground movements, which also excite the liquid mass. All of them imply departures from the preexisting hydrostatic pressures, which the inner tank must be able to deal with.

Additionally rocking excitations may lead to excessive compression of the tank wall (producing the elephant's foot buckling) and/or lift-off at the opposite corner of the tank; anchor straps may provide some help in respect of the latter problems, although that strategy is not totally free of uncertainties and disadvantages: undesirable thermal bridges across the insulation, stress concentrations in the shell, a protracted construction schedule and even some uncertainties in the seismic response; these aspects will be discussed later in more detail. The problems linked to rocking are of course alleviated by a flatter aspect ratio of the tank, though this strategy has adverse implications on space occupancy.

Another undesirable response of the inner tank would be gross sliding. The inner tank rests on a thin leveling layer of sand, placed above the thermal insulation. The horizontal demands, coupled with a dynamically decreased vertical weight, may lead to gross sliding of the inner tank. There is little that the designer can do to avoid this problem if it does tend to occur, even a flatter aspect ratio would not improve the situation.

Finally, if the vertical accelerations were sufficiently high, the upward vertical forces might exceed the static weight, whereupon the inner tank and the liquid would lift off globally. Again, no practical solution exists for this problem.

In summary, for the present evaluation of the possible contribution of seismic isolation, the following problems, as developed by a gradually increasing seismic input, will be taken into account together with their solutions when they are feasible:

- Larger liquid pressures and increased compression of the wall. The traditional solution is to use a thicker shell and/or provide additional stiffening.
- Corner uplift. When expected, a common solution strategy is to anchor the inner tank in spite of the possible disadvantages already mentioned.
- Gross sliding of the tank. This problem has no known solution, even changing the aspect ratio of the tank will not resolve it.
- Required thickness of inner tank exceeds about 50 mm. The thickness of cryogenic steel that can be reliably welded is limited; the specific limit may be arguable to some extent, here it will be assumed to be 50 mm.
- Global uplift of the tank. Again, when this is expected, no practical solution is known.

The first two items above are not fatal, in the sense that they simply require additional expenditure. The last three, however, have no known solution in current practice; hence, when those thresholds are reached, the tank can no longer be built according to the current standards.

Analyses will be conducted here to compare how the additional costs evolve with increasing seismic demands, depending on whether seismic isolation is used or not; both shallow and pile foundations will be considered, as this aspect has important implications on the results. The calculations will also allow determining when the construction of the tank ceases to be feasible with each design strategy.

3. Seismic isolation

Seismic isolation is a wide field. The reader is referred to [Skinner et al. 1993; Naeim and Kelly 1999] for a general review of the subject. The seismic isolation of liquid storage tanks has received some attention in recent years. Some examples are provided in [Tajirian 1998; Wang et al. 2001; Shrimali and Jangid 2002; 2004; Cho et al. 2004]. Numerical techniques have also been developed in order to treat the complexity of the seismic response of isolated tanks, as in [Wang et al. 2001; Kim et al. 2002; Cho et al. 2004]. However, LNG tanks pose their own specific requirements, which arise mainly from the cryogenic temperatures at which they operate and from the potentially serious consequences of any accidental releases.

The fast growth of the gas market worldwide over the last couple of decades, in both stable and earthquake prone regions, has led to research and applications of seismic isolation for LNG storage

tanks. Malhotra [1997; 1998] has proposed some novel isolation ideas which, at least for LNG tanks, would be rather difficult to implement in practice. The majority of the studies carried out concentrate their attention either in high damping rubber bearings (HDRBs), with or without a lead core, and in friction pendulum systems (FPSs). Some recent accounts have been provided by [Tajirian 1998; Böhler and Baumann 1999; Kim et al. 2002; Rötzer et al. 2005; Gregoriou et al. 2006; Manabe and Sakurai 2007; Christovasilis and Whittaker 2008]. Also relatively recently, Project INDEPTH, financed by the European Union over the period 2003-6, contributed considerable research on this topic [Crespo et al. 2006; Bergamo et al. 2007]; indeed the present paper uses some results from that project.

From the viewpoint of practical implementations, the authors are aware that seismic isolation has been provided at LNG tanks in the following sites: Revithoussa in Greece (2 tanks), Inchon in South Korea (3 tanks), Pyeong-Taek again in South Korea (10 tanks), Aliaga in Turkey (2 tanks) and Guangdong in China (2 tanks); the Manzanillo tanks in Mexico, currently under construction, are also expected to rest on seismic isolators. The Greek tanks are exceptional in that they are rather small (their capacity is only 65,000 m³ per tank), located below ground, and use a friction pendulum system for isolation. The rest of the tanks are larger (100,000 m³ to 150,000 m³ per tank), located above the ground surface and relying on elastomeric bearings, with or without a lead core for providing the required damping.

It is clear that the use of seismic isolation can decrease the seismic demands developed in the tank structure. Its beneficial action can be exerted in two ways. The first horizontal frequencies of the tank are about 2 Hz for the inner tank full of LNG and about 5–7 Hz for the outer tank; this frequency range corresponds to the plateau region in practically all design spectra, as can be seen in the spectra shown in the next section. Consequently a first line of action is that if the isolation were to lower those frequencies, this would immediately entail a decrease of the seismic demands. In essence, reducing the stiffness that opposes the horizontal displacements of the base of the structure introduces a first mode in which the overall tank moves, with the distortions mainly developing in the isolation system, thereby minimizing the internal distortions of the tank. Of course a second way in which the isolation can be beneficial is by dissipating energy in the case of systems that have this capability.

The reduction of the spectral accelerations caused by a shift in the resonant frequency does have some deleterious effects though, namely an increase in the relative displacements between the ground and the tank. It should be remembered that about 20 lines go from the ground to the tank; they escalate the wall and enter the tank through penetrations located in the dome. The lines include large diameter pipes for loading and unloading the LNG, but also nitrogen, water and many other service pipes, as well as power cables, instrumentation, etc. All of them must be provided with flexible connections, able to accommodate the dynamic evolution of the relative displacements during the earthquake, which will be particularly large in the two horizontal directions. The cost of the necessary flexible connections, that must prevent leakage from large diameter pipes operating at high pressures and cryogenic temperatures, may be considerable.

It is worth highlighting that a seismic isolation system for an LNG tank essentially must limit its scope to acting in the horizontal direction. The vertical stiffness has to remain high in all cases and the supporting surface of the inner tank cannot depart much from a horizontal plane. Indeed, norms such as BS 7777 or the newer EN 14620 limit the differential settlements, even under the hydraulic test in which the tank is filled with water to reach 1.25 times the operating weight of LNG. The limitation stems from the sensitivity of the inner tank to the distortions caused by differential settlements, a sensitivity that is

easily understood when considering that the upper part of the inner tank wall has a shell thickness of only 10–12 mm and a diameter of some 80 m.

Hence, although seismic isolation provides help in the horizontal direction, practically nothing can be done in the vertical one. Thus the traditionally smaller role of the vertical demands becomes proportionally much more important in seismically isolated tanks and may even govern parts of the design.

When considering vertical effects, there is one aspect that is often disregarded. For horizontal motions, the decomposition of the liquid mass into its impulsive and convective components is perfectly standard [ASCE 1984; Veletsos and Tang 1990], but for vertical motions the liquid is normally considered to act as a rigid mass that moves with the base slab. In many situations this assumption becomes insufficient and a decomposition of the liquid mass must also be incorporated for the vertical motions [Veletsos and Tang 1986]. When this is done, only part of the liquid mass moves rigidly with the slab; the rest oscillates with the frequency of the first breathing mode of the inner tank, which is typically around 2 Hz.

No attempt will be made here to compare different seismic isolation strategies. As mentioned earlier, all implementations of seismic isolation in LNG tanks to date, with the exception of the smaller Revithoussa tanks, have used elastomeric bearings. This will be the system adopted here; it will also be assumed that the design of the seismic isolators is carried out to comply with the AASHTO Guidelines [AASHTO 2000]. The vertical stiffness of the tank support is assumed to remain unaffected by the isolation; in the horizontal direction the characteristics of the isolation are such that the first horizontal frequency of the tank is 0.4 Hz with 15% damping. The displacement requirements imposed on the isolators will of course be a function of the level of the design motions.

4. Implications of the seismic loads

The seismic input has been defined here by means of two features: a spectral shape and a reference acceleration used for scaling the previous spectral shape. For the spectral shape, three different ones have been considered, one corresponding to a medium type spectrum and two which are enriched either in the low or in the high frequency range of the spectrum. More specifically, the three spectral shapes adopted are those that Eurocode 8 [CEN 2004] recommends for soil types B, C and D and type 1 earthquakes (magnitude $M_s > 5.5$). The normalized spectra are shown in Figure 2; these spectra should be multiplied

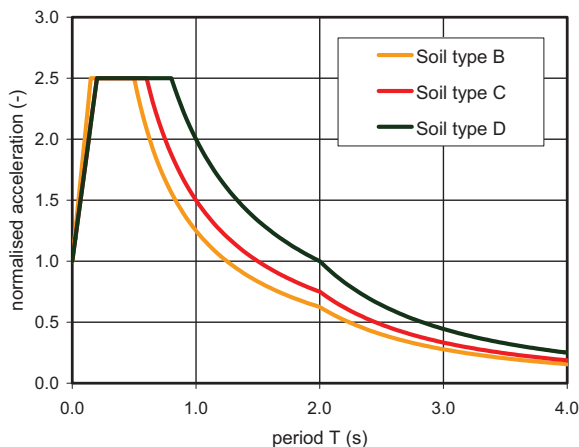

Figure 2. Spectral shapes used in the calculations.

by the Zero Period Acceleration (ZPA), $a_g S$ using EC8 terminology, which includes the influence of the soil through the soil factor S . For vertical motions, the spectral shapes have been obtained by multiplying the previous ones by 0.7.

The reference acceleration a_g will be taken as a continuously varying parameter, descriptive of the hazard level at the site. For a given spectral shape, this will allow studying the acceleration levels that trigger the various events. Incidentally, simply looking at the figure, the advantages of using seismic isolation for moving the first frequencies from their normal values (around 2 Hz for the inner tank and some 5–7 Hz for the outer tank) to somewhere in the 0.3–0.5 Hz range are immediately obvious.

The nonisolated tank with a shallow foundation is assumed to rest directly on reasonably competent ground; otherwise it would not have been able to fulfill the requirements that [BSI 1993] imposes on differential settlements. Specifically, a soil with an effective shear modulus of 180 MPa and a density of 2000 kg/m³ is assumed, resulting the shear wave velocity of 300 m/s. Classical formulae for the calculation of the horizontal, vertical and rocking stiffnesses have been used [ASCE 2000]. In the case of a tank supported on piles, the foundation has been assumed to consist of 300 concrete piles, each 1.5 m in diameter and 40 m long. The global horizontal and vertical stiffnesses calculated for this foundation are nearly 4 times those of the shallow foundation, while for the rocking stiffness the factor is approximately 1.5.

From the viewpoint of the material properties of the structure, only the properties of the inner tank have an influence on the results. For the 9% Ni steel, it is assumed that the Young's modulus is 200 GPa, the Poisson's ratio is 0.3 and the density is 7850 kg/m³.

Since a cost comparison is being sought, this requires information on unit costs which contractors are loath to disseminate. The assumptions given below should only be considered reasonable approximations, with a certain range of uncertainty. Nevertheless, the final conclusions are thought to be fairly robust and, apart from perhaps some minor variations, they should stand in spite of the shortcomings of the unit costs employed. The specific assumptions follow.

As mentioned earlier the AASHTO Guidelines were used to design the elastomeric seismic isolation. It should be noticed that costs may be strongly affected by the code used: for example a design following the Italian seismic code will result in higher costs, while the Japanese code will probably lead to lower ones. The cost of the isolation system is a strong function of the design relative displacements, increasing from 1.2 M€ for 20 cm to about 4.5 M€ for 60 cm displacement.

The relative movement between the various structures and the ground allowed by the seismic isolation requires providing the piping with connections that maintain their function in spite of those relative movements. For a typical LNG tank the cost of the flexible connections has been estimated as 0.3 M€.

Unit costs for different types of concrete structures are needed. Concrete placed on the ground has been assumed to cost 300 €/m³, a figure that increases to 450 €/m³ for concrete placed at an elevation that requires formwork and structural supports.

If the local geotechnical conditions are such that if the tank requires a pile foundation, the placement of seismic isolators does not entail the need for any additional concrete, one device would be placed in each pile, more or less directly under the base slab of the tank. However, if a surface slab suffices, the placement of isolation devices requires constructing a double mat and concrete pedestals between the two slabs, with the devices placed in the upper part of the pedestals. It has been assumed that, except for its periphery, a shallow slab is only 0.7 m thick, while in the case of a double slab a thickness of 1 m

is required for both slabs; pedestals are constructed every 12 m² of slab and they are assumed to be 2 m high and 1 m in diameter.

As the seismic demand increases, the walls of the steel tank may need to be thicker and there is also the possibility that steel anchors are needed. The required steel thickness is a function of the expected pressures in the liquid, which are of course affected by the earthquake. The steel needed for both, container and anchors, is cryogenic, adequate for withstanding the low operating temperatures. A unit cost of 5 €/kg has been used here.

Anchorage is not required with the usual aspect ratios of tanks until the PGA reaches about 0.3 g. When required, the minimum cost of anchorage has been taken as 0.35 M€, increasing with the amount of steel required by the anchor system.

When the base slab is placed directly on the ground, the slab must be heated to keep the ground from freezing underneath. If the base slab is elevated and air circulates freely below, then heating is no longer necessary. This arrangement, however, is only possible when there is a double slab or, in the case of pile foundations, if the piles are extended some 2 m above the ground surface before building the slab. The total cost of the installed heating system may be on the region of 1 M€. The energy costs are harder to include because, over the life of the tank, their effect may be strongly affected by variables like inflation rates, interest rates and electricity costs. Here the energy savings have been taken as equivalent to the upfront saving of 10 years of energy consumption, with a unit cost of 0.1 €/kWh. The energy savings for a 160,000 m³ tank can then be estimated at 1 M€.

5. Calculation of seismic response

As mentioned earlier, some of the calculations were initiated within the framework of the EC-funded IN-DEPTH project and useful information has also been incorporated based on the publications of [Bergamo et al. 2006a; Bergamo et al. 2006b; Castellano et al. 2006] and [Gregoriou et al. 2006].

The specific dimensions used for the tank are as follows:

Inner tank:	diameter	78.00 m	Spherical roof:	internal radius	80.00 m
				thickness	0.40 m
Outer tank wall:	internal diameter	80.00 m			
	height	40.15 m	Slab:	diameter	81.60 m
	thickness	0.80 m		thickness	1.0 m

The height and the thicknesses of the inner tank depend on the level of acceleration, so no specific values are indicated above.

The calculations performed involve the response of an isolated tank and that of a nonisolated tank for progressively increasing levels of the response spectra presented earlier. As already mentioned, the isolated tank is assumed to be supported on devices that are vertically rigid and take the first horizontal period of the tank to 2.5 s with 15% damping. For both tanks, the following tasks are carried out:

- Determination of the liquid masses (impulsive and convective), mobilized in relation with the horizontal response of the tank, on the assumption of a full inner tank.
- Determination of the liquid masses (responding rigidly and in the first breathing mode), mobilized in relation with the vertical response of the tank, on the assumption of a full inner tank.

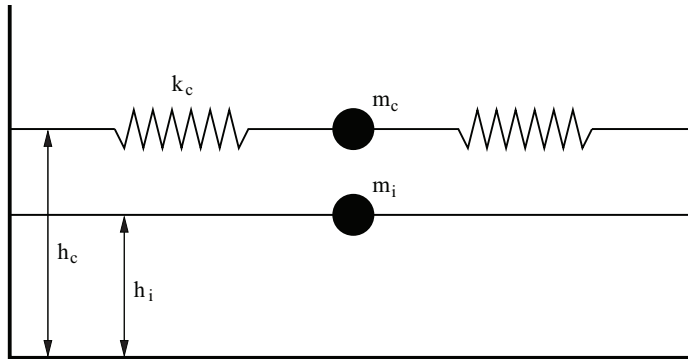

Figure 3. Effective liquid masses in horizontal oscillations.

- Determination of the lower natural frequencies of the inner tank, for both horizontal and vertical excitation.
- Use of the response spectrum method, with suitable combinations of the horizontal and vertical components, in order to determine the need for increasing material quantities, as well as the points beyond which the design is no longer possible.

The calculations follow the methodology proposed by the ASCE Standard 4-98 [ASCE 2000] and the Guidelines for the Seismic Design of Oil and Gas Pipeline Systems [ASCE 1984]. For the vertical excitation this methodology is supplemented with that proposed by [Veletsos and Tang 1986]. Under horizontal excitation the impulsive mass, which moves rigidly attached to the inner tank and hence oscillates at 2.08 Hz, turns out to be 48% of the total; the remaining 52% is the convective mass, with a first sloshing frequency of 0.104 Hz. The situation can be visualized in Figure 3. For vertical oscillations, the rigid mass, which follows the motion of the tank's base, represents 42% of the total mass; the remaining 58% of the liquid mass vibrates in the first breathing mode at 2.08 Hz (its precise similarity with the horizontal frequency is a mere coincidence). As an example, Figure 4 shows a finite element

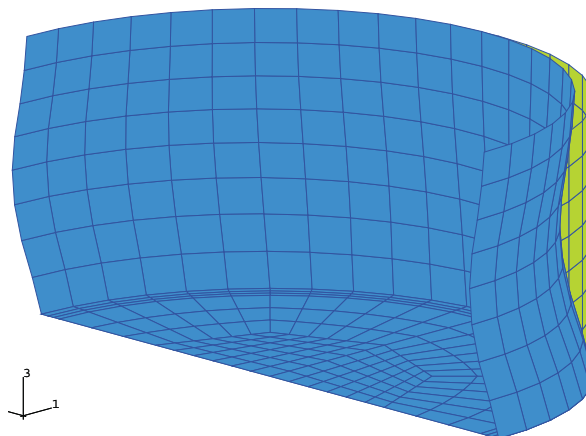

Figure 4. First horizontal mode of the full inner tank.

model of an LNG tank; the deformed shape corresponds to the first horizontal mode of the full inner tank on the assumption of a rigid foundation.

It is important to note that the effects arising from the various liquid masses have to be combined by direct addition. By contrast the effects of the different components of the earthquake have been combined assuming 100% of the horizontal component with 30% of the vertical one, and vice versa. Finally, the structural effects associated with different modes of the tank have been combined with the SRSS rule.

An important contribution to the cost may arise from the need of additional cryogenic steel for the inner tank. The thickness at the various elevations must suffice for dealing with three demands: *hydrostatic conditions*, *OBE conditions*, and *SSE conditions*.

It is seldom obvious which of the latter two cases is more limiting, even though the SSE is clearly greater than the OBE, because standards use different evaluation rules and different values of the allowable steel stresses for OBE and SSE conditions. In the calculation of the inner tank, both the horizontal and vertical excitations have to be considered and combined as described above.

Finally, the calculations of corner uplift have been conducted following the methodology described in API 620 [API 2004].

The following milestones are determined by the calculations for the spectrum corresponding to soil type C. The ranges describe the effect of the different foundations used in the analyses (piles and surface slab):

- (a) For nonisolated tanks, when the peak ground acceleration (PGA) reaches
 - 0.25 g–0.30 g: there is corner uplift unless anchorage is provided.
 - 0.50 g–0.65 g: the inner tank starts to slide during the earthquake.
 - ~ 1.00 g: there is global uplift of the inner tank.
- (b) For isolated tanks, when the peak ground acceleration (PGA) reaches
 - 0.80 g–0.90 g: the inner tank starts to slide during the earthquake.
 - ~ 1.00 g: there is global uplift of the inner tank.

Although the isolation does not affect the response of the tank to vertical excitations, the accelerations that produce global uplift actually turn out to be slightly higher for the nonisolated case, but this is a consequence of the thinner shell thickness required in the isolated case.

Equivalent results have also been obtained for the other two spectra (soil types B and D). For nonisolated tanks, corner uplift appears for the same range of accelerations for soil types C and D; however, for soil type B, this effect appears at an acceleration about 30% higher. Global sliding is more sensitive to the type of spectrum: the triggering acceleration for soil type C is about 20% higher than for soil type D, and is also 20% higher for soil type B than for soil type C. Finally, the accelerations at which global uplift appears have a smaller range of variation, between 5 and 10%.

For isolated tanks, the sensitivity to the type of spectrum is generally lower: the accelerations triggering global sliding vary between 5 and 10% with the type of spectrum; the accelerations that cause global uplift have a very small range of variation, below 5%.

As a function of the peak ground acceleration, based on the previous results for soil type C, the following statements can be made regarding the feasibility of the design:

- Up to 0.25 g–0.30 g: both isolated and nonisolated tanks are possible without anchorage

- From 0.25 g–0.30 g to 0.50 g–0.65 g: an isolated tank is still possible without anchorage, but a nonisolated tank requires anchorage.
- From 0.50 g–0.65 g to 0.80 g–0.90 g: only an isolated tank is possible, which can still be unanchored.
- From about 0.8 g–0.90 g onwards: no tanks can be built using current standards and methodology, since even an isolated tank will undergo gross sliding during the earthquake.

The comments made earlier in relation with the influence of the soil type and its associated spectral shape are also applicable in relation with the figures given above.

6. Differential costs

By combining the structural and cost information, it becomes possible to compare the different situations and design strategies. Three cases will be shown:

- a conventional design, without seismic isolation, whether supported on a surface slab or on piles;
- a seismically isolated tank, which already required a pile foundation in any case and has an isolating device per pile;
- a seismically isolated tank, which did not require a pile foundation for other reasons and therefore had to be provided with a double slab and pedestals for placing the devices.

The only costs considered are those incurred as a consequence of the seismic demands and only if they vary between the three cases. For example, a larger earthquake implies greater sloshing waves and hence an increased height of the inner and outer tanks, but this cost will not be taken into account because it is identical in all cases. The curves presented are therefore useful only for establishing cost differences between the various strategies, since the absolute values do not reflect the common costs. More specifically, the following costs are included:

For the nonisolated tank:

- increased thickness of inner tank
- anchorage of inner tank

For the isolated tank on piles:

- isolation system
- flexible pipe connections
- increased thickness of inner tank
- anchorage of inner tank

For the isolated tank on a surface slab:

- dual slab and pedestals
- savings in heating system and energy
- isolation system
- flexible pipe connections
- increased thickness of inner tank
- anchorage of inner tank

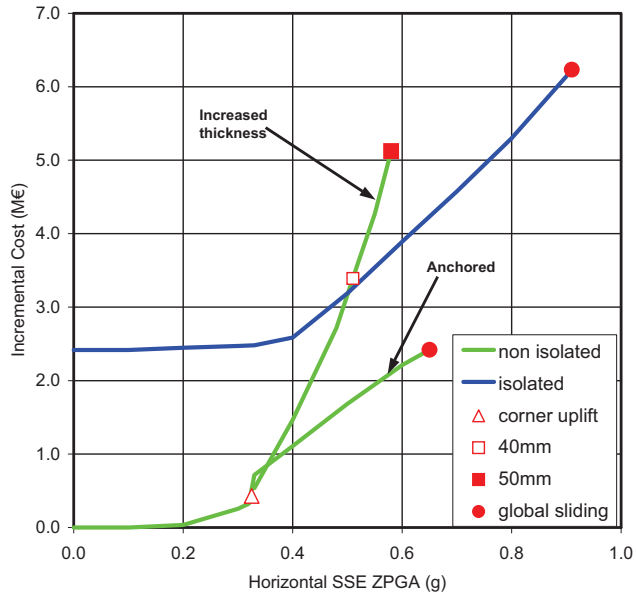

Figure 5. Cost evolution with seismic demand: slab foundation.

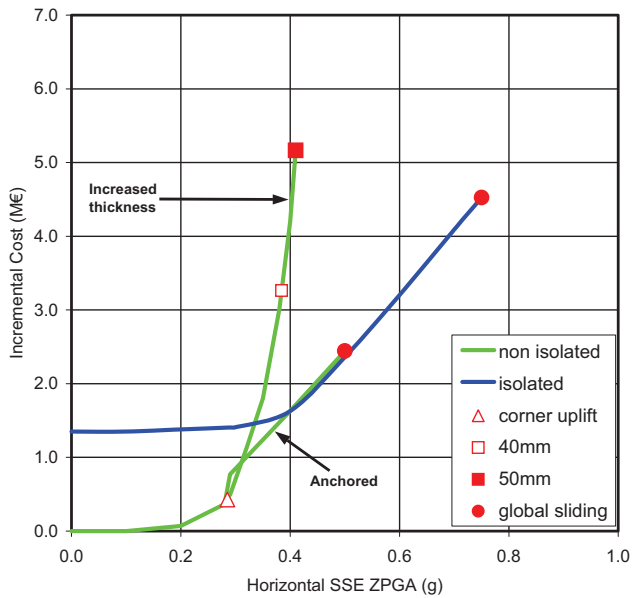

Figure 6. Cost evolution with seismic demand: pile foundation.

The results are combined and compared in [Figure 5](#) for the tank resting on a slab and in [Figure 6](#) for that on a pile foundation. The curves reflect the progressive increases in material quantities imposed by larger seismic demands. Both figures correspond to the case in which an SC spectrum is used for the motions, though the differences with the results obtained with the other spectra are relatively small.

For nonisolated tanks there is a point (identified by a triangle in the figures) beyond which something must be done to avoid damage by corner uplift. A possible solution is to anchor the tank: the discrete jump in one of the “nonisolated” curves is associated with the introduction of this anchorage; in the other “nonisolated” curve the problem is tackled by increasing the thickness of the inner tank. The cost of increasing the thickness quickly becomes higher than that of providing anchorage.

For the specific case of a tank supported on a pile foundation, seismic isolation is not absolutely required until the PGA reaches about 0.50 g, but anchorage must be provided beyond 0.25 g. When considering anchorage, the following should be taken into account:

- Anchorage introduces other “costs” of difficult quantification, beyond the cost of the steel. Technically, it creates undesirable stress concentrations at points of the inner tank, as well as thermal bridges across the thermal insulation under the bottom. Practically, it implies considerable complications and delays in the construction schedule because the anchor straps must be left embedded and protruding when pouring the slab concrete, on which the perimetral beam, thermal insulation and eventually the inner tank will be placed.
- Even though anchorage is a relatively frequent practice, there are some questions as to its reliability during an earthquake. Anchor straps need to be flexible in bending when radial displacements of the inner tank take place; but they are therefore considerably stiffer for movements in the circumferential direction. For straps being deformed in this direction, it is difficult to ensure that they respond in an adequate fashion (for example, without risk of brittle fracture at weld locations).

As a consequence of these considerations, although it is difficult to offer a precise quantification, an isolated tank may be preferable to a nonisolated tank at least in the upper part of the 0.25 g–0.50 g range of peak ground accelerations.

For a tank on a pile foundation the cost of the anchored tank equals that of the isolated tank for accelerations beyond about 0.4 g. However, for tanks on a slab foundation, the incremental cost of the isolated tank always exceeds that of the anchored one for the same range of accelerations. The primary reason is that the isolation of a tank on a slab foundation requires building an additional slab and pedestals, but these extra costs are only partially compensated by the energy savings. On the other hand, the greater stiffness used here for the pile foundation leads to a slightly more expensive inner tank.

For a tank on piles, the solution of increasing the inner tank thickness is practically always more expensive than that of isolating the tank. For a tank founded on a slab, this occurs only beyond 0.5 g, an acceleration level at which the thickness required at the base of the inner tank is about 40 mm.

7. Conclusions

The problems caused by earthquakes on LNG tanks have been reviewed and analyses have been carried out to determine the potential contributions of seismic isolation towards solving those problems or delaying their appearance. The study was centered on a typical modern LNG tank, capable for 160,000 m³. From the work conducted, the following conclusions can be offered:

- a) Seismic isolation may be used to decrease the effects of the horizontal but not the vertical excitations. As a consequence the latter tend to become comparatively much more important in isolated tanks.

- b) It then becomes important to take into account that for vertical motions the liquid mass is distributed as a rigid mass and another mass that oscillates with the first breathing mode of the tank, just as for horizontal motions it is distributed into impulsive and convective masses.
- c) When the design peak ground accelerations are below about 0.25 g–0.30 g, a nonisolated tank is perfectly adequate and some 2 M€ cheaper than an isolated tank. Seismic isolation therefore cannot be justified on technical grounds for sites with such moderate hazard levels.
- d) When the design peak ground accelerations are in the range of 0.25 g–0.30 g to about 0.50 g–0.65 g, a nonisolated tank is still possible but it needs to be anchored, which introduces some uncertainties and involves additional costs of difficult quantification. Even neglecting the latter, the cost difference between the nonisolated and the isolated tank decreases with increasing seismic demands and it even disappears beyond 0.4 g for the isolated 160,000 m³ tank on piles.
- e) If the design peak ground acceleration exceeds about 0.50 g, nonisolated designs are no longer feasible since it becomes impossible to ensure that the inner tank does not undergo gross sliding during the earthquake. Thus, in the range of 0.50 g–0.65 g to 0.90 g, only seismically isolated tanks can be proposed.
- f) When the design peak ground acceleration exceeds 0.90 g even an isolated tank is not feasible due to the inevitability of sliding.
- g) Irrespective of other circumstances, global uplift of the inner tank (the tank loses any contact with the base) is predicted when the design peak ground acceleration attains about 1.0 g for both isolated and nonisolated tanks.

As a final comment, all calculations were based on the response spectrum method. This is a rather conservative procedure, but well established in the industry and which poses few uncertainties. The calculations could have been carried out using direct integration of synthetic accelerograms and generally the results would have been less demanding. The response spectrum method was adopted because of its wider industrial acceptance and the possible sensitivity of the results to the specific accelerograms.

References

- [AASHTO 2000] *Guide specifications for seismic isolation design*, 2nd edition, American Association of State Highway and Transportation Officials, Washington, DC, 2000. 3rd edition published in 2010.
- [API 2004] *Design and construction of large, welded, low-pressure storage tanks*, 10th edition, American Petroleum Institute, Washington, DC, 2004. API STD 620. Addendum 1. 11th edition published in 2010 with addenda 1 & 2.
- [ASCE 1984] *Guidelines for the seismic design of oil and gas pipeline systems*, Committee on Gas and Liquid Fuel Lifelines of the ASCE Technical Council on Lifeline Earthquake Engineering, New York, 1984.
- [ASCE 2000] *Seismic analysis of safety-related nuclear structures and commentary (ASCE 4-98)*, Standard No. 004-98, American Society of Civil Engineers, Reston, VA, 2000.
- [Bergamo et al. 2006a] G. Bergamo, M. G. Castellano, F. Gatti, A. Poggianti, and P. Summers, “[Seismic isolation of spheres at petrochemical facilities](#)”, in *First European Conference on Earthquake Engineering and Seismology* (Geneva, 2006), Swiss Society for Earthquake Engineering and Structural Dynamics, Zürich, 2006. Paper # 1009.
- [Bergamo et al. 2006b] G. Bergamo, M. G. Castellano, F. Gatti, and V. Rebecchi, “Parametric analyses for the seismic isolation of LNG tanks”, in *First European Conference on Earthquake Engineering and Seismology* (Geneva, 2006), Swiss Society for Earthquake Engineering and Structural Dynamics, Zürich, 2006. Poster Presentation ID 1046.

- [Bergamo et al. 2007] G. Bergamo, M. G. Castellano, F. Gatti, J. Marti, A. Poggianti, and P. Summers, “Seismic protection at petrochemical facilities: main results from INDEPTH project”, in *Proceedings of the ASSISI 10th World Conference on Seismic Isolation, Energy Dissipation and Active Vibrations Control of Structures* (Istanbul, 2007), 2007.
- [Böhler and Baumann 1999] J. Böhler and T. Baumann, “Different numerical models for the hysteretic behaviour of HDRB’s on the dynamic response of base-isolated structures with lumped-mass models under seismic loading”, pp. 267–273 in *Constitutive models for rubber* (Vienna, 1999), edited by A. Dorfmann and A. Muhr, Balkema, Rotterdam, 1999.
- [BSI 1993] *Flat-bottomed, vertical, cylindrical storage tanks for low temperature service*, BS 7777, British Standards Institution, London, 1993, Available at <http://tinyurl.com/bsi7777>.
- [Castellano et al. 2006] M. G. Castellano, A. Poggianti, and P. Summers, “Seismic retrofit of spheres using energy-dissipating braces”, in *First European Conference on Earthquake Engineering and Seismology* (Geneva, 2006), Swiss Society for Earthquake Engineering and Structural Dynamics, Zürich, 2006. Paper # 1001.
- [CEN 2004] *Eurocode 8: Design of structures for earthquake resistance - Part 1: General rules, seismic actions and rules for buildings*, EN 1998-1:2004, European Committee for Standardization, Brussels, 2004, Available at <http://tinyurl.com/bs-en-1998-1-2004>.
- [CEN 2006] *Design and manufacture of site built, vertical, cylindrical, flat-bottomed steel tanks for the storage of refrigerated, liquefied gases with operating temperatures between 0°C and –165°C*, EN 14620, European Committee for Standardization, Brussels, 2006, Available at <http://tinyurl.com/bs-en-14620>.
- [CEN 2007] *Installation and equipment for liquefied natural gas. Design of onshore installations*, EN 1473, European Committee for Standardization, Brussels, 2007, Available at <http://tinyurl.com/bs-en-1473-2007>.
- [Cho et al. 2004] K. H. Cho, M. K. Kim, Y. M. Lim, and S. Y. Cho, “Seismic response of base-isolated liquid storage tanks considering fluid-structure-soil interaction in time domain”, *Soil Dyn. Earthq. Eng.* **24**:11 (2004), 839–852.
- [Christovasilis and Whittaker 2008] I. P. Christovasilis and A. S. Whittaker, “Seismic analysis of conventional and isolated LNG tanks using mechanical analogs”, *Earthq. Spectra* **24**:3 (2008), 599–616.
- [Crespo et al. 2006] M. Crespo, S. Omnes, and J. Marti, “Benefits of seismic isolation for LNG tanks”, in *First European Conference on Earthquake Engineering and Seismology* (Geneva, 2006), Swiss Society for Earthquake Engineering and Structural Dynamics, Zürich, 2006. Paper # 1083.
- [Gregoriou et al. 2006] V. P. Gregoriou, S. V. Tsinopoulos, and D. L. Karabalis, “Base isolated LNG tanks: seismic analyses and comparison studies”, in *First European Conference on Earthquake Engineering and Seismology* (Geneva, 2006), Swiss Society for Earthquake Engineering and Structural Dynamics, Zürich, 2006. Paper # 1128.
- [Kim et al. 2002] M. K. Kim, Y. M. Lim, S. Y. Cho, K. H. Cho, and K. W. Lee, “Seismic analysis of base-isolated liquid storage tanks using the BE-FE-BE coupling technique”, *Soil Dyn. Earthq. Eng.* **22**:9–12 (2002), 1151–1158.
- [Malhotra 1997] P. K. Malhotra, “Method for seismic base isolation of liquid-storage tanks”, *J. Struct. Eng. (ASCE)* **123**:1 (1997), 113–116.
- [Malhotra 1998] P. K. Malhotra, “New method for seismic isolation of liquid-storage tanks”, *Earthq. Eng. Struct. Dyn.* **26**:8 (1998), 839–847.
- [Manabe and Sakurai 2007] H. Manabe and T. Sakurai, “Seismic analysis of an SPB tank installed in the offshore GBS LNG terminal”, *IHI Eng. Rev.* **40**:2 (2007), 69–73.
- [Naeim and Kelly 1999] F. Naeim and J. M. Kelly, *Design of seismically isolated structures: from theory to practice*, Wiley, New York, 1999.
- [NFPA 2006] *NFPA 59A: Standard for the production, storage, and handling of liquefied natural gas (LNG)*, National Fire Protection Association, Quincy, MA, 2006, Available at <http://tinyurl.com/NFPA-59A-2006>. Revised in 2009.
- [Rötzer et al. 2005] J. Rötzer, H. Douglas, and H. Maurer, “Hazard and safety investigations for LNG tanks, 1: Earthquakes”, *LNG J.* (July/August 2005), 23–24.
- [Shrimali and Jangid 2002] M. K. Shrimali and R. S. Jangid, “Earthquake response of liquid storage tanks with sliding systems”, *J. Seismol. Earthq. Eng.* **4**:2 & 3 (2002), 51–61.
- [Shrimali and Jangid 2004] M. K. Shrimali and R. S. Jangid, “Seismic analysis of base-isolated liquid storage tanks”, *J. Sound Vib.* **275**:1–2 (2004), 59–75.

- [Skinner et al. 1993] R. I. Skinner, W. H. Robinson, and G. H. McVerry, *An introduction to seismic isolation*, Wiley, New York, 1993.
- [Tajirian 1998] F. F. Tajirian, “Base isolation design for civil components and civil structures”, in *Structural engineering world wide 1998: proceedings of the Structural Engineers World Congress* (San Francisco, 1998), edited by N. K. Srivastava, Elsevier, Amsterdam, 1998.
- [Veletsos and Tang 1986] A. S. Veletsos and Y. Tang, “Dynamics of vertically excited liquid storage tanks”, *J. Struct. Eng. (ASCE)* **112**:6 (1986), 1228–1246.
- [Veletsos and Tang 1990] A. S. Veletsos and Y. Tang, “Soil-structure interaction effects for laterally excited liquid storage tanks”, *Earthq. Eng. Struct. Dyn.* **19**:4 (1990), 473–496.
- [Wang et al. 2001] Y.-P. Wang, M.-C. Teng, and K.-W. Chung, “Seismic isolation of rigid cylindrical tanks using friction pendulum bearings”, *Earthq. Eng. Struct. Dyn.* **30**:7 (2001), 1083–1099.

Received 1 Mar 2010. Accepted 30 Sep 2010.

JOAQUÍN MARTÍ: joaquin.marti@principia.es
PRINCIPIA Ingenieros Consultores, Velázquez, 94, 28006 Madrid, Spain

MARÍA CRESPO: maria.crespo@principia.es
PRINCIPIA Ingenieros Consultores, Velázquez, 94, 28006 Madrid, Spain

FRANCISCO MARTÍNEZ: francisco.martinez@principia.es
PRINCIPIA Ingenieros Consultores, Velázquez, 94, 28006 Madrid, Spain

SEISMIC ISOLATION AND PROTECTIVE SYSTEMS

<http://pjm.math.berkeley.edu/siaps/>

EDITOR-IN-CHIEF

GAINMARIO BENZONI University of California, San Diego, USA

ASSOCIATE EDITORS

JAMES M. KELLY University of California, Berkeley, USA
DAVID WHITTAKER Technical Director of Structural Engineering, Beca, New Zealand
MUSTAFA ERDIK Bogazici University, Istanbul, Turkey

ADDITIONAL EDITORIAL BOARD MEMBERS

MASSIMO FORNI ENEA, Italy
KEITH FULLER Consultant, United Kingdom
ALESSANDRO MARTELLI ENEA, Italy

PRODUCTION

SILVIO LEVY Scientific Editor

See inside back cover or <http://www.jomms.org> for submission guidelines.

SIAPS (ISSN 2150–7902) is published in electronic form only. The subscription price for 2010 is US \$150/year. Subscriptions, requests for back issues, and changes of address should be sent to Mathematical Sciences Publishers, Department of Mathematics, University of California, Berkeley, CA 94720–3840.

SIAPS peer-review and production is managed by EditFLOW™ from Mathematical Sciences Publishers.

PUBLISHED BY

 **mathematical sciences publishers**
<http://www.mathscipub.org>

A NON-PROFIT CORPORATION

Typeset in L^AT_EX

©Copyright 2010 by Mathematical Sciences Publishers

<i>Letter from the President</i> Keith Fuller	1
<i>Assessment of performance degradation in energy dissipators installed on bridge structures</i> Gianmario Benzoni and Carmen Amaddeo	3
<i>Base isolation: design and optimization criteria</i> Paolo Clemente and Giacomo Buffarini	17
<i>Stability and post-buckling behavior in nonbolted elastomeric isolators</i> James M. Kelly and Maria Rosaria Marsico	41
<i>Design criteria for added dampers and supporting braces</i> Giuseppe Lomiento, Noemi Bonessio and Franco Braga	55
<i>Seismic isolation and other antiseismic systems: Recent applications in Italy and worldwide</i> Alessandro Martelli and Massimo Forni	75
<i>Seismic isolation of liquefied natural gas tanks: a comparative assessment</i> Joaquín Martí, María Crespo and Francisco Martínez	123