

Remarks on 2–dimensional HQFTs

MIHAI D STAIC
VLADIMIR TURAEV

We introduce and study algebraic structures underlying 2–dimensional Homotopy Quantum Field Theories (HQFTs) with arbitrary target spaces. These algebraic structures are formalized in the notion of a twisted Frobenius algebra. Our work generalizes results of Brightwell, Turner and the second author on 2–dimensional HQFTs with simply connected or aspherical targets.

57R56

Introduction

A fruitful idea in topology is to construct invariants of manifolds that behave functorially with respect to gluings of manifolds along the boundary. More formally, one associates to every closed oriented d –dimensional manifold M a finite dimensional vector space V_M and to every compact oriented $(d+1)$ –dimensional cobordism (W, M, N) a homomorphism $\tau_W : V_M \rightarrow V_N$. The conditions satisfied by (V, τ) in order to obtain a consistent theory are formalized in the notion of a $(d+1)$ –dimensional Topological Quantum Field Theory (TQFT); see Atiyah [1]. The second author introduced more general Homotopy Quantum Field Theories (HQFTs) [5]. One can think of a $(d+1)$ –dimensional HQFT as a TQFT for a d –dimensional manifolds and $(d+1)$ –dimensional cobordisms endowed with maps to a fixed space X .

The 1–dimensional HQFTs with target X are easily classified in terms of finite dimensional representations of $\pi_1(X)$. A study of 2–dimensional HQFTs is more involved and leads to interesting algebra. For contractible X , the category of 2–dimensional HQFTs with target X is equivalent to the category of 2–dimensional TQFTs and is known to be equivalent to the category of commutative finite-dimensional Frobenius algebras. If $X = K(G, 1)$ is an Eilenberg–Mac Lane space determined by a group G , then the category of 2–dimensional HQFTs with target X is equivalent to the category of so-called crossed Frobenius G –algebras [5]. If $X = K(A, 2)$ is an Eilenberg–Mac Lane space determined by an abelian group A , then the category of 2–dimensional HQFTs with target X is equivalent to the category of Frobenius A –algebras; see Brightwell and Turner [2].

In this paper we address the case where both groups $G = \pi_1(X)$ and $A = \pi_2(X)$ are allowed to be nontrivial. An important role will be played by the first k -invariant $k \in H^3(G, A)$ of X . We shall introduce and study algebraic structures underlying 2-dimensional HQFTs with target X . We call them twisted Frobenius algebras or, shorter, TF-algebras over (G, A, k) . Briefly speaking, a TF-algebra is a G -graded algebra of A -modules which is associative up to a 3-cocycle representing k and which satisfies a form of commutativity. This work is a step towards classification of 2-dimensional HQFTs with target X (for a different approach, see Porter and Turaev [4]).

The paper is organized as follows. We introduce TF-algebras in Section 1. In Section 2 we recall the notion of an HQFT and the definition of the first k -invariant of a topological space. In Section 3 we derive from any 2-dimensional HQFT the underlying TF-algebra. In Section 4 we compute the underlying TF-algebras of the cohomological 2-dimensional HQFTs.

Throughout the paper the symbol K denotes a field and $\otimes = \otimes_K$.

Acknowledgments The work of M Staic was partially supported by the CNCSIS project ‘‘Hopf algebras, cyclic homology and monoidal categories’’, contract number 560/2009. The work of V Turaev was partially supported by NSF grants DMS-0707078 and DMS-0904262.

1 Twisted Frobenius algebras

1.1 Preliminaries

In this section G is a group with neutral element ε and A is a left G -module with neutral element $1 = 1_A$. We use multiplicative notation for the group operation in A . As usual, the group ring of A with coefficients in K is denoted $K[A]$. The action of $\alpha \in G$ on $a \in A$ is denoted by αa .

To calculate the cohomology $H^*(G, A)$, we use the standard cochain complex

$$C^0(G, A) \xrightarrow{\delta^0} C^1(G, A) \xrightarrow{\delta^1} C^2(G, A) \xrightarrow{\delta^2} C^3(G, A) \xrightarrow{\delta^3} C^4(G, A) \rightarrow \dots$$

where $C^n(G, A) = \text{Map}(G^n, A)$ for any $n \geq 0$. For small n , the coboundary homomorphism $\delta^n: C^n(G, A) \rightarrow C^{n+1}(G, A)$ is given by the following formulas:

$$\delta^0(a)(\alpha) = \alpha a a^{-1}$$

for any $a \in A = C^0(G, A)$ and $\alpha \in G$,

$$\delta^1(\psi)(\alpha, \beta) = {}^\alpha\psi(\beta) \psi(\alpha\beta)^{-1} \psi(\alpha)$$

for any $\psi \in C^1(G, A)$ and $\alpha, \beta \in G$,

$$\delta^2(\omega)(\alpha, \beta, \gamma) = {}^\alpha\omega(\beta, \gamma) \omega(\alpha\beta, \gamma)^{-1} \omega(\alpha, \beta\gamma) \omega(\alpha, \beta)^{-1}$$

for any $\omega \in C^2(G, A)$ and $\alpha, \beta, \gamma \in G$, and

$$\delta^3(\chi)(\alpha, \beta, \gamma, \rho) = {}^\alpha\chi(\beta, \gamma, \rho) \chi(\alpha\beta, \gamma, \rho)^{-1} \chi(\alpha, \beta\gamma, \rho) \chi(\alpha, \beta, \gamma\rho)^{-1} \chi(\alpha, \beta, \gamma)$$

for any $\chi \in C^3(G, A)$ and $\alpha, \beta, \gamma, \rho \in G$.

1.2 Definition of TF–algebras

Fix from now on a normalized 3–cocycle $\kappa: G^3 \rightarrow A$. Thus, for all $\alpha, \beta, \gamma, \rho \in G$,

$${}^\alpha\kappa(\beta, \gamma, \rho) \kappa(\alpha\beta, \gamma, \rho)^{-1} \kappa(\alpha, \beta\gamma, \rho) \kappa(\alpha, \beta, \gamma\rho)^{-1} \kappa(\alpha, \beta, \gamma) = 1.$$

The word “normalized” means that for all $\alpha, \beta \in G$,

$$\kappa(\varepsilon, \alpha, \beta) = \kappa(\alpha, \varepsilon, \beta) = \kappa(\alpha, \beta, \varepsilon) = 1.$$

A *twisted Frobenius algebra (TF–algebra)* over the triple (G, A, κ) is a G –graded $K[A]$ –module $V = \bigoplus_{\alpha \in G} V_\alpha$ such that the following properties hold:

(a) (*Underlying module and action of A*) The underlying K –vector space of V_α is finite-dimensional and for all $\alpha \in G$, $u \in V_\alpha$ and $a \in A$,

$$(1) \quad au = {}^\alpha au.$$

(b) (*Multiplication*) We have a K –bilinear multiplication $V \times V \rightarrow V$ carrying $V_\alpha \times V_\beta$ to $V_{\alpha\beta}$ for all $\alpha, \beta \in G$. For any $u \in V_\alpha$, $v \in V_\beta$, $w \in V_\gamma$ with $\alpha, \beta, \gamma \in G$,

$$(2) \quad (uv)w = \kappa(\alpha, \beta, \gamma) u(vw).$$

There is a unit element $1_V \in V_\varepsilon$ such that $1_V u = u 1_V = u$ for all $u \in V$.

(c) (*Inner product*) We have a nondegenerate symmetric K –bilinear form

$$\eta_\varepsilon: V_\varepsilon \otimes V_\varepsilon \rightarrow K$$

such that for all $\alpha \in G$, the pairing

$$(3) \quad V_\alpha \otimes V_{\alpha^{-1}} \rightarrow K, \quad u \otimes v \mapsto \eta_\varepsilon(uv \otimes 1_V)$$

(where $u \in V_\alpha$, $v \in V_{\alpha^{-1}}$) is nondegenerate.

(d) (*Projective action of G*) For each $\beta \in G$, we have a K -linear isomorphism $\varphi_\beta: V \rightarrow V$ carrying V_α to $V_{\beta\alpha\beta^{-1}}$ for all α and such that

$$(4) \quad \varphi_\beta(av) = {}^\beta a \varphi_\beta(v) \quad \text{for any } a \in A \text{ and } v \in V,$$

$$(5) \quad \varphi_\beta|_{V_\beta} = \text{id}_{V_\beta}: V_\beta \rightarrow V_\beta,$$

$$(6) \quad \varphi_\beta(1_V) = 1_V,$$

$$(7) \quad vu = \varphi_\beta(u)v \quad \text{for any } u \in V, v \in V_\beta,$$

$$(8) \quad \eta_\varepsilon(\varphi_\beta(u) \otimes \varphi_\beta(v)) = \eta_\varepsilon(u \otimes v) \quad \text{for any } u, v \in V_\varepsilon,$$

$$(9) \quad \varphi_\beta(u) \varphi_\beta(v) = l_{\alpha,\gamma}^\beta \varphi_\beta(uv) \quad \text{for any } \alpha, \gamma \in G \text{ and } u \in V_\alpha, v \in V_\gamma,$$

where $l_{\alpha,\gamma}^\beta = \kappa(\beta\alpha\beta^{-1}, \beta\gamma\beta^{-1}, \beta) \kappa(\beta\alpha\beta^{-1}, \beta, \gamma)^{-1} \kappa(\beta, \alpha, \gamma) \in A$,

$$(10) \quad \varphi_{\gamma\beta}|_{V_\alpha} = h_{\gamma,\beta}^\alpha (\varphi_\gamma \circ \varphi_\beta)|_{V_\alpha} \quad \text{for all } \alpha, \beta, \gamma \in G,$$

where $h_{\gamma,\beta}^\alpha = \kappa(\gamma\beta\alpha(\gamma\beta)^{-1}, \gamma, \beta) \kappa(\gamma, \beta\alpha\beta^{-1}, \beta)^{-1} \kappa(\gamma, \beta, \alpha) \in A$.

(e) (*The trace condition*) For any $\alpha, \beta \in G$ and $c \in V_{\alpha\beta\alpha^{-1}\beta^{-1}}$,

$$(11) \quad \text{Tr}(\kappa(\alpha\beta\alpha^{-1}\beta^{-1}, \beta, \alpha) \mu_c \varphi_\beta: V_\alpha \rightarrow V_\alpha) \\ = \text{Tr}(\kappa(\alpha\beta\alpha^{-1}\beta^{-1}, \beta\alpha\beta^{-1}, \beta) \varphi_\alpha^{-1} \mu_c: V_\beta \rightarrow V_\beta),$$

where μ_c is left multiplication $V \rightarrow V, v \mapsto cv$ by c and Tr is the standard trace of linear maps.

We have the following elementary consequences of the definition. The $K[A]$ -bilinearity of multiplication in V implies that

$$(12) \quad a(uv) = (au)v = u(av)$$

for all $a \in A$ and $u, v \in V$. Note that if $u \in V_\alpha$ and $v \in V_\beta$, then for all $a \in A$,

$${}^\alpha a(uv) = ({}^\alpha au)v = (au)v = a(uv)$$

and similarly ${}^\beta a(uv) = a(uv)$. Formula (10) applied to $\gamma = \beta = \varepsilon$ implies that

$$(13) \quad \varphi_\varepsilon = \text{id}: V \rightarrow V.$$

In the following lemma and in the sequel the pairing (3) is denoted by η_α .

Lemma 1.1 For any $a \in A, u \in V_\alpha, v \in V_{\alpha^{-1}}$ with $\alpha \in G$,

$$\eta_\alpha(au \otimes v) = \eta_\alpha(u \otimes av),$$

$$\eta_\alpha(u \otimes v) = \eta_{\alpha^{-1}}(\kappa(\alpha^{-1}, \alpha, \alpha^{-1})^{-1} v \otimes u).$$

For any $\alpha, \beta \in G, u \in V_\alpha, v \in V_{\alpha^{-1}},$

$$\eta_{\beta\alpha\beta^{-1}}(\varphi_\beta(u) \otimes \varphi_\beta(v)) = \eta_\alpha(l_{\alpha, \alpha^{-1}}^\beta u \otimes v).$$

For any $\alpha, \beta \in G, u \in V_\alpha, v \in V_\beta$ and $w \in V_{(\alpha\beta)^{-1}},$

$$\eta_{\alpha\beta}(uv \otimes w) = \eta_\alpha(\kappa(\alpha, \beta, (\alpha\beta)^{-1}) u \otimes vw).$$

Proof We check only the first two identities leaving the other two to the reader. For the first identity, we have

$$\begin{aligned} \eta_\alpha(au \otimes v) &= \eta_\varepsilon((au)v \otimes 1_V) \\ &= \eta_\varepsilon(u(av) \otimes 1_V) \\ &= \eta_\alpha(u \otimes av). \end{aligned}$$

Formulas (5), (13) and (10) with $\gamma = \alpha, \beta = \alpha^{-1}$ imply the identity $\varphi_\alpha(v) = \kappa(\alpha^{-1}, \alpha, \alpha^{-1})^{-1} v$ for all $v \in V_{\alpha^{-1}}$. Therefore

$$\begin{aligned} \eta_\alpha(u \otimes v) &= \eta_\varepsilon(uv \otimes 1_V) \\ &= \eta_\varepsilon(\varphi_\alpha(v)u \otimes 1_V) \\ &= \eta_\varepsilon(\kappa(\alpha^{-1}, \alpha, \alpha^{-1})^{-1} vu \otimes 1_V) \\ &= \eta_{\alpha^{-1}}(\kappa(\alpha^{-1}, \alpha, \alpha^{-1})^{-1} v \otimes u). \end{aligned} \quad \square$$

Given $z \in K^*$ and a TF–algebra, we can multiply the inner product η_ε by z (keeping the rest of the data) and obtain thus a new TF–algebra. This operation on TF–algebras is called z –rescaling.

Let V, W be TF–algebras over (G, A, κ) . A $K[A]$ –isomorphism $f: V \rightarrow W$ is an *isomorphism* of TF–algebras if f is an isomorphism of algebras such that $\eta_\varepsilon(f(u) \otimes f(v)) = \eta_\varepsilon(u \otimes v)$ for all $u, v \in V_\varepsilon$ and $f\varphi_\beta = \varphi_\beta f$ for all $\beta \in G$.

1.3 Examples

The definition of a TF–algebra over (G, A, κ) generalizes both the notion of a crossed Frobenius G –algebra [5] and the notion of an A –Frobenius algebra [2]. Consequently we have the following two sources of examples.

Example 1.2 If L is a crossed Frobenius G –algebra, then L is a TF–algebra over (G, A, κ) where A is the trivial group and κ is the trivial cocycle.

Example 1.3 If V is an A –Frobenius algebra, then V is a TF–algebra over (G, A, κ) where G is the trivial group and κ is the trivial cocycle.

Further examples of TF–algebras are constructed in Section 4.

1.4 Coboundary equivalence

Let $\kappa: G^3 \rightarrow A$ be a normalized 3-cocycle. Given a normalized 2-cochain $\omega: G^2 \rightarrow A$, the map $\kappa' = \delta^2(\omega)$, $\kappa: G^3 \rightarrow A$ is a normalized 3-cocycle cohomological to κ . Using ω , we can transform a TF-algebra V over (G, A, κ) into a TF-algebra V^ω over (G, A, κ') as follows. The underlying G -graded $K[A]$ -modules of V^ω and V are the same. The inner product on $V_\varepsilon^\omega = V_\varepsilon$ is the same as in V . Multiplication \cdot^ω on V^ω is defined by

$$u \cdot^\omega v = \omega(\alpha, \beta)^{-1} u \cdot v,$$

for $u \in V_\alpha$, $v \in V_\beta$, where \cdot is multiplication in V . Given $\beta \in G$, the automorphism φ_β^ω of V^ω is defined by

$$\varphi_\beta^\omega|_{V_\alpha} = \omega(\beta, \alpha)^{-1} \omega(\beta\alpha\beta^{-1}, \beta) \varphi_\beta|_{V_\alpha}$$

for all $\alpha \in G$. Direct computations show that V^ω is a TF-algebra over (G, A, κ') . We say that V^ω is obtained from V by a *coboundary transformation*. This transformation defines an equivalence between the category of TF-algebras over (G, A, κ) and their isomorphisms and the category of TF-algebras over (G, A, κ') and their isomorphisms.

Given $k \in H^3(G, A)$, the coboundary transformations and the isomorphisms generate an equivalence relation on the class of TF-algebras over the triples (G, A, κ) where $\kappa: G^3 \rightarrow A$ runs over all normalized 3-cocycles representing k . This relation is called *coboundary equivalence* and the corresponding equivalence classes are called TF-algebras over (G, A, k) .

2 Preliminaries on HQFTs and k -invariants

2.1 HQFTs

We recall the definition of an HQFT from [5; 6]. We say that a topological space is *pointed* if all its connected components are provided with base points. By *maps* of pointed spaces we mean continuous maps carrying base points to base points.

Fix a pointed path connected topological space X . An X -*manifold* is a pair (M, g) , where M is a pointed closed oriented manifold and g is a map $M \rightarrow X$. An X -*homeomorphism* between (M, g) and (M', g') is an orientation preserving (and base point preserving) homeomorphism $f: M \rightarrow M'$ such that $g = g'f$. An empty set is considered as an X -manifold of any given dimension.

An X -*cobordism* between X -manifolds (M_0, g_0) and (M_1, g_1) is an oriented compact cobordism (W, M_0, M_1) endowed with a map $g: W \rightarrow X$ such that $\partial W =$

$(-M_0) \amalg M_1$ and $g|_{M_i} = g_i$ for $i = 1, 2$. Note that W is not required to be pointed, but M_0 and M_1 are pointed. An X –homeomorphism between two X –cobordisms (W, M_0, M_1, g) and (W', M'_0, M'_1, g') is an orientation preserving homeomorphism of triples $F: (W, M_0, M_1) \rightarrow (W', M'_0, M'_1)$ such that $g = g'F$ and F restricts to X –homeomorphisms $M_0 \rightarrow M'_0$ and $M_1 \rightarrow M'_1$. For example, for any X –manifold (M, g) we have the cylinder cobordism $(M \times [0, 1], M \times 0, M \times 1, \bar{g})$ between two copies of (M, g) . Here \bar{g} is the composition of the projection $M \times [0, 1] \rightarrow M$ with g . Any X –homeomorphism of X –manifolds multiplied by $\text{id}_{[0,1]}$ yields an X –homeomorphism of the corresponding cylinder cobordisms.

A $(d+1)$ –dimensional Homotopy Quantum Field Theory (V, τ) with target X assigns a finite-dimensional K –vector space V_M to any d –dimensional X –manifold, a K –isomorphism $f_\#: V_M \rightarrow V_{M'}$ to any X –homeomorphism of d –dimensional X –manifolds $f: M \rightarrow M'$ and a K –homomorphism $\tau(W): V_{M_0} \rightarrow V_{M_1}$ to any $(d+1)$ –dimensional X –cobordism (W, M_0, M_1) . These vector spaces and homomorphisms should satisfy the following axioms:

- (1) For any X –homeomorphisms of d –dimensional X –manifolds $f: M \rightarrow M'$, $f': M' \rightarrow M''$, we have $(f'f)_\# = f'_\#f_\#$.
- (2) For any disjoint d –dimensional X –manifolds M, N , there is a natural isomorphism $V_{M \amalg N} = V_M \otimes V_N$.
- (3) $V_\emptyset = K$.
- (4) For any X –homeomorphism of $(d+1)$ –dimensional X –cobordisms

$$F: (W, M_0, M_1, g) \rightarrow (W', M'_0, M'_1, g'),$$

the following diagram is commutative:

$$\begin{CD} V_{(M_0, g|_{M_0})} @>(F|_{M_0})_\#>> V_{(M'_0, g'|_{M'_0})} \\ @VV\tau(W, g)V @VV\tau(W', g')V \\ V_{(M_1, g|_{M_1})} @>(F|_{M_1})_\#>> V_{(M'_1, g'|_{M'_1})} \end{CD}$$

- (5) If a $(d+1)$ –dimensional X –cobordism W is a disjoint union of X –cobordisms W_1, W_2 , then $\tau(W) = \tau(W_1) \otimes \tau(W_2)$.
- (6) If an X –cobordism (W, M_0, M_1) is obtained from two $(d+1)$ –dimensional X –cobordisms (W_0, M_0, N) and (W_1, N', M_1) by gluing along an X –homeomorphism $f: N \rightarrow N'$, then

$$\tau(W) = \tau(W_1) f_\# \tau(W_0): V_{M_0} \rightarrow V_{M_1}.$$

(7) For any d -dimensional X -manifold (M, g) ,

$$\tau(M \times [0, 1], M \times 0, M \times 1, \bar{g}) = \text{id}: V_M \rightarrow V_M,$$

where we identify $M \times 0$ and $M \times 1$ with M in the obvious way and the triple $(M \times [0, 1], M \times 0, M \times 1, \bar{g})$ is the cylinder cobordism over (M, g) .

(8) For any $(d+1)$ -dimensional X -cobordism (W, M_0, M_1, g) , the homomorphism $\tau(W)$ is preserved under homotopies of g constant on $\partial W = M_0 \amalg M_1$.

Remark In this definition we follow [6] rather than [5]. The difference is that Axiom (7) in [6] is weakened in comparison with the corresponding axiom in [5].

For shortness, HQFTs with target X will be also called X -HQFTs. For examples of X -HQFTs, see the second author’s papers [5; 6]. Note here that any cohomology class $\theta \in H^{d+1}(X; K^*)$ determines a $(d+1)$ -dimensional X -HQFT (V^θ, τ^θ) .

An isomorphism of X -HQFTs $\rho: (V, \tau) \rightarrow (V', \tau')$ is a family of K -isomorphisms $\{\rho_M: V_M \rightarrow V'_M\}_M$, where M runs over all d -dimensional X -manifolds, $\rho_\emptyset = \text{id}_K$, $\rho_{M \amalg N} = \rho_M \otimes \rho_N$ for all M, N , and the natural square diagrams associated with the X -homeomorphisms and X -cobordisms are commutative.

2.2 The k -invariant

Let X be a path connected topological space with base point x_0 . We recall from [3] the definition of the first k -invariant of X .

Let $p: [0, 1] \rightarrow S^1 = \{z \in \mathbb{C} \mid |z| = 1\}$ be the map carrying $t \in [0, 1]$ to $-i \exp(-2\pi i t)$. We provide S^1 with clockwise orientation and base point $-i = p(0) = p(1)$. Set $G = \pi_1(X, x_0)$ and recall that $A = \pi_2(X, x_0)$ is a left G -module in the standard way. For each $\alpha \in G$, fix a loop $u_\alpha: S^1 \rightarrow X$ carrying $-i$ to x_0 and representing α . We assume that the loop u_ε representing the neutral element $\varepsilon \in G$ is the constant path at x_0 . Fix a 2-simplex Δ_2 with vertices v_0, v_1, v_2 . For every $\alpha, \beta \in G$, fix a map $f_{\alpha, \beta}: \Delta_2 \rightarrow X$ such that for all $t \in [0, 1]$,

$$\begin{aligned} f_{\alpha, \beta}((1-t)v_0 + tv_1) &= u_\alpha p(t), & f_{\alpha, \beta}((1-t)v_1 + tv_2) &= u_\beta p(t), \\ f_{\alpha, \beta}((1-t)v_0 + tv_2) &= u_{\alpha\beta} p(t). \end{aligned}$$

We assume that $f_{\varepsilon, \varepsilon}$ is the constant map $\Delta_2 \rightarrow \{x_0\}$ and that for all $\alpha \in G$, the maps $f_{\varepsilon, \alpha}$ and $f_{\alpha, \varepsilon}$ are the standard “constant” homotopies between two copies of u_α . We call the collection $\Omega = \{\{u_\alpha\}_{\alpha \in G}; \{f_{\alpha, \beta}\}_{\alpha, \beta \in G}\}$ a basic system of loops and triangles in X .

Figures 1–14 below represent X –surfaces using the following conventions. The vertices in each figure are labeled by integers; the vertex labeled by an integer i is denoted v_i . With every edge in the figure we associate an element of G called its label. For some edges, the labels are indicated by Greek letters in the picture. The labels of all the other edges can be computed uniquely using the following rule: in any triangle $v_i v_j v_k$ with $i < j < k$ the label of the edge $v_i v_k$ is the product of the labels of $v_i v_j$ and $v_j v_k$. Each figure below represents a compact oriented surface Σ endowed with a map $f: \Sigma \rightarrow X$. The map f carries all vertices of Σ to the base point $x_0 \in X$. The restriction of f to any edge $v_i v_j$ with $i < j$ and with label $\rho \in G$ is given by $f((1-t)v_i + tv_j) = u_\rho p(t)$ for all $t \in [0, 1]$. The restriction of f to any triangle $v_i v_j v_k$ with $i < j < k$ is given by

$$f(t_0 v_i + t_1 v_j + t_2 v_k) = f_{\rho, \eta}(t_0 v_0 + t_1 v_1 + t_2 v_2),$$

where ρ, η are the labels of $v_i v_j$ and $v_j v_k$ respectively and t_0, t_1, t_2 run over nonnegative real numbers whose sum is equal to 1. The map $f: \Sigma \rightarrow X$ is considered up to homotopy constant on $\partial \Sigma$.

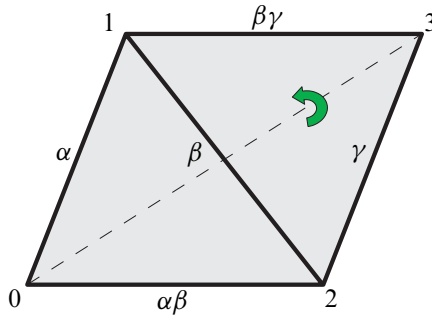

Figure 1: A map $\partial \Delta_3 \rightarrow X$

Let Δ_3 be the standard 3–simplex with vertices v_0, v_1, v_2, v_3 . Given $\alpha, \beta, \gamma \in G$, **Figure 1** describes a map from the 2–sphere $\partial \Delta_3$ to X . Here the labels of the edges $v_0 v_2, v_1 v_3$, and $v_0 v_3$ are $\alpha\beta, \beta\gamma$, and $\alpha\beta\gamma$, respectively. We take v_0 as the base point of $\partial \Delta_3$. With this choice, the map $\partial \Delta_3 \rightarrow X$ in **Figure 1** represents an element of $A = \pi_2(X, x_0)$ denoted $\kappa(\alpha, \beta, \gamma)$. This defines a map $\kappa = \kappa^\Omega: G^3 \rightarrow A$. It is known that κ is a cocycle. It follows from the definitions (and from the choice of the maps $f_{\alpha, \varepsilon}, f_{\varepsilon, \alpha}$) that κ is normalized in the sense of **Section 1.1**. The cohomology class of κ in $H^3(G, A)$ is independent of the choice of Ω . This cohomology class is the first k –invariant of X .

3 The TF–algebra underlying a 2–dimensional HQFT

Let X be a path connected topological space with base point x_0 . We derive from any 2–dimensional X –HQFT (V, τ) its *underlying TF–algebra*.

For shortness, one–dimensional X –manifolds will be called X –*curves* and two–dimensional X –cobordisms will be called X –*surfaces*. We say that two X –surfaces with the same bases

$$(W, M_0, M_1, g: W \rightarrow X) \quad \text{and} \quad (W', M_0, M_1, g': W' \rightarrow X)$$

are *h–equivalent* if there is a homeomorphism $F: W \rightarrow W'$ constant on the boundary and such that $g'F: W \rightarrow X$ is homotopic to g via a homotopy constant on the boundary. The axioms of an HQFT imply that then $\tau(W) = \tau(W'): V_{M_0} \rightarrow V_{M_1}$.

Fix a basic system of loops and triangles $\Omega = \{\{u_\alpha\}_{\alpha \in G}; \{f_{\alpha, \beta}\}_{\alpha, \beta \in G}\}$ in X , where $G = \pi_1(X, x_0)$. Let $\kappa: G^3 \rightarrow A = \pi_2(X, x_0)$ be the cocycle constructed in Section 2.2. We construct a TF–algebra V^Ω over (G, A, κ) in several steps.

Step 1 (Underlying module and action of A) For each $\alpha \in G$, consider the pointed oriented circle S^1 and the map $u_\alpha: S^1 \rightarrow X$ as in Section 2.2. The pair (S^1, u_α) is an X –curve. Set $V_\alpha = V_{(S^1, u_\alpha)}$. By the definition of an HQFT, V_α is a finite–dimensional K –vector space.

For all $\alpha \in G$, the group $A = \pi_2(X, x_0)$ acts on V_α by

$$av = \tau(S(\alpha, a))(v),$$

where $a \in A$, $v \in V_\alpha$, and $S(\alpha, a)$ is the X –annulus obtained as a connected sum of the cylinder cobordism over (S^1, u_α) and a map $S^2 \rightarrow X$ representing a . The X –annulus $S(\alpha, a)$ is shown in the left part of Figure 2. Here and below we use

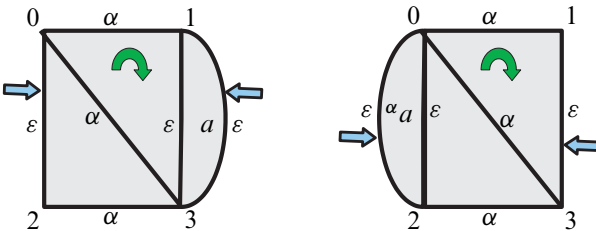

Figure 2: The X –annulus $S(\alpha, a)$

external arrows to indicate the edges glued to each other (keeping the surface oriented).

Observe that the X –annulus in the right part of Figure 2 is h–equivalent to $S(\alpha, a)$. Therefore, $av = {}^\alpha av$ for all $a \in A$ and $v \in V_\alpha$.

Step 2 (Multiplication) For $\alpha, \beta \in G$, consider the X –cobordism (a disk with two holes) $D(\alpha, \beta)$ in Figure 3. Composing the map

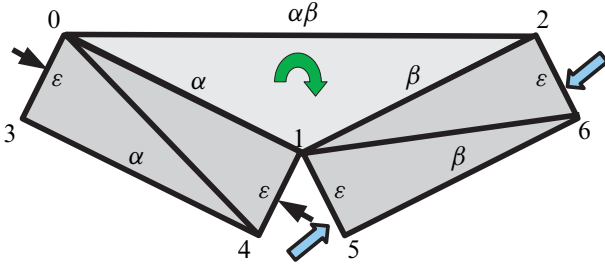

Figure 3: The X –disk with 2 holes $D(\alpha, \beta)$

$$V_\alpha \times V_\beta \rightarrow V_\alpha \otimes V_\beta, \quad (u, v) \mapsto u \otimes v$$

with the homomorphism

$$\tau(D(\alpha, \beta)): V_\alpha \otimes V_\beta \rightarrow V_{\alpha\beta}$$

we obtain a K –linear multiplication $V_\alpha \times V_\beta \rightarrow V_{\alpha\beta}$. This extends to multiplication in $\bigoplus_{\alpha \in G} V_\alpha$ by linearity.

It is clear that for any $a \in A$, the gluing of $S(\alpha, a)$ to $D(\alpha, \beta)$ along the left bottom base of $D(\alpha, \beta)$ and the gluing of $S(\alpha\beta, a)$ to $D(\alpha, \beta)$ along the top base of $D(\alpha, \beta)$ yield h –equivalent X –surfaces. Applying τ , we obtain $(au)v = a(uv)$ for any $u \in V_\alpha$ and $v \in V_\beta$. Similarly, $(au)v = u(av)$. Hence, multiplication in $\bigoplus_{\alpha \in G} V_\alpha$ is $K[A]$ –bilinear.

To check the twisted associativity (2), note that $(uv)w$ is computed by applying τ to the X –surface (a disk with three holes) obtained by gluing $D(\alpha, \beta)$ to $D(\alpha\beta, \gamma)$. Similarly, $u(vw)$ is computed by applying τ to the X –surface obtained by gluing $D(\beta, \gamma)$ to $D(\alpha, \beta\gamma)$. These X –surfaces are shown in Figure 4 where the external arrows indicating the gluing of sides are omitted. It is easy to see that the left X –surface is h –equivalent to a connected sum of the right X –surface with the map $S^2 \rightarrow X$ used to define $\kappa(\alpha, \beta, \gamma) \in A$. This implies Formula (2). Note for future use that the narrow “collar-type” rectangles in Figure 4 play no role in the argument but are necessary to define the X –surfaces at hand. In some of the figures below we omit these collar rectangles to simplify the figures.

Next consider an oriented 2–disk B mapped to $\{x_0\} \subset X$ and viewed as an X –cobordism between an empty set and (S^1, u_ε) . We have a map $\tau(B): K \rightarrow V_\varepsilon$, and we set $1_V = \tau(B)(1)$. One easily sees that $1_V u = u 1_V = u$ for all $u \in V$.

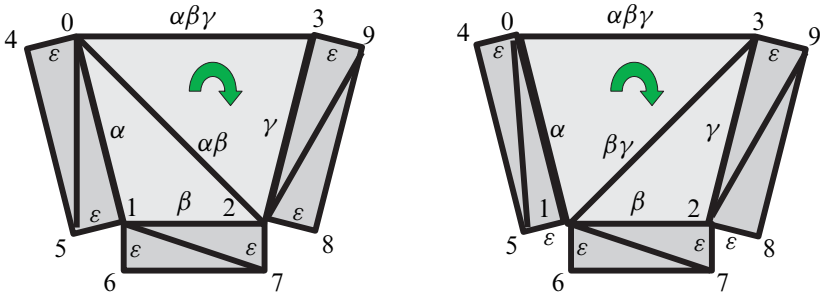

Figure 4: Proof of the identity $(uv)w = \kappa(\alpha, \beta, \gamma)u(vw)$

Step 3 (Inner product) Consider the X -annulus $C_{--}(\alpha, \varepsilon)$ shown in Figure 5. The

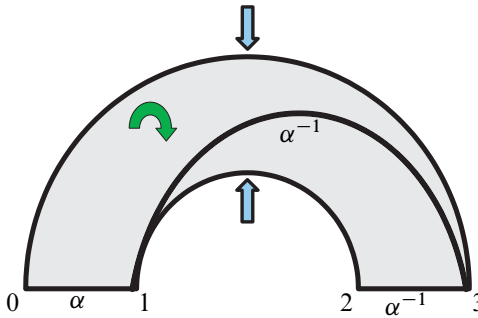

Figure 5: The X -annulus $C_{--}(\alpha, \varepsilon)$

subscript $--$ reflects the fact that the orientation on both boundary components of the annulus is opposite to the orientation induced from the annulus. Set

$$\eta_\alpha = \tau(C_{--}(\alpha, \varepsilon)): V_\alpha \otimes V_{\alpha^{-1}} \rightarrow K.$$

The X -annulus $C_{--}(\alpha, \varepsilon)$ can be obtained by gluing the X -surfaces $C_{--}(\varepsilon, \varepsilon)$, $D(\alpha, \alpha^{-1})$, and B . This yields

$$\eta_\alpha(u \otimes v) = \tau(C_{--}(\alpha, \varepsilon))(u \otimes v) = \eta_\varepsilon(uv \otimes 1_V)$$

for all $u \in V_\alpha$ and $v \in V_{\alpha^{-1}}$.

The X -surfaces shown in Figure 6 are h -equivalent. Applying τ to the surface on the left we get $(\text{id}_{V_{\alpha^{-1}}} \otimes \eta_\alpha)(\iota \otimes \text{id}_{V_{\alpha^{-1}}})$, where ι is a homomorphism $K \rightarrow V_{\alpha^{-1}} \otimes V_\alpha$. Applying τ to the surface on the right we get $\text{id}_{V_{\alpha^{-1}}}$. This results in the equality $(\text{id}_{V_{\alpha^{-1}}} \otimes \eta_\alpha)(\iota \otimes \text{id}_{V_{\alpha^{-1}}}) = \text{id}_{V_{\alpha^{-1}}}$, which implies the nondegeneracy of η_α .

Note finally that the map $C_{--}(\varepsilon, \varepsilon) \rightarrow X$ used to define η_ε is the constant map with value x_0 . This easily implies that the form η_ε is symmetric.

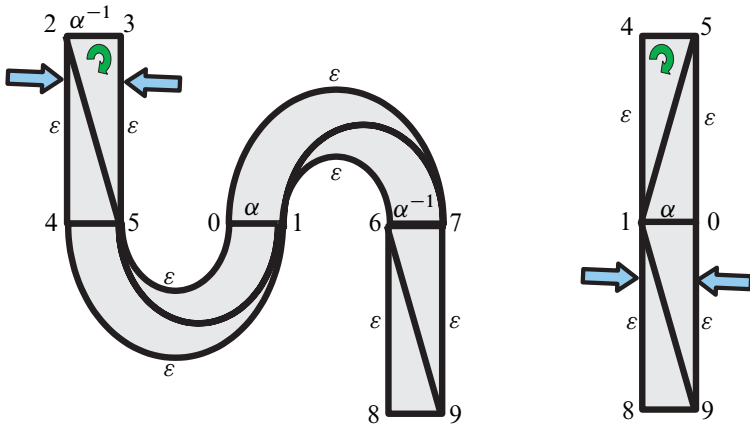

Figure 6: Proof of the nondegeneracy of η_α

Step 4 (Projective action of G) Consider the X -annulus $C_{-+}(\alpha, \beta)$ shown in Figure 7. The subscript $-+$ reflects the fact that the orientation on the boundary

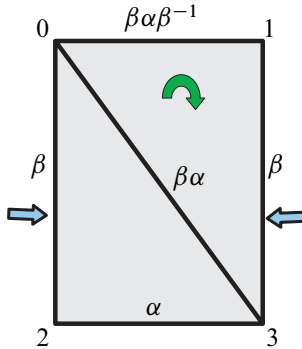

Figure 7: The X -annulus $C_{-+}(\alpha, \beta)$

component corresponding to α is opposite to the orientation induced from the annulus, while the orientation on the boundary component corresponding to $\beta\alpha\beta^{-1}$ is induced from the orientation of the annulus. Set

$$\varphi_\beta = \tau(C_{-+}(\alpha, \beta)): V_\alpha \rightarrow V_{\beta\alpha\beta^{-1}}.$$

The identity $\varphi_\beta(av) = \beta a \varphi_\beta(v)$ for $a \in A$ and $v \in V_\alpha$ follows from the fact the X -annulus obtained by gluing $C_{-+}(\alpha, \beta)$ to $S(\alpha, a)$ is h -equivalent to the X -annulus obtained by gluing $S(\beta\alpha\beta^{-1}, \beta a)$ to $C_{-+}(\alpha, \beta)$.

Figure 8 represents two h -equivalent X -annuli (it is understood that the vertical sides of the right rectangle are glued in the usual way to make an annulus). The left X -annulus

is $C_{-+}(\alpha, \varepsilon)$. The right X -annulus is obtained by gluing $C_{-+}(\alpha, \beta)$ represented by the lower rectangle to an X -annulus $C'(\alpha, \beta)$ represented by the upper rectangle. This proves that φ_β is invertible and $\varphi_\beta^{-1} = \tau(C'(\alpha, \beta))$.

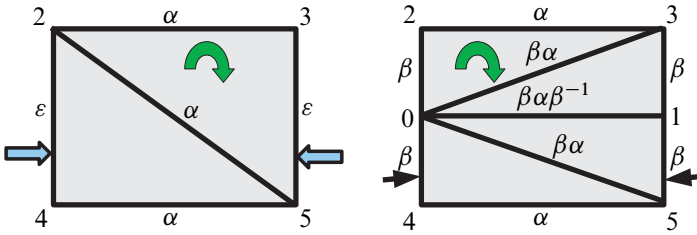

Figure 8: Proof of the invertibility of φ_β

To prove that $\varphi_\beta|_{V_\beta} = \text{id}_{V_\beta}: V_\beta \rightarrow V_\beta$, consider the X -annuli in Figure 9. Using the Dehn twist of an annulus about its core circle, one easily observes that these two X -annuli are h-equivalent. The X -annulus on the right is $C_{-+}(\beta, \varepsilon)$, and the associated map $\varphi_\varepsilon: V_\beta \rightarrow V_\beta$ is the identity by Axiom (7) of an HQFT. It is easy to see that a connected sum of the left X -annulus with the map $S^2 \rightarrow X$ used to define $\kappa(\beta, \varepsilon, \beta) \in A$ is h-equivalent to $C_{-+}(\beta, \beta)$. Since $\kappa(\beta, \varepsilon, \beta) = 1$, we obtain $\text{id}_{V_\beta} = \varphi_\beta|_{V_\beta}$.

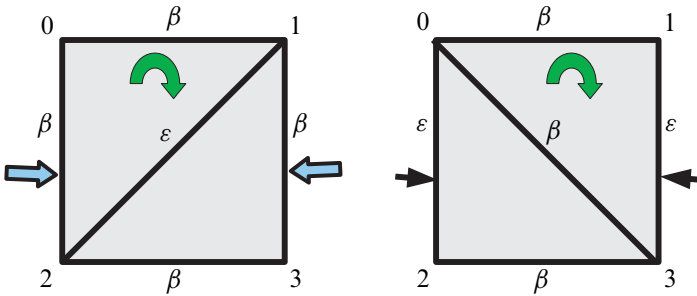

Figure 9: Proof of the identity $\varphi_\beta|_{V_\beta} = \text{id}_{V_\beta}$

The equality $\varphi_\beta(1_V) = 1_V$ follows from the fact that the X -disk obtained by gluing the X -disk B to the bottom of $C_{-+}(\varepsilon, \beta)$ is h-equivalent to B .

To prove the identity (7), consider the X -surfaces (disks with two holes) in Figure 10 (we omit in the figure the collar rectangles glued to some external edges; they play no role in the argument and the reader may easily recover them). The first X -surface is obtained by gluing the X -annulus $C'(\alpha, \beta)$ to the right bottom boundary component (S^1, u_α) of $D(\beta, \alpha)$. Since $\kappa(\varepsilon, \beta, \alpha) = 1$, this X -surface is h-equivalent to the second X -surface in Figure 10. The third X -surface is obtained from the second one by separating the left face along the ε -labeled edge v_0v_2 and gluing it on the

right along the edges indicated by the external arrows. Thus, the second and third X -surfaces are h-homeomorphic. The map from the third X -surface to X can be easily computed because its restriction to the face $v_1 v_3 v_4$ (respectively to $v_0 v_2 v_4$) is the constant homotopy of β to itself (respectively, of $\beta\alpha$ to itself). This X -surface is h-equivalent to $D(\beta\alpha\beta^{-1}, \beta)$. Applying τ , we obtain $v\varphi_\beta^{-1}(w) = wv$ for all $v \in V_\beta$ and $w \in V_{\beta\alpha\beta^{-1}}$. This is an equivalent form of (7).

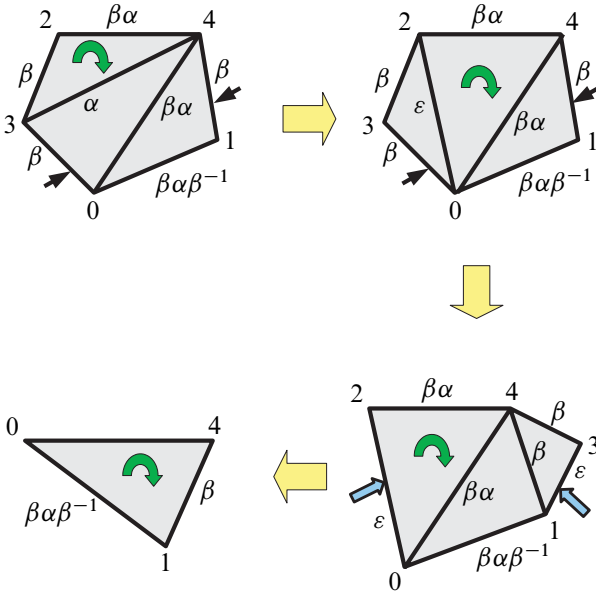

Figure 10: Proof of the identity $v\varphi_\beta^{-1}(w) = wv$

The identity $\eta_\varepsilon(\varphi_\beta(u) \otimes \varphi_\beta(v)) = \eta_\varepsilon(u \otimes v)$ for $u, v \in V_\varepsilon$ follows from the fact that the X -annulus obtained by the gluing of $C_{-+}(\varepsilon, \beta) \amalg C_{-+}^{-1}(\varepsilon, \beta)$ to the bottom of $C_{--}(\varepsilon, \varepsilon)$ is h-equivalent to $C_{--}(\varepsilon, \varepsilon)$ (see Figure 11).

To prove that

$$\varphi_\beta(u) \varphi_\beta(v) = l_{\alpha, \gamma}^\beta \varphi_\beta(uv)$$

for all $u \in V_\alpha$ and $v \in V_\gamma$, consider the X -disks with three holes W_1, W_2, W_3, W_4 in Figure 12 (again we omit the collar rectangles glued to some external edges). Clearly, the homomorphism $\tau(W_1): V_\alpha \otimes V_\gamma \rightarrow V_{\beta\alpha\gamma\beta^{-1}}$ carries $u \otimes v$ to $\varphi_\beta(u) \varphi_\beta(v)$. The X -surface W_2 differs from W_1 by two adjacent triangles $v_0 v_1' v_5$ and $v_0 v_1'' v_5$ both representing $f_{\beta\alpha\beta^{-1}, \beta\gamma\beta^{-1}}: \Delta_2 \rightarrow X$. These two copies of $f_{\beta\alpha\beta^{-1}, \beta\gamma\beta^{-1}}$ “cancel” each other, and so W_2 is h-equivalent to W_1 . Thus, $\tau(W_2) = \tau(W_1)$. The X -surface W_3 is obtained from W_2 by removing the vertices v_1' and v_1'' . Hence

$$\tau(W_3) = \kappa(\beta\alpha\beta^{-1}, \beta\gamma\beta^{-1}, \beta)^{-1} \kappa(\beta\alpha\beta^{-1}, \beta, \gamma) \tau(W_2).$$

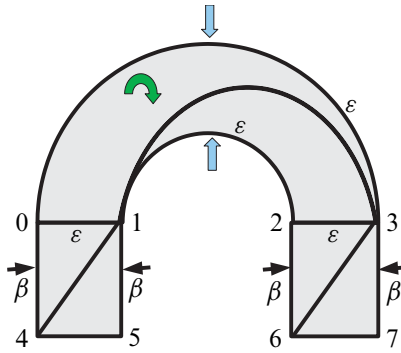

Figure 11: Proof of the identity $\eta_\varepsilon(\varphi_\beta(u) \otimes \varphi_\beta(v)) = \eta_\varepsilon(u \otimes v)$

The X -surface W_4 is obtained from W_3 by switching the diagonal in the quadrilateral $v_0v_3v_4v_5$. Therefore $\tau(W_4) = \kappa(\beta, \alpha, \gamma)^{-1} \tau(W_3)$. Combining these formulas, we obtain $\tau(W_4) = (l_{\alpha, \gamma}^\beta)^{-1} \tau(W_1)$. It remains to observe that the homomorphism $\tau(W_4): V_\alpha \otimes V_\gamma \rightarrow V_{\beta\alpha\gamma\beta^{-1}}$ carries $u \otimes v$ to $\varphi_\beta(uv)$.

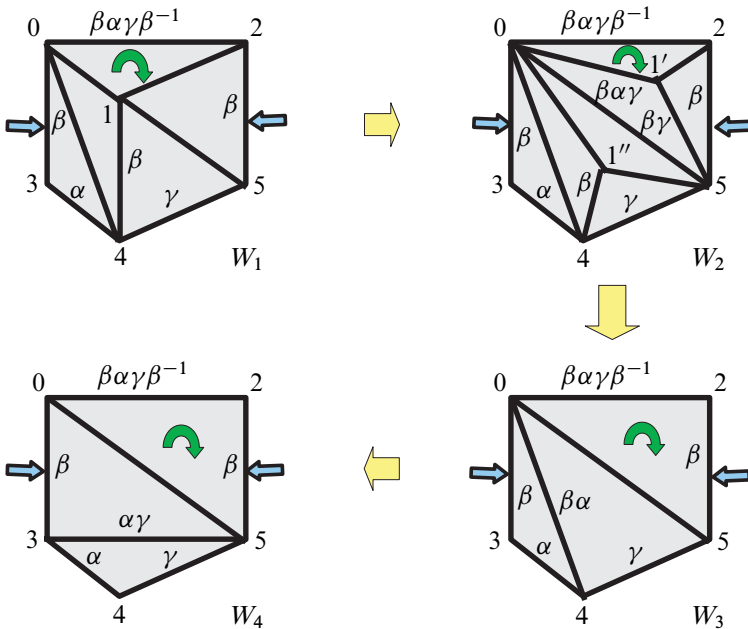

Figure 12: Proof of the identity $\varphi_\beta(u) \varphi_\beta(v) = l_{\alpha, \gamma}^\beta \varphi_\beta(uv)$

To show the identity $\varphi_{\gamma\beta}|_{V_\alpha} = h_{\gamma, \beta}^\alpha \varphi_\gamma \varphi_\beta|_{V_\alpha}$, consider the X -annuli W_1, W_2, W_3, W_4 in Figure 13. Clearly, $W_1 = C_{-+}(\alpha, \gamma\beta)$ and therefore $\tau(W_1) = \varphi_{\gamma\beta}|_{V_\alpha}$. The

X -annulus W_2 is obtained from W_1 by adding two vertices v_2 and v_3 . Hence

$$\tau(W_2) = \kappa(\gamma\beta\alpha\beta^{-1}\gamma^{-1}, \gamma, \beta)^{-1} \kappa(\gamma, \beta, \alpha)^{-1} \tau(W_1).$$

The X -annulus W_3 is obtained from W_2 by switching the diagonal in the quadrilateral $v_0v_2v_5v_3$. Therefore $\tau(W_3) = \kappa(\gamma, \beta\alpha\beta^{-1}, \beta) \tau(W_2)$. Finally, W_4 is obtained from W_3 by canceling two adjacent copies of the singular triangle $f_{\gamma,\beta}$. Therefore W_4 is hom-equivalent to W_3 and $\tau(W_4) = \tau(W_3)$. It is clear that $\tau(W_4) = \varphi_\gamma\varphi_\beta|_{V_\alpha}$. Combining these equalities, we obtain the required identity.

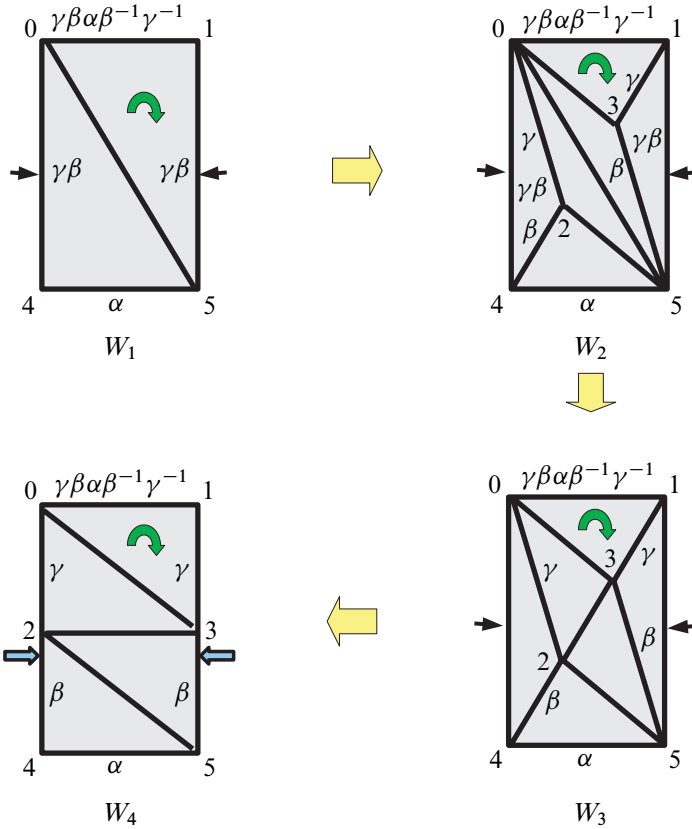

Figure 13: Proof of the identity $\varphi_{\gamma\beta}(u) = h_{\gamma,\beta}^\alpha \varphi_\gamma(\varphi_\beta(u))$

Step 5 (The trace condition) Consider the three X -surfaces (punctured tori) W_1, W_2, W_3 in Figure 14. All three are X -cobordisms between (S^1, u_γ) and \emptyset , where $\gamma = \alpha\beta\alpha^{-1}\beta^{-1}$. Clearly,

$$\tau(W_1) = \kappa(\gamma, \beta\alpha\beta^{-1}, \beta) \tau(W_2) \quad \text{and} \quad \tau(W_3) = \kappa(\gamma, \beta, \alpha) \tau(W_2).$$

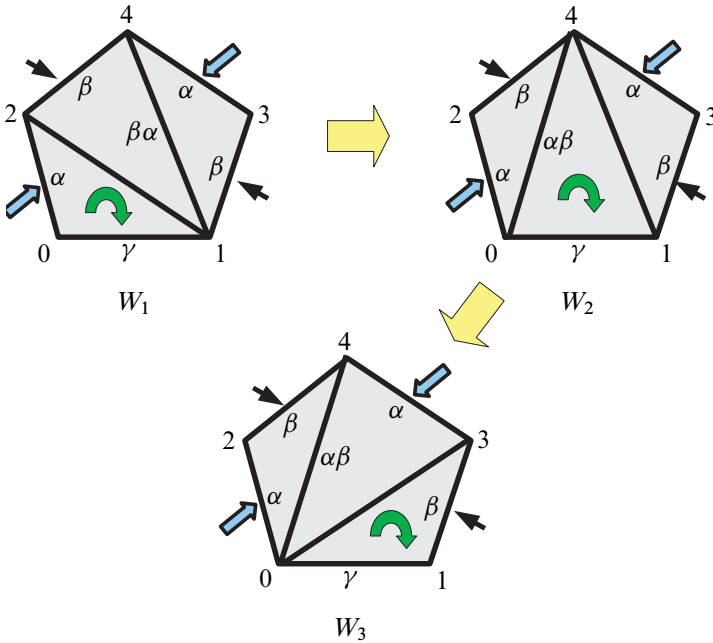

Figure 14: Proof of the trace condition

Consider the X -surface obtained by gluing $C_{-+}(\alpha, \beta)$ and $D(\alpha, \gamma)$. If we identify the two copies of (S^1, u_α) we obtain W_1 . Similarly for the X -surface obtained by gluing $D(\gamma, \beta)$ and $C'(\beta, \alpha)$ we can identify the two copies of (S^1, u_β) in order to obtain W_3 . This implies the equality

$$\text{Tr}(\kappa(\gamma, \beta, \alpha)\mu_c\varphi_\beta: V_\alpha \rightarrow V_\alpha) = \text{Tr}(\kappa(\gamma, \beta\alpha\beta^{-1}, \beta)\varphi_\alpha^{-1}\mu_c: V_\beta \rightarrow V_\beta).$$

We summarize the results above in the following theorem.

Theorem 3.1 *To every 2-dimensional X -HQFT (V, τ) and to every basic system of loops and triangles $\Omega = (\{u_\alpha\}_{\alpha \in G}, \{f_{\alpha, \beta}\}_{\alpha, \beta \in G})$ in X , we associate a TF-algebra $V^\Omega = V^\Omega(\tau)$ over the triple $(G = \pi_1(X), A = \pi_2(X), \kappa^\Omega: G^3 \rightarrow A)$.*

It is obvious that the construction of V^Ω is functorial with respect to isomorphisms of X -HQFTs. We now show that V^Ω does not depend on Ω at least up to coboundary equivalence (see Section 1.4).

Lemma 3.2 *The TF-algebra V^Ω considered up to coboundary equivalence does not depend on the choice of Ω .*

Proof Let $\Omega' = (\{u'_\alpha\}_{\alpha \in G}, \{f'_{\alpha,\beta}\}_{\alpha,\beta \in G})$ be another basic system of loops and triangles in X . Assume first that $u_\alpha = u'_\alpha$ for all $\alpha \in G$. It is clear that up to homotopy constant on $\partial\Delta^2$ the map $f_{\alpha,\beta}: \Delta^2 \rightarrow X$ is a connected sum of $f'_{\alpha,\beta}: \Delta^2 \rightarrow X$ and a certain map $\omega(\alpha, \beta): \Delta^2 \rightarrow X$ carrying $\partial\Delta^2$ to x_0 . Assigning to each pair $(\alpha, \beta) \in G^2$ the element of $A = \pi_2(X, x_0)$ represented by $\omega(\alpha, \beta)$, we obtain a 2–cochain $\omega: G^2 \rightarrow A$. This cochain is normalized because by the definition of a basic system of loops and triangles, $f'_{\alpha,\varepsilon} = f_{\alpha,\varepsilon}$ and $f'_{\varepsilon,\alpha} = f_{\varepsilon,\alpha}$ for all $\alpha \in G$. A direct comparison of the X –surfaces used to define the 3–cocycles $\kappa, \kappa': G^3 \rightarrow A$ associated with Ω, Ω' and the TF–algebras $V^\Omega, V^{\Omega'}$ shows that $\kappa' = \delta^2(\omega)\kappa$ and $V^{\Omega'}$ is obtained from V^Ω by the coboundary transformation determined by ω , ie, $V^{\Omega'} \cong (V^\Omega)^\omega$.

In the case $u_\alpha \neq u'_\alpha$ for some α , we construct a third basic system of loops and triangles in X as follows. For each $\alpha \in G$, fix a homotopy $h_\alpha: S^1 \times [0, 1] \rightarrow X$ between the loops $u_\alpha, u'_\alpha: S^1 \rightarrow X$ representing α . (It is understood that h_ε is a constant map to x_0 .) Recall the map $p: [0, 1] \rightarrow S^1$ from Section 2.2. The map

$$\bar{h}_\alpha = h_\alpha \circ (p \times \text{id}_{[0,1]}): [0, 1]^2 \rightarrow X$$

is a homotopy between $u_\alpha p$ and $u'_\alpha p$. We construct a map $f^h_{\alpha,\beta}: \Delta^2 \rightarrow X$ by gluing $\bar{h}_\alpha, \bar{h}_\beta, \bar{h}_{\alpha\beta}$ to the sides of the singular simplex $f_{\alpha,\beta}: \Delta^2 \rightarrow X$. The system $\Omega^h = (\{u'_\alpha\}_{\alpha \in G}, \{f^h_{\alpha,\beta}\}_{\alpha,\beta \in G})$ satisfies all conditions of a basic system of loops and triangles in X except possibly one: the maps $f^h_{\varepsilon,\alpha}$ and $f^h_{\alpha,\varepsilon}$ are not necessarily the standard “constant” homotopies between two copies of $u'_\alpha p$. However, $f^h_{\varepsilon,\alpha}$ and $f^h_{\alpha,\varepsilon}$ are homotopic rel $\partial\Delta^2$ to these constant homotopies, as easily follows from the assumptions on $f_{\varepsilon,\alpha}$ and $f_{\alpha,\varepsilon}$ and the definition of f^h . Therefore, deforming if necessary the maps $f^h_{\varepsilon,\alpha}$ and $f^h_{\alpha,\varepsilon}$, we can transform Ω^h into a basic system Ω'' of loops and triangles in X . The associated 3–cocycle $\kappa'': G^3 \rightarrow A$ is equal to κ . Moreover, the homomorphisms

$$\{\tau(h_\alpha): V_{u_\alpha} \rightarrow V_{u'_\alpha}\}_{\alpha \in G}$$

form an isomorphism $V^\Omega \rightarrow V^{\Omega''}$ in the category of TF–algebras over (G, A, κ) . By the argument above, the TF–algebra $V^{\Omega'}$ is obtained from $V^{\Omega''}$ by a coboundary transformation. This completes the proof of the lemma. \square

The following theorem shows that the isomorphism class of a 2–dimensional X –HQFT is entirely determined by the underlying TF–algebra.

Theorem 3.3 *Two 2–dimensional X –HQFTs are isomorphic if and only if their underlying TF–algebras are coboundary equivalent.*

Proof We fix a basic system Ω of loops and triangles in X . It is obvious that an isomorphism of X -HQFTs $\rho: (V_1, \tau_1) \rightarrow (V_2, \tau_2)$ induces an isomorphism $V_1^\Omega \simeq V_2^\Omega$ of TF-algebras over $(\pi_1(X), \pi_2(X), \kappa^\Omega)$. Therefore, the underlying TF-algebras are coboundary equivalent.

Conversely, assume that we have two X -HQFTs (V_1, τ_1) and (V_2, τ_2) such that their underlying TF-algebras are coboundary equivalent. If we use the same basic system $\Omega = (\{u_\alpha\}_{\alpha \in \pi_1(X)}, \{f_{\alpha,\beta}\}_{\alpha,\beta \in \pi_1(X)})$ of loops and triangles in X , then the two algebras in question are TF-algebras over the same triple $(\pi_1(X), \pi_2(X), \kappa^\Omega)$. Since they are coboundary equivalent, there is an isomorphism $\rho: V_1^\Omega \rightarrow V_2^\Omega$. We lift ρ to an isomorphism of the HQFTs. For every $\alpha \in \pi_1(X)$, denote by ρ_α the restriction of ρ to $(V_1^\Omega)_\alpha = (V_1)_{(S^1, u_\alpha)}$. For every connected X -curve (M, g_M) , there are $\alpha \in \pi_1(X)$, an X -annuli $a = a_M: [0, 1] \times S^1 \rightarrow X$, and an X -homeomorphism $h = h_M: (S^1, a_M|_{1 \times S^1}) \rightarrow (M, g_M)$ such that

$$a_M|_{0 \times S^1} = u_\alpha: S^1 \rightarrow X \quad \text{and} \quad a_M([0, 1] \times \{*\}) = x_0,$$

where $*$ is the base point of S^1 and x_0 is the base point of X . Notice that α is uniquely determined by (M, g_M) . We define $\rho_M: (V_1)_M \rightarrow (V_2)_M$ by the formula

$$\rho_M = h_{\#_2} \tau_2(a) \rho_\alpha \tau_1(a)^{-1} h_{\#_1}^{-1},$$

where $h_{\#_i}: (V_i)_{(S^1, a|_{1 \times S^1})} \rightarrow (V_i)_{(M, g_M)}$ is the K -isomorphism associated to h by the HQFT (V_i, τ_i) . Next we show that ρ_M does not depend on the choice of a and h . Indeed, take another pair \hat{a}, \hat{h} which satisfies the above properties. Consider a (respectively \hat{a}) as an X -cobordism between (S^1, u_α) and $(S^1, a|_{1 \times S^1})$ (respectively $(S^1, \hat{a}|_{1 \times S^1})$) and observe that $\hat{h}^{-1}h$ is an X -homeomorphism between the top bases of these X -cobordisms. Let C be the X -cobordism obtained by gluing these two along $\hat{h}^{-1}h$ (the orientation in the second cobordism should be reversed). Then C is a cobordism between two copies of (S^1, u_α) . Clearly, C is the trivial X -annuli (as in Axiom (7) of an HQFT) up to h -equivalence and the action of some $c \in \pi_2(X)$. Hence $\tau_i(C): (V_i^\Omega)_\alpha \rightarrow (V_i^\Omega)_\alpha$ is multiplication by c . Since ρ is an isomorphism of TF-algebras, we have

$$\rho_\alpha \tau_1(C) = \tau_2(C) \rho_\alpha$$

or equivalently

$$\rho_\alpha \tau_1(\hat{a})^{-1} (\hat{h}^{-1}h)_{\#_1} \tau_1(a) = \tau_2(\hat{a})^{-1} (\hat{h}^{-1}h)_{\#_2} \tau_2(a) \rho_\alpha.$$

This implies that

$$\hat{h}_{\#_2} \tau_2(\hat{a}) \rho_\alpha \tau_1(\hat{a})^{-1} \hat{h}_{\#_1}^{-1} = h_{\#_2} \tau_2(a) \rho_\alpha \tau_1(a)^{-1} h_{\#_1}^{-1}.$$

So ρ_M does not depend on the choice of a and h . Denote by $\bar{\rho}$ the family of K –isomorphisms $\{\rho_M: (V_1)_M \rightarrow (V_2)_M\}_M$ where M runs over all X –curves. We claim that $\bar{\rho}$ is an isomorphism of HQFTs.

For any X –homeomorphism $f: M \rightarrow N$, we have

$$\begin{aligned} f_{\#_2} \rho_M &= f_{\#_2} (h_M)_{\#_2} \tau_2(a_M) \rho_\alpha \tau_1(a_M)^{-1} (h_M)_{\#_1}^{-1} \\ &= (f \circ h_M)_{\#_2} \tau_2(a_M) \rho_\alpha \tau_1(a_M)^{-1} (f \circ h_M)_{\#_1}^{-1} f_{\#_1} \\ &= \rho_N f_{\#_1}. \end{aligned}$$

So, $\bar{\rho}$ is natural with respect to X –homeomorphisms.

Next, notice that any compact oriented X –surface splits along a finite family of disjoint simple loops into a disjoint union of X –disks with at most two holes. Deforming if necessary the map from the surface to X , we can choose the splitting loops to be X –curves X –homeomorphic to (S^1, u_α) , for some $\alpha \in \pi_1(X)$. Moreover, we can make the cuts in such a way that each component adjacent to the boundary is X –homeomorphic to some a_M and all the other X –surfaces are of types

$$(14) \quad B, \quad S(\alpha, a), \quad D(\alpha, \beta), \quad C_{-+}(\alpha, \beta), \quad C_{--}(\varepsilon, \varepsilon), \quad C_{++}(\varepsilon, \varepsilon).$$

We consider the X –surface $a_M(\text{id} \times h_M^{-1}): [0, 1] \times M \rightarrow X$ which is an X –cobordism between $M' = (M, u_\alpha \circ h_M^{-1})$ and (M, g_M) . Axiom (4) of an HQFT implies that for $i = 1, 2$,

$$\tau_i(a_M(\text{id} \times h_M^{-1})) = (h_M)_{\#_i} \tau_i(a_M) (h_M)_{\#_i}^{-1}.$$

From this formula and the definition of $\bar{\rho}$, we have

$$\begin{aligned} \rho_M \tau_1(a_M(\text{id} \times h_M^{-1})) &= (h_M)_{\#_2} \tau_2(a_M) \rho_\alpha (h_M)_{\#_1}^{-1} \\ &= (h_M)_{\#_2} \tau_2(a_M) (h_M)_{\#_2}^{-1} (h_M)_{\#_2} \rho_\alpha (h_M)_{\#_1}^{-1} \\ &= \tau_2(a_M(\text{id} \times h_M^{-1})) \rho_{M'}. \end{aligned}$$

Therefore the natural square diagram associated to $\bar{\rho}$ and $a_M(\text{id} \times h_M^{-1})$ is commutative. Since ρ is a morphism of TF–algebras, the natural square diagrams associated with the X –surfaces listed in (14) are commutative. Finally, since any X –surface can be obtained by gluing a finite collection of the above X –surfaces along X –homeomorphisms, we get that the natural square diagrams associated to all X –surfaces are commutative. We conclude that $\bar{\rho}$ is an isomorphism of HQFTs. □

We expect that any TF–algebra can be realized by a 2–dimensional HQFT which if true, together with [Theorem 3.3](#) would yield a complete algebraic characterization of 2–dimensional HQFTs with arbitrary targets.

Given a mapping of pointed topological spaces $f: Y \rightarrow X$, we can pull back a 2-dimensional X -HQFT along f to obtain a 2-dimensional Y -HQFT. If f induces isomorphisms in π_1 and π_2 , then the underlying TF-algebra of this Y -HQFT is isomorphic to the underlying TF-algebra of the original X -HQFT.

4 Simple TF-algebras and cohomological HQFTs

In this section we compute the underlying TF-algebras of the cohomological 2-dimensional HQFTs. We begin by introducing a class of simple TF-algebras.

4.1 Simple TF-algebras and κ -pairs

Let G be a group with neutral element ε and A be a left G -module. Let $\kappa: G^3 \rightarrow A$ be a normalized 3-cocycle. A TF-algebra $V = \bigoplus_{\alpha \in G} V_\alpha$ over (G, A, κ) is *simple* if $\dim_K(V_\alpha) = 1$ for all $\alpha \in G$. We now classify simple TF-algebras in terms of so-called κ -pairs.

From now on we endow the multiplicative abelian group K^* with the trivial action of G . This allows us to apply notation of Section 1.1 to K^* -valued cochains on G . By a κ -pair, we mean a pair of maps $g_1: G \times G \rightarrow K^*$, $g_2: A \rightarrow K^*$ such that g_2 is a $\mathbb{Z}[G]$ -homomorphism,

$$(15) \quad g_1(\alpha, \varepsilon) = g_1(\varepsilon, \alpha) = 1 \quad \text{for all } \alpha \in G,$$

$$(16) \quad \delta^2(g_1) = g_2 \circ \kappa: G^3 \rightarrow K^*.$$

The $\mathbb{Z}[G]$ -linearity of $g_2: A \rightarrow K^*$ means that g_2 is a group homomorphism such that for all $\alpha \in G$, $a \in A$,

$$(17) \quad g_2({}^\alpha a) = g_2(a).$$

For example, for any map $\psi: G \rightarrow K^*$ the pair

$$(g_1 = \delta^1(\psi): G \times G \rightarrow K^*, g_2 = 1: A \rightarrow K^*)$$

is a κ -pair. We call it a *coboundary κ -pair*.

Lemma 4.1 *Let (g_1, g_2) be a κ -pair. For each $\alpha \in G$, let V_α be the one-dimensional vector space over K with basis vector l_α . We provide $V = \bigoplus_{\alpha \in G} V_\alpha$ with a structure of an A -module by $av = g_2(a)v$ for all $v \in V$. We provide V with K -bilinear multiplication by*

$$(18) \quad l_\alpha l_\beta = g_1(\alpha, \beta)^{-1} l_{\alpha\beta}$$

for all $\alpha, \beta \in G$. Let $\eta_\varepsilon: V_\varepsilon \otimes V_\varepsilon \rightarrow K$ be the K –bilinear form such that

$$(19) \quad \eta_\varepsilon(l_\varepsilon \otimes l_\varepsilon) = g_1(\varepsilon, \varepsilon).$$

Let $\varphi_\beta: V \rightarrow V$ be the K –homomorphism defined by

$$(20) \quad \varphi_\beta(l_\alpha) = g_1(\beta, \alpha)^{-1} g_1(\beta\alpha\beta^{-1}, \beta) l_{\beta\alpha\beta^{-1}}$$

for all $\alpha, \beta \in G$. Then the G –graded vector space V with this data is a TF–algebra over (G, A, κ) .

The TF–algebra constructed in this lemma is denoted by $V(g_1, g_2)$.

Proof The $K[A]$ –bilinearity of multiplication in V follows from the definitions. Formula (1) follows from the identity (17). It is sufficient to verify (2) for the basis vectors $u = l_\alpha, v = l_\beta, w = l_\gamma$:

$$\begin{aligned} (l_\alpha l_\beta) l_\gamma &= (g_1(\alpha, \beta)^{-1} l_{\alpha\beta}) l_\gamma \\ &= g_1(\alpha, \beta)^{-1} g_1(\alpha\beta, \gamma)^{-1} l_{\alpha\beta\gamma} \\ &= g_1(\beta, \gamma)^{-1} g_1(\alpha, \beta\gamma)^{-1} g_2(\kappa(\alpha, \beta, \gamma)) l_{\alpha\beta\gamma} \\ &= g_2(\kappa(\alpha, \beta, \gamma)) l_\alpha (l_\beta l_\gamma) \\ &= \kappa(\alpha, \beta, \gamma) l_\alpha (l_\beta l_\gamma). \end{aligned}$$

Formula (15) implies that l_ε is the unit element of V . The symmetry and nondegeneracy of η_ε are obvious. The nondegeneracy of the form $\eta_\alpha: V_\alpha \otimes V_{\alpha^{-1}} \rightarrow K$ defined by (3) follows from the formula $\eta(l_\alpha \otimes l_{\alpha^{-1}}) = g_1(\alpha, \alpha^{-1})^{-1}$. We check (4):

$$\begin{aligned} \varphi_\beta(al_\alpha) &= g_1(\beta, \alpha)^{-1} g_1(\beta\alpha\beta^{-1}, \beta) g_2(a) l_{\beta\alpha\beta^{-1}} \\ &= g_2(\beta a) g_1(\beta, \alpha)^{-1} g_1(\beta\alpha\beta^{-1}, \beta) l_{\beta\alpha\beta^{-1}} \\ &= \beta a \varphi_\beta(l_\alpha). \end{aligned}$$

Formulas (5) and (6) follow from the definitions. We check (7):

$$\begin{aligned} \varphi_\beta(l_\alpha) l_\beta &= g_1(\beta, \alpha)^{-1} g_1(\beta\alpha\beta^{-1}, \beta) l_{\beta\alpha\beta^{-1}} l_\beta \\ &= g_1(\beta, \alpha)^{-1} l_{\beta\alpha} = l_\beta l_\alpha. \end{aligned}$$

Similar computations prove (8) and (9). We now check (10). Observe that for $\alpha, \beta, \gamma \in G$,

$$\begin{aligned} \varphi_\gamma(\varphi_\beta(l_\alpha)) &= g_1(\gamma, \beta\alpha\beta^{-1})^{-1} g_1(\gamma\beta\alpha(\gamma\beta)^{-1}, \gamma) g_1(\beta, \alpha)^{-1} g_1(\beta\alpha\beta^{-1}, \beta) l_{\gamma\beta\alpha(\gamma\beta)^{-1}} \\ \varphi_\gamma\beta(l_\alpha) &= g_1(\gamma\beta, \alpha)^{-1} g_1(\gamma\beta\alpha(\gamma\beta)^{-1}, \gamma\beta) l_{\gamma\beta\alpha(\gamma\beta)^{-1}}. \end{aligned}$$

Therefore $\varphi_{\gamma\beta}(l_\alpha) = h \varphi_\gamma(\varphi_\beta(l_\alpha))$, where

$$h = g_1(\gamma\beta, \alpha)^{-1} g_1(\gamma\beta\alpha(\gamma\beta)^{-1}, \gamma\beta) \times g_1(\gamma, \beta\alpha\beta^{-1}) g_1(\gamma\beta\alpha(\gamma\beta)^{-1}, \gamma)^{-1} g_1(\beta, \alpha) g_1(\beta\alpha\beta^{-1}, \beta)^{-1}.$$

Now, a direct computation using the definition of $h_{\gamma,\beta}^\alpha$ and the assumption that g_2 is a group homomorphism satisfying $g_2 \circ \kappa = \delta^2(g_1)$ shows that $g_2(h_{\gamma,\beta}^\alpha) = h$. Therefore

$$\varphi_{\gamma\beta}(l_\alpha) = h \varphi_\gamma(\varphi_\beta(l_\alpha)) = h_{\gamma,\beta}^\alpha \varphi_\gamma(\varphi_\beta(l_\alpha)).$$

To check the trace identity (11), observe that

$$\begin{aligned} &g_2(\kappa(\alpha\beta\alpha^{-1}\beta^{-1}, \beta, \alpha)) \\ &= (\delta^2(g_1))(\alpha\beta\alpha^{-1}\beta^{-1}, \beta, \alpha) \\ &= g_1(\beta, \alpha) g_1(\alpha\beta\alpha^{-1}, \alpha)^{-1} g_1(\alpha\beta\alpha^{-1}\beta^{-1}, \beta\alpha) g_1(\alpha\beta\alpha^{-1}\beta^{-1}, \beta)^{-1} \end{aligned}$$

and similarly

$$\begin{aligned} &g_2(\kappa(\alpha\beta\alpha^{-1}\beta^{-1}, \beta\alpha\beta^{-1}, \beta)) \\ &= (\delta^2(g_1))(\alpha\beta\alpha^{-1}\beta^{-1}, \beta\alpha\beta^{-1}, \beta) \\ &= g_1(\beta\alpha\beta^{-1}, \beta) g_1(\alpha, \beta)^{-1} g_1(\alpha\beta\alpha^{-1}\beta^{-1}, \beta\alpha) g_1(\alpha\beta\alpha^{-1}\beta^{-1}, \beta\alpha\beta^{-1})^{-1}. \end{aligned}$$

It follows from the definitions that

$$\begin{aligned} \text{Tr}(\mu_c \varphi_\beta) &= g_1(\beta, \alpha)^{-1} g_1(\beta\alpha^{-1}\beta^{-1}, \beta) g_1(\alpha\beta\alpha^{-1}\beta^{-1}, \beta\alpha^{-1}\beta^{-1})^{-1}, \\ \text{Tr}(\varphi_\alpha^{-1} \mu_c) &= g_1(\alpha\beta\alpha^{-1}, \alpha)^{-1} g_1(\alpha, \beta) g_1(\alpha\beta\alpha^{-1}\beta^{-1}, \beta)^{-1}. \end{aligned}$$

Comparing these expressions, we obtain that

$$g_2(\kappa(\alpha\beta\alpha^{-1}\beta^{-1}, \beta, \alpha)) \text{Tr}(\mu_c \varphi_\beta) = g_2(\kappa(\alpha\beta\alpha^{-1}\beta^{-1}, \beta\alpha\beta^{-1}, \beta)) \text{Tr}(\varphi_\alpha^{-1} \mu_c).$$

This formula is equivalent to (11). □

Lemma 4.2 Any simple TF-algebra $V = \bigoplus_{\alpha \in G} V_\alpha$ over (G, A, κ) that satisfies $\eta_\varepsilon(1_V \otimes 1_V) = 1$ is isomorphic to $V(g_1, g_2)$ for a certain κ -pair (g_1, g_2) . This κ -pair is determined by V uniquely up to multiplication of g_1 by $\delta^1(\psi)$ for a map $\psi: G \rightarrow K^*$.

Proof For each $\alpha \in G$, fix a nonzero vector $l_\alpha \in V_\alpha$. In the role of $l_\varepsilon \in V_\varepsilon$ we take 1_V . For any $a \in A$ and $\alpha \in G$, we have $al_\alpha = g_2^\alpha(a)l_\alpha$ with $g_2^\alpha(a) \in K$. Clearly,

$$l_\alpha = 1_A l_\alpha = (a^{-1}a)l_\alpha = g_2^\alpha(a^{-1})g_2^\alpha(a)l_\alpha$$

and so $g_2^\alpha(a) \in K^*$.

Given $\alpha, \beta \in G$, we have $l_\alpha l_\beta = c(\alpha, \beta) l_{\alpha\beta}$ for some $c(\alpha, \beta) \in K$. Since the pairing (3) is nondegenerate, $l_\alpha l_{\alpha^{-1}} \neq 0$. Thus, $c(\alpha, \alpha^{-1}) \neq 0$ for all α .

We claim that $g_2^\alpha(a)$ does not depend on α for every $a \in A$. Indeed,

$$\begin{aligned} (al_\alpha)l_{\alpha^{-1}} &= g_2^\alpha(a)l_\alpha l_{\alpha^{-1}} = g_2^\alpha(a)c(\alpha, \alpha^{-1})l_\varepsilon, \\ a(l_\alpha l_{\alpha^{-1}}) &= ac(\alpha, \alpha^{-1})l_\varepsilon = g_2^\varepsilon(a)c(\alpha, \alpha^{-1})l_\varepsilon. \end{aligned}$$

Since $(al_\alpha)l_{\alpha^{-1}} = a(l_\alpha l_{\alpha^{-1}})$ and $c(\alpha, \alpha^{-1}) \neq 0$, we have $g_2^\alpha(a) = g_2^\varepsilon(a)$. Set $g_2 = g_2^\varepsilon: A \rightarrow K^*$. Since V is an A -module, the map g_2 is a group homomorphism. Formula (1) implies the identity (17).

Given $\alpha, \beta \in G$, we have

$$\begin{aligned} c(\beta, \beta^{-1})l_\alpha &= c(\beta, \beta^{-1})l_\alpha l_\varepsilon \\ &= l_\alpha(l_\beta l_{\beta^{-1}}) \\ &= \kappa(\alpha, \beta, \beta^{-1})^{-1}(l_\alpha l_\beta)l_{\beta^{-1}} \\ &= \kappa(\alpha, \beta, \beta^{-1})^{-1}c(\alpha, \beta)l_{\alpha\beta}l_{\beta^{-1}}. \end{aligned}$$

Therefore $c(\alpha, \beta) \in K^*$. Let $g_1: G \times G \rightarrow K^*$ be the map defined by $g_1(\alpha, \beta) = (c(\alpha, \beta))^{-1}$ for all α, β . The identity $l_\alpha l_\beta = g_1(\alpha, \beta)^{-1}l_{\alpha\beta}$ and Formula (2) yield

$$g_1(\alpha, \beta)^{-1}g_1(\alpha\beta, \gamma)^{-1}l_{\alpha\beta\gamma} = g_2(\kappa(\alpha, \beta, \gamma))g_1(\alpha, \beta\gamma)^{-1}g_1(\beta, \gamma)^{-1}l_{\alpha\beta\gamma}.$$

This implies that $g_2 \circ \kappa = \delta^2(g_1)$. The equality (15) follows from the definitions and the choice $l_\varepsilon = 1_V$. Thus, the maps g_1, g_2 form a κ -pair. It is clear that $V = V(g_1, g_2)$.

The second claim of the lemma follows from the fact that any two bases $l = \{l_\alpha\}_{\alpha \in G}$ and $l' = \{l'_\alpha\}_{\alpha \in G}$ in V as above are related by $l_\alpha = \psi_\alpha l'_\alpha$, where $\psi_\alpha \in K^*$ for all α . The bases l, l' yield the same map $g_2: A \rightarrow K^*$ while the associated maps $g_1: G \times G \rightarrow K^*$ differ by the coboundary of the map $G \rightarrow K^*, \alpha \rightarrow \psi_\alpha$. \square

4.2 The group $H^2(G, A, \kappa; K^*)$

The κ -pairs $(g_1: G \times G \rightarrow K^*, g_2: A \rightarrow K^*)$ form an abelian group $H = H(G, A, \kappa)$ under pointwise multiplication. The neutral element of H is the κ -pair $(g_1 = 1, g_2 = 1)$. The inverse of a κ -pair (g_1, g_2) in H is the κ -pair (g_1^{-1}, g_2^{-1}) . The coboundary κ -pairs form a subgroup of H . Let $H^2(G, A, \kappa; K^*)$ be the quotient of H by the subgroup of coboundary κ -pairs. Lemma 4.2 yields a bijective correspondence between the set $H^2(G, A, \kappa; K^*) \times K^*$ and the set of isomorphism classes of simple TF-algebras over (G, A, κ) . This correspondence assigns to a pair $(h \in H^2(G, A, \kappa; K^*), z \in K^*)$ the isomorphism class of the z -rescaled TF-algebra $V(g_1, g_2)$, where (g_1, g_2) is an

arbitrary κ -pair representing h . The following theorem due to Eilenberg and MacLane computes $H^2(G, A, \kappa; K^*)$ in topological terms.

Theorem 4.3 [3] *Let X be a path connected topological space with base point x_0 . Let $G = \pi_1(X, x_0)$, $A = \pi_2(X, x_0)$, and $\Omega = \{\{u_\alpha\}_{\alpha \in G}; \{f_{\alpha, \beta}\}_{\alpha, \beta \in G}\}$ be a basic system of loops and triangles in X . Let θ be a K^* -valued singular 2-cocycle on X representing a cohomology class $[\theta] \in H^2(X, K^*)$. Then the pair $(g_1: G \times G \rightarrow K^*, g_2: A \rightarrow K^*)$ defined by $g_1(\alpha, \beta) = \theta(f_{\alpha, \beta})$ for $\alpha, \beta \in G$ and $g_2(a) = \theta(a)$ for $a \in A$ is a κ -pair, where $\kappa = \kappa^\Omega: G^3 \rightarrow A$ be the 3-cocycle defined in Section 2.2. Moreover, the formula $[\theta] \mapsto (g_1, g_2)$ defines an isomorphism*

$$H^2(X, K^*) \cong H^2(G, A, \kappa; K^*).$$

4.3 The underlying TF-algebras of cohomological HQFTs

We keep the assumptions of Theorem 4.3.

Theorem 4.4 *Let (V^θ, τ^θ) be the 2-dimensional X -HQFT determined by the cohomology class $\theta \in H^2(X, K^*)$ [5]. If θ corresponds to $(g_1, g_2) \in H^2(G, A, \kappa, K^*)$, then the underlying TF-algebra of (V^θ, τ^θ) is isomorphic to $V(g_1, g_2)$.*

Proof Let $V = \bigoplus_{\alpha \in G} V_\alpha = V^\Omega$ be the underlying TF-algebra of (V^θ, τ^θ) . The definition of V^θ implies that $V_\alpha = V_{(S^1, u_\alpha)}^\theta$ is a 1-dimensional K -vector space. This vector space is generated by a vector p_α represented by the map $p: [0, 1] \rightarrow S^1$ from Section 2.2 viewed as a fundamental cycle of S^1 . Multiplication in V is computed by

$$p_\alpha p_\beta = \tau^\theta(D(\alpha, \beta))(p_\alpha \otimes p_\beta) = f^*(\theta)(B) p_{\alpha\beta},$$

where $\alpha, \beta \in G$, the map $f: D(\alpha, \beta) \rightarrow X$ is determined by the structure of an X -surface in the disk with two holes $D(\alpha, \beta)$, and B is a fundamental singular chain in $D(\alpha, \beta)$ such that $\partial(B) = p_{\alpha\beta} - p_\alpha - p_\beta$. It is easy to see (cf [6]) that

$$g^*(\theta)(B) = \theta(f_{\alpha, \beta})^{-1} = g_1(\alpha, \beta)^{-1}.$$

So, $p_\alpha p_\beta = g_1(\alpha, \beta)^{-1} p_{\alpha\beta}$. Similarly, for all $a \in A = \pi_2(X)$,

$$a p_\varepsilon = \tau^\theta(S(\varepsilon, a))(p_\varepsilon) = \theta(a) p_\varepsilon = g_2(a) p_\varepsilon,$$

where $\theta(a) \in K^*$ is the evaluation of θ on a . Therefore $V = V(g_1, g_2)$. □

References

- [1] **M Atiyah**, *Topological quantum field theories*, Inst. Hautes Études Sci. Publ. Math. (1988) 175–186 (1989) [MR1001453](#)
- [2] **M Brightwell, P Turner**, *Representations of the homotopy surface category of a simply connected space*, J. Knot Theory Ramifications 9 (2000) 855–864 [MR1780591](#)
- [3] **S Eilenberg, S MacLane**, *Determination of the second homology and cohomology groups of a space by means of homotopy invariants*, Proc. Nat. Acad. Sci. U. S. A. 32 (1946) 277–280 [MR0019307](#)
- [4] **T Porter, V Turaev**, *Formal homotopy quantum field theories. I. Formal maps and crossed \mathcal{C} -algebras*, J. Homotopy Relat. Struct. 3 (2008) 113–159 [MR2426178](#)
- [5] **V Turaev**, *Homotopy field theory in dimension 2 and group-algebras* [arXiv: math.QA/9910010](#)
- [6] **V Turaev**, *Homotopy Quantum Field Theory*, EMS Tracts Math. 10, European Math. Soc., Zürich (2010) With appendices by M Müger and A Virelizier

MDS,VT: Department of Mathematics, Indiana University
Rawles Hall, Bloomington IN 47405, United States

MDS: Institute of Mathematics of the Romanian Academy
PO Box 1-764, RO-70700 Bucharest, Romania

mstaic@indiana.edu, vtouraev@indiana.edu

Received: 14 December 2009 Revised: 30 March 2010