

2–associahedra

NATHANIEL BOTTMAN

For any $r \geq 1$ and $\mathbf{n} \in \mathbb{Z}_{\geq 0}^r \setminus \{\mathbf{0}\}$ we construct a poset $W_{\mathbf{n}}$ called a *2–associahedron*. The 2–associahedra arose in symplectic geometry, where they are expected to control maps between Fukaya categories of different symplectic manifolds. We prove that the completion $\widehat{W}_{\mathbf{n}}$ is an abstract polytope of dimension $|\mathbf{n}| + r - 3$. There are forgetful maps $W_{\mathbf{n}} \rightarrow K_r$, where K_r is the $(r-2)$ –dimensional associahedron, and the 2–associahedra specialize to the associahedra (in two ways) and to the multiplihedra. In an appendix, we work out the 2– and 3–dimensional 2–associahedra in detail.

53D37

1 Introduction

Ma’u, Wehrheim and Woodward proposed in [5] that a Lagrangian correspondence

$$M_1 \xrightarrow{L_{12}} M_2$$

between symplectic manifolds should induce an A_{∞} –functor

$$\mathrm{Fuk}(M_1) \xrightarrow{\Phi(L_{12})} \mathrm{Fuk}(M_2)$$

between Fukaya categories, where $\Phi(L_{12})$ is defined by counting pseudoholomorphic quilted disks. In his thesis [2], the author suggested extending this proposal by counting witch balls, which are pseudoholomorphic quilted spheres. The underlying domain moduli spaces (described in Section 1.1) are stratified topological spaces, and the posets indexing the strata have interesting combinatorial structure, similarly to how the Stasheff polytopes have strata indexed by the associahedra. In this paper we define these underlying posets, which we call *2–associahedra*.

In this introduction, we will first motivate the construction of the 2–associahedra by describing some bubbling phenomena in spaces of witch curves, which are the moduli spaces of domains of witch balls. After that, we will give a plan for the body of the paper.

1.1 Motivation for W_n from witch curves

The author was led to define and study the 2–associahedra W_n because they are the posets corresponding to degenerations in the moduli space $\overline{2\mathcal{M}}_n$ of *witch curves*—similarly to how the compactified moduli space of r points on the line modulo translations and dilations is stratified by the associahedron K_r . The moduli space $\overline{2\mathcal{M}}_n$ is defined by the author in [3], crucially relying on the current paper’s construction of W_n . Here we sketch the definition of $\overline{2\mathcal{M}}_n$ to motivate the definition of W_n .

We begin by defining the uncompactified moduli space:

$$(1) \quad 2\mathcal{M}_n := \left\{ \begin{array}{l|l} (x_1, \dots, x_r) \in \mathbb{R}^r & x_1 < \dots < x_r \\ (y_{11}, \dots, y_{1n_1}) \in \mathbb{R}^{n_1} & y_{11} < \dots < y_{1n_1} \\ \vdots & \vdots \\ (y_{r1}, \dots, y_{rn_r}) \in \mathbb{R}^{n_r} & y_{r1} < \dots < y_{rn_r} \end{array} \right\} / \mathbb{R}^2 \rtimes \mathbb{R}_{>0} =: X/G.$$

We view an element of X as describing a configuration of r vertical lines in \mathbb{R}^2 with x –positions x_1, \dots, x_r , along with n_i marked points on the i^{th} line with y –positions y_{i1}, \dots, y_{in_i} . (By identifying $\mathbb{R}^2 \cup \{\infty\} \simeq S^2$, we can also view an element of X as a configuration of marked circles on S^2 , where all the circles intersect tangentially at the south pole.) We view G as the group of affine-linear transformations of the plane which consist of a translation and a positive dilation, which we can extend to define an action of G on X .

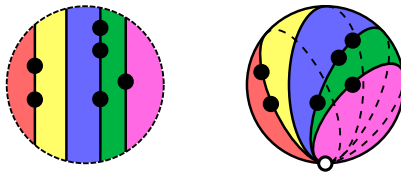

Figure 1: Two views of a witch curve in the main stratum $2\mathcal{M}_n \subset \overline{2\mathcal{M}}_n$: as \mathbb{R}^2 with marked lines (left) and as S^2 with marked circles (right)

The moduli space $2\mathcal{M}_n$ is not compact: points on a single line can collide, or lines can collide, or these two phenomena can take place simultaneously. We compactify $2\mathcal{M}_n$ to $\overline{2\mathcal{M}}_n$ like so: when a collection of lines collide, then wherever the marked points on these lines are as this collision happens, we bubble off another configuration of lines and points. To define $\overline{2\mathcal{M}}_n$ precisely, we need to specify the allowed degenerations, and this is where the 2–associahedra come in: the elements of W_n correspond to the allowed degenerations in $\overline{2\mathcal{M}}_n$. We illustrate this in Figure 2.

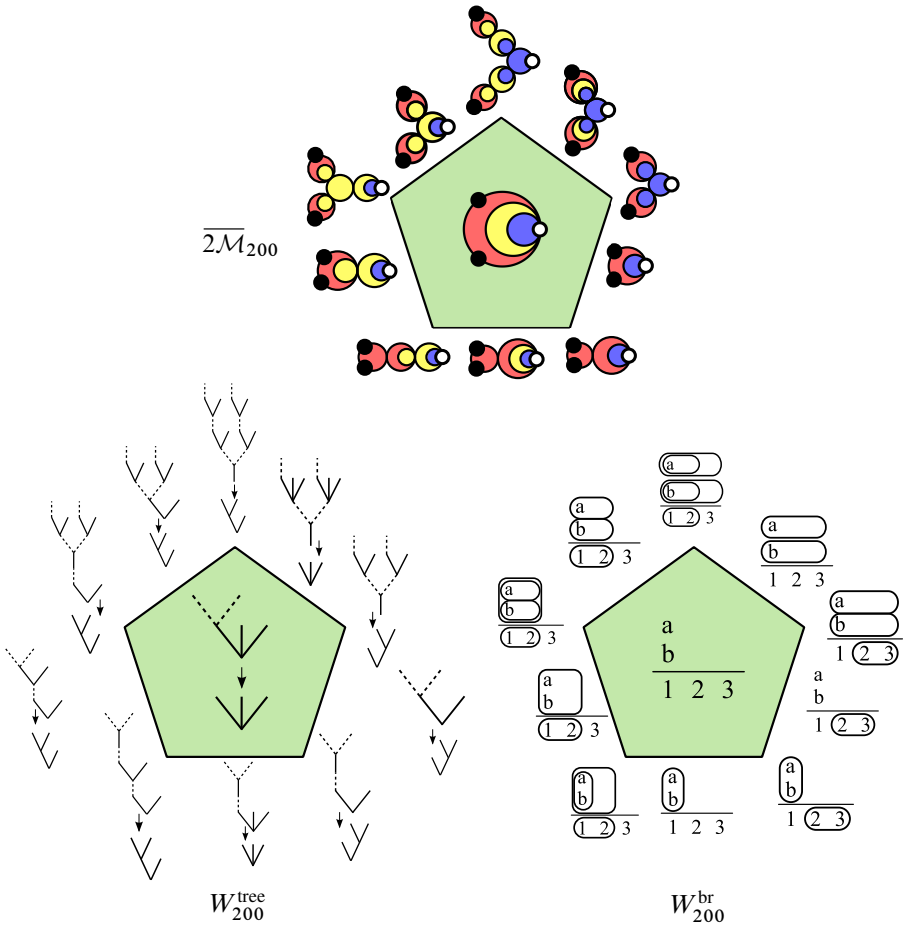
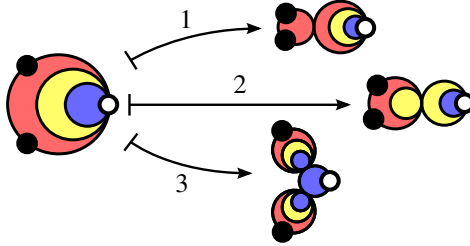

Figure 2: The compactified moduli space $\overline{2\mathcal{M}}_{200}$ (top) and two presentations of W_{200} (bottom)

At the top of Figure 2, we are identifying configurations of lines and points in the plane with configurations of vertical lines in the right half-plane, which can in turn be identified with configurations of circles on a disk, all of which intersect tangentially at a point on the boundary. In this figure, and throughout this paper, we overlay the posets W_{200}^{tree} and W_{200}^{br} over polytopes. The set of faces of any polytope has a poset structure, where $F < G$ if the containment $F \subset G$ holds; our depiction of W_{200}^{tree} and W_{200}^{br} indicates that they are isomorphic to the face poset of the pentagon.

W_n is intended to index the possible degenerations that a sequence of points in the moduli space $\overline{2\mathcal{M}}_n$ can undergo. In Section 3 we will define two models for W_n : we call them W_n^{tree} and W_n^{br} . To approach and motivate these models, consider the

three degenerations in $\overline{2\mathcal{M}}_{200}$ shown in below, corresponding respectively to the bottom, bottom-left and upper-right edges in the depiction of $\overline{2\mathcal{M}}_{200}$ above:



Degeneration 1 occurs when the two black points collide; degeneration 2 occurs when the larger interior circle expands and collides with the boundary circle, while the black points simultaneously collide; and degeneration 3 occurs when the two interior circles simultaneously expand and collide with the boundary circle. To define the 2–associahedra, we must produce combinatorial data that track these degenerations. We can do so in two ways:

- Represent each disk as a vertex in a tree, with solid edges corresponding to the seams (ie boundary circle or interior circles) appearing on that disk. We represent an attachment between two disks as a dashed edge; we also represent a marked point by a dashed edge. This leads to the model W_n^{tree} , and in this model the degenerations pictured above take the following form:

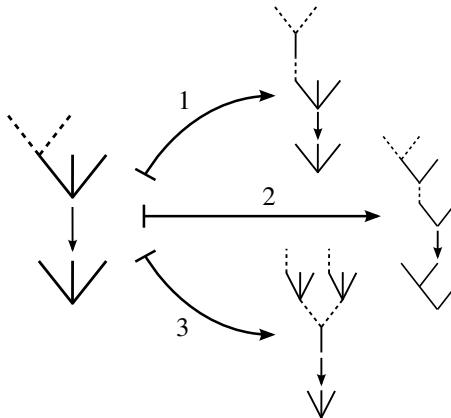

The reader will observe that a single datum is not only a tree with solid and dashed edges, but also a smaller, solid tree which receives a map from the larger tree. The reason for this is that when disks bubble off, the same seam may appear in multiple disks. These seams must remain linked, so that the enlargement $\overline{2\mathcal{M}}_n$ is a reasonable

compactification of $2\mathcal{M}_n$, and this linking is enforced by the smaller tree and the map it receives.

- Represent the seams as a horizontal line of numbers; above each number, represent the points that appear on that seam as a vertical line of letters. For any given disk C in the bubble tree, form a subtree consisting of the disks that can only be reached from the main component by passing through C ; the datum corresponding to C is a grouping including those marked points appearing in this subtree. Such a grouping is called a 2-bracket, and every 2-bracket comes with a “width”, which indicates the seams that appear on the corresponding disk. This leads to the model W_n^{br} , and in this model the above degenerations take the following form:

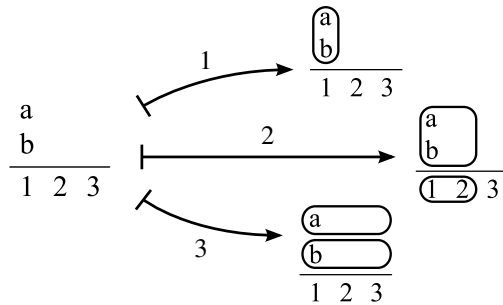

1.2 Plan

The constructions in this paper are rather technical, and with the exception of Section 2, our definitions and results are completely new. For this reason, we give a plan of the paper to orient the reader.

- **Section 2** We recall two equivalent constructions, called K_r^{tree} and K_r^{br} , of the associahedra K_r , along with several basic properties. This material is not new, but these particular constructions of K_r are needed for the constructions of the 2-
associahedron W_n in Section 3. In addition, the constructions of K_r^{tree} and K_r^{br} and the proofs of Propositions 2.13 and 2.14 are analogous to the constructions of W_n^{tree} and W_n^{br} and the proofs of Theorems 3.17 and 4.1, and so will serve as an introduction to Sections 3–4.

- **Section 2.1** In Definition 2.2 and Definition–Lemma 2.9 we define K_r^{tree} , a poset consisting of rooted ribbon trees with r leaves. Then, in Definition 2.11, we define the poset K_r^{br} , consisting of 1-bracketings of r letters. We prove that the posets K_r^{tree} and K_r^{br} are isomorphic in Proposition 2.13, and define $K_r := K_r^{\text{tree}} = K_r^{\text{br}}$.

– **Section 2.2** We establish two important properties of K_r , in the following result:

Proposition 2.14 (key properties of K_r) *The posets (K_r) satisfy the following properties:*

- **ABSTRACT POLYTOPE** For $r \geq 2$, the poset $\hat{K}_r := K_r \cup \{F_{-1}\}$ is an abstract polytope of dimension $r - 2$.
- **RECURSIVE** For any $T \in K_r^{\text{tree}}$, there is an inclusion of posets

$$(2) \quad \gamma_T: \prod_{\alpha \in T_{\text{int}}} K_{\#\text{in}(\alpha)}^{\text{tree}} \hookrightarrow K_r^{\text{tree}},$$

which restricts to a poset isomorphism onto $\text{cl}(T) = (F_{-1}, T]$.

We now give brief explanations of these properties.

ABSTRACT POLYTOPE As explained in [Definition 2.17](#), an abstract polytope is a poset satisfying some of the characteristic combinatorial properties of a convex polytope.

RECURSIVE This property reflects the fact that if S is a stratum in $\bar{\mathcal{M}}_n$ corresponding to a configuration with several disk-components, then the degenerations that can take place in \bar{S} correspond to a choice of a degeneration (or lack thereof) in each of the disk-components. We depict one of the maps γ_T in [Figure 3](#) (using $\bar{\mathcal{M}}_n$ rather than K_r^{tree} or K_r^{br} for clarity). Here the upper-left edge in K_4 is decomposed as the product of K_2 and K_3 , corresponding to the two disk-components appearing in the label on the upper-left edge. These maps give (K_r) the structure of an operad, which is of fundamental importance for applications to symplectic geometry.

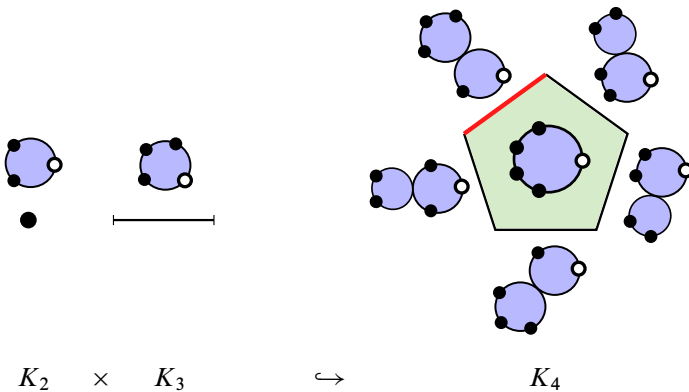

Figure 3: The product $K_2 \times K_3$ identified with a face of K_4

- **Section 3** We construct W_n^{tree} and W_n^{br} and show that they are isomorphic.
 - **Sections 3.1–3.2** Here we define the posets W_n^{tree} and W_n^{br} (see Definitions 3.8 and 3.12), which were motivated in Section 1.1. We also show in Lemma 3.9 that W_n^{tree} specializes to the associahedra and the multiplihedra, which will be important for future applications to symplectic geometry.
 - **Section 3.3** This subsection is devoted to the proof of the following theorem:

Theorem 3.17 (equivalence of the two models for W_n) *The posets W_n^{tree} and W_n^{br} are isomorphic for any $r \geq 1$ and $n \in \mathbb{Z}_{\geq 0}^r \setminus \{\mathbf{0}\}$.*

With this theorem in hand, we define $W_n := W_n^{\text{tree}} = W_n^{\text{br}}$. We also define a forgetful map $\pi: W_n \rightarrow K_r$, which has a simple definition in either model for W_n : the map $\pi^{\text{tree}}: W_n^{\text{tree}} \rightarrow K_r^{\text{tree}}$ sends a tree-pair $T_b \rightarrow T_s$ to the seam tree T_s , and the map $\pi^{\text{br}}: W_n^{\text{br}} \rightarrow K_r^{\text{br}}$ sends a 2–bracketing to the underlying 1–bracketing of $1\ 2 \cdots r$. We depict $\pi^{\text{br}}: W_{200}^{\text{br}} \rightarrow K_3^{\text{br}}$ in Figure 4.

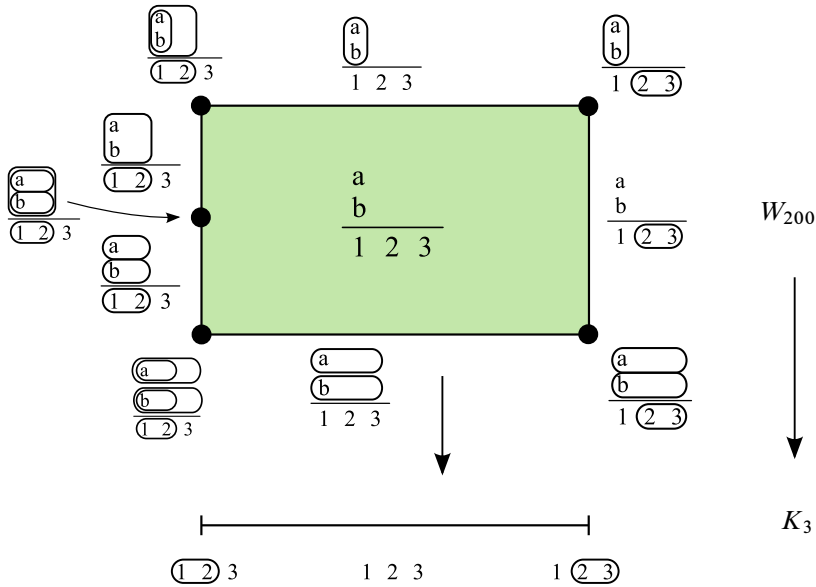

Figure 4

The forgetful map provides an important connection between the 2–associahedra and the associahedra. Together with the RECURSIVE property described below, the forgetful map endows (W_n) with the structure of a *relative 2–operad*, a notion which the author plans to describe in a forthcoming paper.

- **Section 4** This section is devoted to the proof of several properties of W_n , which we collect in this paper’s main theorem.

Theorem 4.1 (key properties of W_n) For any $r \geq 1$ and $n \in \mathbb{Z}_{\geq 0}^r \setminus \{\mathbf{0}\}$, the 2–associahedron W_n is a poset, the collection of which satisfies the following properties:

- **ABSTRACT POLYTOPE** For $n \neq (1)$, the poset $\widehat{W}_n := W_n \cup \{F_{-1}\}$ is an abstract polytope of dimension $|n| + r - 3$.
- **FORGETFUL** W_n is equipped with forgetful maps $\pi: W_n \rightarrow K_r$, which are surjective maps of posets.
- **RECURSIVE** For any stable tree-pair $2T = T_b \xrightarrow{f} T_s \in W_n^{\text{tree}}$, there is an inclusion of posets

$$(3) \quad \Gamma_{2T}: \prod_{\substack{\alpha \in V_{\text{comp}}^1(T_b) \\ \text{in}(\alpha) = (\beta)}} W_{\#\text{in}(\beta)}^{\text{tree}} \times \prod_{\rho \in V_{\text{int}}(T_s)} \prod_{\substack{\alpha \in V_{\text{comp}}^{\geq 2}(T_b) \cap f^{-1}\{\rho\} \\ \text{in}(\alpha) = (\beta_1, \dots, \beta_{\#\text{in}(\rho)})}}^{K_{\#\text{in}(\rho)}} W_{\#\text{in}(\beta_1), \dots, \#\text{in}(\beta_{\#\text{in}(\rho)})}^{\text{tree}} \hookrightarrow W_n^{\text{tree}},$$

where the superscript on one of the product symbols indicates that it is a fiber product with respect to the maps described in FORGETFUL. This inclusion is a poset isomorphism onto $\text{cl}(2T) = (F_{-1}, 2T]$.

We now make remarks about two of these properties.

ABSTRACT POLYTOPE It seems likely that $\overline{2\mathcal{M}_n}$ can be realized as a convex polytope in a way that identifies its face lattice with W_n , but this is not important for the author’s purposes.

RECURSIVE This property is similar to the RECURSIVE property of K_r , but differs in that the closed strata of W_n are fiber products of lower-dimensional 2–associahedra. We depict one of the maps Γ_{2T} in Figure 5 (using $\overline{2\mathcal{M}_n}$ rather than W_n^{tree} or W_n^{br} for clarity). Here the fiber product $W_2 \times W_{100} \times_{K_3} W_{200}$ is included in W_{300} as the green pentagon. (W_{300} is a polyhedron; here we depict its net.) K_3 is the 1–dimensional associahedron, which is an interval, and the maps from W_{100} and W_{200} to K_3 measure the width of the yellow strip.

- **Appendix** We record all 2– and 3–dimensional 2–associahedra (except those which are isomorphic to associahedra). One can immediately see from these examples that the 2–associahedra are not trivial extensions of the associahedra (for instance, products of associahedra). Moreover, these examples are evidence that all 2–associahedra can be realized as convex polytopes.

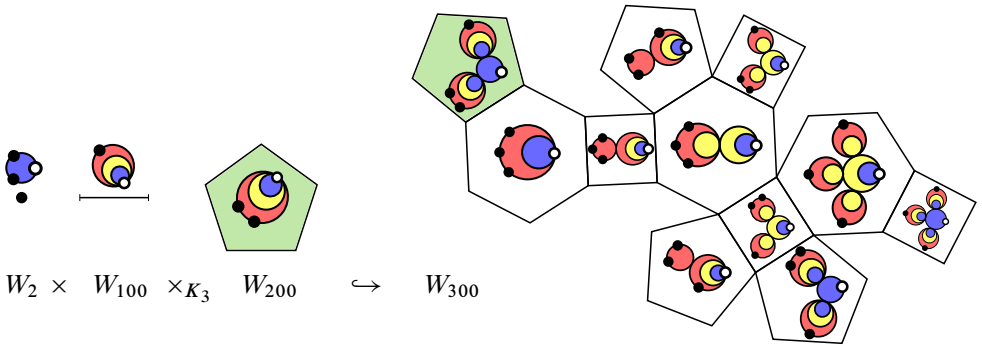

Figure 5

1.3 Future directions

The construction of the 2–associahedra suggests several potential future directions:

- In [3], the author shows that the 2–associahedra have modular realizations in terms of witch curves; these realizations are stratified topological spaces. This fits into a larger project of constructing invariants of collections of Lagrangian correspondences, defined by counting pseudoholomorphic quilts whose domains are witch curves. More progress toward this goal can be found in [4], where a version of Gromov compactness for these quilts is proven using the analysis in [1].
- The associahedra have by now several realizations as convex polytopes, including a realization as the secondary polytopes of certain planar polygons. It is natural to wonder whether the 2–associahedra can also be realized as convex polytopes, in particular as secondary or fiber polytopes (a possibility suggested by Gabriel Kerr). Realizability as convex polytopes is not clearly relevant for applications to symplectic geometry, but a realization as secondary or fiber polytopes could suggest additional structure relevant to the study of Fukaya categories.
- It is natural to ask whether there is a notion of “ m –associahedra” for all $m \geq 1$. The author believes that this concept should be relatively straightforward to define, but he does not have a need for this generalization and therefore has no plans to investigate this.
- The author has conjectured that a cellular model for the little 2–disks operad can be built by gluing together copies of $W_{1 \dots 1}$. If this is true, it suggests a way of defining a homotopy Gerstenhaber structure on symplectic cohomology involving only finitely many operations of any given arity.

- Analogously to how an A_∞ -category is the same thing as a category over the operad of associahedra, the author plans to define a notion of A_∞ -2-category as a 2-category over the relative 2-operad of 2-associahedra.

1.4 Notation and conventions

Glossary of notation

Notation	Interpretation	Page defined
$[\alpha, \beta]$	path from α to β in a tree	754
$\alpha(\beta, \gamma, \delta)$	single vertex in $[\beta, \gamma] \cap [\gamma, \delta] \cap [\delta, \beta]$	777
$\alpha(B)$	vertex corresponding to 1-bracket B	760
$\alpha(\mathbf{2B})$	vertex corresponding to 2-bracket $\mathbf{2B}$	776
B	1-bracket	759
$B(\alpha)$	1-bracket corresponding to vertex α	759
\mathcal{B}	1-bracketing	759
$\mathbf{2B} = (B, (2B_i))$	2-bracket	772
$\mathbf{2B}(\alpha)$	2-bracket corresponding to vertex α	776
$(\mathcal{B}, 2\mathcal{B})$	2-bracketing	772
K_r	associahedron, $K_r = K_r^{\text{br}} = K_r^{\text{tree}}$	762
K_r^{br}	poset of 1-bracketings of r	759
K_r^{tree}	poset of rooted ribbon trees with r leaves	757
ν	isomorphism $K_r^{\text{tree}} \rightarrow K_r^{\text{br}}$	759
2ν	isomorphism $W_n^{\text{tree}} \rightarrow W_n^{\text{br}}$	777
π	forgetful map $W_n \rightarrow K_r$	776
$T_{\alpha\beta}$	those vertices γ with $[\alpha, \gamma] \ni \beta$	754
$2T = T_b \xrightarrow{f} T_s$	stable tree-pair with bubble tree T_b and seam tree T_s	766
W_n	2-associahedron, $W_n = W_n^{\text{br}} = W_n^{\text{tree}}$	776
W_n^{br}	poset of 2-bracketings of n	773
W_n^{tree}	poset of stable tree-pairs of type n	767

Conventions Unless otherwise specified, r will denote a positive integer, and \mathbf{n} will denote an element of $\mathbb{Z}_{\geq 0}^r \setminus \{\mathbf{0}\}$. By $|\mathbf{n}|$ we will denote the sum $\sum_{i=1}^r n_i$. For X_1, \dots, X_ℓ posets, each equipped with a map $f_i: X_i \rightarrow Y$ to another poset, we define and denote the *fiber product* of X_1, \dots, X_ℓ over Y like so:

$$(4) \quad \prod_{1 \leq i \leq \ell} X_i := \left\{ (x_1, \dots, x_\ell, y) \in \prod_{1 \leq i \leq \ell} X_i \times Y \mid f_i(x_i) = y \text{ for all } i \right\}.$$

For any poset X and $F, G \in X$, we denote the closed interval $\{H \in X \mid F \leq H \leq G\}$ by $[F, G]$. We will similarly denote half-open and open intervals. If X is a poset with a maximum (resp. minimum) element, we will denote these elements by F_{top}^X (resp. F_{-1}^X) and omit the superscripts when the poset is obvious.

Note that when $\ell = 0$, the “empty fiber product over Y ” is Y itself, and that when $\ell = 1$ and $f_1: X_1 \rightarrow Y$ is surjective, this fiber product can be identified with X_1 .

Acknowledgements

The ideas presented in this paper evolved over the course of several years, and the author is grateful to a number of people for their insight and support. This project began in 2014, while the author was a graduate student at MIT under the supervision of Katrin Wehrheim; the author is grateful for Professor Wehrheim’s support throughout this project. Conversations with Satyan Devadoss greatly helped in the development of the definition of W_n . Stefan Forcey pointed out the notion of abstract polytope. David Feldman, Nick Sheridan, and the anonymous referees made suggestions that improved the exposition. The author thanks Mohammed Abouzaid, Helmut Hofer, Jacob Lurie, Paul Seidel and James Stasheff for encouragement.

The ideas in this paper were developed while the author was a graduate student at MIT, then a postdoctoral researcher at Northeastern University, and finally a member at the Institute for Advanced Study and a postdoctoral researcher at Princeton University. The author was supported by an NSF Graduate Research Fellowship and an NSF Mathematical Sciences Postdoctoral Research Fellowship.

2 The definition of K_r and some basic properties

In this section we define the associahedra K_r and prove the analogues of Theorems 3.17 and 4.1. We will use K_r later in this paper; besides, the ideas in this section will shed light on the techniques we will use to prove Theorems 3.17 and 4.1.

2.1 Two constructions of K_r : in terms of rooted ribbon trees and in terms of 1-bracketings

In this subsection we will define two posets K_r^{tree} and K_r^{br} , then show that they are isomorphic. We begin by recalling the definition of a tree.

Definition 2.1 A *tree* is a finite set T and a relation $E \subset T \times T$ satisfying these axioms:

- **SYMMETRY** If $\alpha E \beta$, then $\beta E \alpha$.
- **ANTIREFLEXIVITY** If $\alpha E \beta$, then $\alpha \neq \beta$.
- **CONNECTEDNESS** If α, β are distinct vertices, then there are $\gamma_1, \dots, \gamma_k \in T$ with $\gamma_1 = \alpha$, $\gamma_k = \beta$ and $\gamma_i E \gamma_{i+1}$ for every i .
- **NO CYCLES** If $\gamma_1, \dots, \gamma_k$ are vertices with $\gamma_i E \gamma_{i+1}$ and $\gamma_i \neq \gamma_{i+2}$ for all i , then $\gamma_1 \neq \gamma_k$. △

We can now define the model K_r^{tree} .

Definition 2.2 A *rooted ribbon tree* (RRT) is a tree T with a choice of a root $\alpha_{\text{root}} \in T$ and a cyclic ordering of the edges incident to each vertex; we orient such a tree toward the root. We say that a vertex α of an RRT T is *interior* if the set $\text{in}(\alpha)$ of its incoming neighbors is nonempty, and we denote the set of interior vertices of T by T_{int} . An RRT T is *stable* if every interior vertex has at least 2 incoming edges. We define K_r^{tree} to be the set of all isomorphism classes of stable rooted ribbon trees with r leaves.

We denote the i^{th} leaf of an RRT T by λ_i^T . For any $\alpha, \beta \in T$, let $T_{\alpha\beta}$ denote those vertices γ such that the path $[\alpha, \gamma]$ from α to γ passes through β . We write $T_\alpha := T_{\alpha_{\text{root}}\alpha}$. △

See [Figure 6](#) for an illustration of the notation we have just introduced, in the case of a single RRT T .

The following lemma provides a useful alternative characterization of RRTs.

Lemma 2.3 *An RRT is equivalent to the following data:*

- A finite set V of vertices with a distinguished element α_{root} .
- For every $\alpha \in V$, a sequence $\text{in}(\alpha) \subset V$ such that
 - (i) $\text{in}(\alpha) \not\ni \alpha_{\text{root}}$;
 - (ii) for every $\alpha \neq \alpha_{\text{root}}$, there exists a unique vertex β with $\text{in}(\beta) \ni \alpha$; and
 - (iii) if $\alpha_1, \dots, \alpha_\ell$ is a sequence in V with $\ell \geq 2$ and $\alpha_j \in \text{in}(\alpha_{j+1})$ for every j , then $\alpha_1 \neq \alpha_\ell$.

Moreover, the RRT is stable if and only if $\#\text{in}(\alpha) \neq 1$ for every $\alpha \in V$.

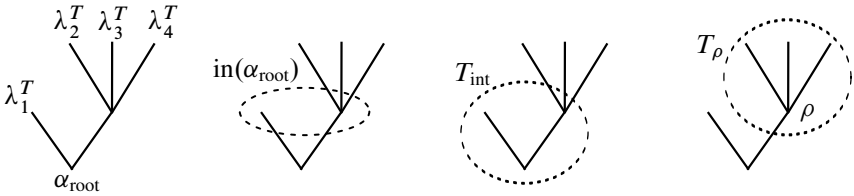

Figure 6: Notation associated to a single RRT T

Proof Throughout this proof, we will abbreviate $\alpha \in \text{in}(\beta)$ by $\alpha < \beta$.

Step 1 Given an RRT, we show that its vertices together with their incoming neighbors satisfy (i)–(iii).

Fix an RRT T . Its root α_{root} is not an incoming neighbor of any vertex, so (i) holds. It is also clear that any $\alpha \neq \alpha_{\text{root}}$ is an incoming neighbor of exactly one vertex, for otherwise the NO CYCLES property would not hold; therefore (ii) holds. Finally, if $\alpha_1 < \dots < \alpha_\ell$ is a sequence of vertices with $\ell \geq 2$, then $\text{dist}(\alpha_j, \alpha_{\text{root}}) = \text{dist}(\alpha_{j+1}, \alpha_{\text{root}}) + 1$ for every j , so $\alpha_1 \neq \alpha_\ell$.

Step 2 Given a finite set $V \ni \alpha_{\text{root}}$ and sequences $\text{in}(\alpha)$ for $\alpha \in V$ that satisfy (i)–(iii), we produce an RRT having V as its vertices and $\text{in}(\alpha)$ as the incoming neighbors of α , ordered according to the order of $\text{in}(\alpha)$.

Given this data, define a tree T by

$$(5) \quad V(T) := V, \quad \alpha E \beta \iff \alpha < \beta \text{ or } \beta < \alpha.$$

This relation is clearly symmetric, and its antireflexivity follows from the $\ell = 2$ case of (iii).

To prove CONNECTEDNESS, we will show that every vertex is connected to α_{root} . Fix $\alpha \in V \setminus \{\alpha_{\text{root}}\}$, and define a path like so: set $\alpha_1 := \alpha$, and for $j \geq 1$ with $\alpha_j \neq \alpha_{\text{root}}$, set α_{j+1} to be the unique vertex with $\alpha_j < \alpha_{j+1}$. By (iii), this path is nonoverlapping, so since V is finite, this path will eventually terminate at α_{root} .

To prove NO CYCLES, consider a path $\alpha_1, \dots, \alpha_\ell$ with $\ell \geq 3$ and $\alpha_j \neq \alpha_{j+2}$ for every j ; we must show $\alpha_1 \neq \alpha_\ell$. If there exists j with $\alpha_j > \alpha_{j+1} < \alpha_{j+2}$, then $\alpha_j = \alpha_{j+2}$ by (ii), contradicting our assumption. Therefore we must either have (a) $\alpha_1 < \dots < \alpha_\ell$, (b) $\alpha_1 > \dots > \alpha_\ell$, or (c) $\alpha_1 < \dots < \alpha_j < \alpha_{j+1} > \alpha_{j+2} > \dots > \alpha_\ell$. In cases (a) and (b), condition (iii) implies $\alpha_1 \neq \alpha_\ell$. In case (c), suppose $\alpha_1 = \alpha_\ell$. Then (ii) implies that the paths (β_j) (resp. (γ_j)) defined by $\beta_1 := \alpha_1$ and $\beta_{j+1} > \beta_j$ (resp. $\gamma_1 := \alpha_\ell$ and $\gamma_{j+1} > \gamma_j$) coincide, hence $\alpha_j = \alpha_{j+2}$, a contradiction. In all cases we have shown $\alpha_1 \neq \alpha_\ell$, hence NO CYCLES holds.

Finally, we upgrade $V(T)$ to an RRT. Define its root to be $\alpha_{\text{root}} \in V$. With this choice of root, the incoming neighbors of α are exactly the elements of $\text{in}(\alpha)$; order these vertices according to the order on $\text{in}(\alpha)$.

Clearly Steps 1 and 2 are inverse to one another. The stability criterion is also obvious. \square

Now we will define a “dimension” function d on K_r^{tree} . As described in Section 1, K_r^{tree} indexes the strata of a topological space $\overline{\mathcal{M}}_r$; the function d assigns to an element of K_r^{tree} the dimension of the corresponding stratum of $\overline{\mathcal{M}}_r$.

Definition 2.4 For T a stable RRT in K_r^{tree} , define its *dimension* $d(T) \in \mathbb{Z}_{\geq 0}$ by

$$(6) \quad d(T) := r - \#T_{\text{int}} - 1. \quad \triangle$$

Remark 2.5 K_1^{tree} has a single element, the RRT \bullet with a single vertex and no edges; its dimension is zero. \triangle

Lemma 2.6 Fix an RRT $T \in K_r^{\text{tree}}$.

(a) The dimension can be re-expressed using the formula

$$(7) \quad d(T) = \sum_{\alpha \in T_{\text{int}}} (\#\text{in}(\alpha) - 2).$$

(b) If $r \geq 2$, the dimension satisfies the inequality $0 \leq d(T) \leq r - 2$.

Proof (a) Equation (7) is the result of substituting into (6) the identity

$$(8) \quad \sum_{\alpha \in T_{\text{int}}} \#\text{in}(\alpha) = \#T_{\text{int}} + r - 1.$$

This follows by noting that $\sum_{\alpha \in T_{\text{int}}} \#\text{in}(\alpha)$ counts the vertices in T that are an incoming neighbor of another vertex in T . This set is the complement of the root of T , hence has cardinality $\#T_{\text{int}} + r - 1$.

(b) The inequality $d(T) \geq 0$ follows from (7) and the stability hypothesis on T ; the inequality $d(T) \leq r - 2$ follows immediately from (6). \square

We now define moves that can be performed on stable RRTs. As we will show, each move decreases the dimension d by one — and in fact, the moves that can be performed on T correspond to the codimension-1 degenerations that can occur in $\overline{\mathcal{M}}_r$ starting from the stratum corresponding to T . Given a stable RRT T , here is the general description

of a legal move that can be performed on T : choose $\alpha \in T_{\text{int}}$ and a consecutive subset $(\gamma_{p+1}, \dots, \gamma_{p+l}) \subset (\gamma_1, \dots, \gamma_k) = \text{in}(\alpha)$ where l satisfies $2 \leq l < k$ (necessary to preserve stability). The corresponding move consists of modifying the incoming edges of α like so:

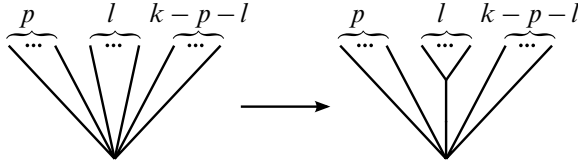

Example 2.7 In Figure 7, we illustrate the notion of a move on an RRT. On the left (resp. right) we show all the RRTs with three (resp. four) leaves, and indicate all moves amongst these RRTs by arrows, each one corresponding to a single move. As we will shortly see, these moves equip the set of RRTs with a fixed number of leaves with the structure of a poset, which in fact is an abstract polytope; for this reason we suggestively overlay the RRTs over polytopes. \triangle

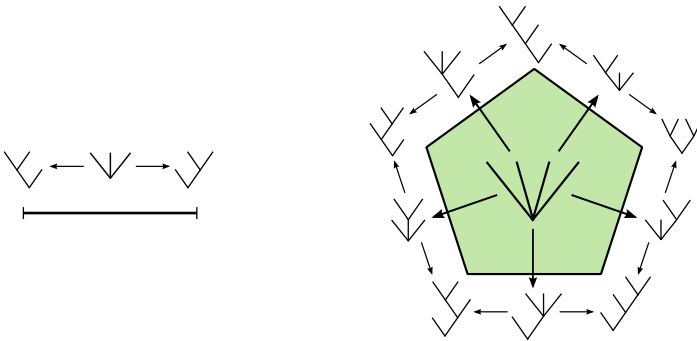

Figure 7

Lemma 2.8 If T is a stable RRT and T' is the result of performing a move on T , then $d(T') = d(T) - 1$.

Proof If T has r leaves, then we have $d(T) = r - \#T_{\text{int}} - 1$. When we perform a move on T , the number of leaves remains the same and one new interior node is created, so d decreases by one. \square

Definition–Lemma 2.9 Define K_r^{tree} as a poset by declaring $T' < T$ if there is a finite sequence of moves that transforms T into T' .

Proof We must check that this defines a partial order on K_r . The reflexivity property follows from Lemma 2.8. Transitivity is immediate. \square

Recall that a *tree homomorphism* is a map $f: T \rightarrow \tilde{T}$ such that $f^{-1}\{\tilde{\alpha}\}$ is a tree for every $\tilde{\alpha} \in \tilde{T}$, and $\alpha E \beta$ implies that either $f(\alpha) = f(\beta)$ or $f(\alpha) \tilde{E} f(\beta)$. An *RRT homomorphism* is a tree homomorphism $f: T \rightarrow \tilde{T}$ that sends leaves to leaves, root to root, interior vertices to interior vertices, and respects the cyclic orderings of edges and the orientation in the following ways:

- Suppose that $\tilde{\beta}_1, \tilde{\beta}_2$ lie in $\text{in}(\tilde{\alpha})$ and satisfy $\tilde{\beta}_1 < \tilde{\beta}_2$. Suppose that β_1, β_2 satisfy $f(\beta_1) = \tilde{\beta}_1, f(\beta_2) = \tilde{\beta}_2$. Choose $\gamma \in T$ to be the first intersection of the path from β_1 to α_{root}^T and the path from β_2 to α_{root}^T , and define δ_1 and δ_2 to be the respective incoming neighbors of γ that these two paths pass through. Then $\delta_1 < \delta_2$.
- Suppose α lies in T and β lies in $\text{in}(\alpha)$. Then either $f(\beta) = f(\alpha)$ or $f(\beta) \in \text{in}(\alpha)$.

If \tilde{T} is the result of performing a sequence of moves on a stable RRT T , then there is a surjective RRT homomorphism $\tilde{T} \rightarrow T$ gotten by contracting the edges added to T to form \tilde{T} . As the next lemma shows, all surjective homomorphisms of stable RRTs can be obtained in this fashion.

Lemma 2.10 *If $f: \tilde{T} \rightarrow T$ is a surjective homomorphism of stable RRTs, then \tilde{T} can be obtained from T by applying a finite sequence of moves, and f is the map that contracts the new edges that were added to T to form \tilde{T} .*

Proof We begin by showing that T and \tilde{T} have the same number of leaves, and that f satisfies $f(\lambda_i^T) = \lambda_i^{\tilde{T}}$ for all i . For this, it suffices to show that f is injective on leaves. Suppose that $f(\lambda_i^T) = f(\lambda_j^T)$ for some $i \neq j$. The preimage of every vertex in \tilde{T} is connected, so the outgoing neighbor of λ_i^T must also be sent to $f(\lambda_i^T)$. This contradicts the hypothesis that f sends interior vertices to interior vertices.

We prove the lemma by induction on $\#\tilde{T} - \#T$. If \tilde{T} and T have the same number of vertices, then they are isomorphic and the claim is trivially true. Next, suppose we have proven the claim as long as the inequality $\#\tilde{T} - \#T \leq k$ holds, and suppose that \tilde{T}, T satisfy $\#\tilde{T} = \#T + k + 1$. Choose an edge $\tilde{\alpha} \tilde{E} \tilde{\beta}$ with $f(\tilde{\alpha}) = f(\tilde{\beta})$, and assume that $\tilde{\beta}$ is further from the root than $\tilde{\alpha}$. Define T' to be the stable RRT gotten by contracting $\tilde{\alpha} \tilde{E} \tilde{\beta}$ in \tilde{T} . Then \tilde{T} can be obtained from T' by making a single move. Moreover, $f: \tilde{T} \rightarrow T$ can be factored as $\tilde{T} \rightarrow T' \rightarrow T$, where $\tilde{T} \rightarrow T'$ is the map that contracts $\tilde{\alpha} \tilde{E} \tilde{\beta}$, and $g: T' \rightarrow T$ is defined by

$$(9) \quad g(\tilde{\gamma}) := \begin{cases} f(\tilde{\alpha}) & \text{if } \tilde{\gamma} \in \{\tilde{\alpha}, \tilde{\beta}\}, \\ f(\tilde{\gamma}) & \text{otherwise.} \end{cases}$$

By induction, $g: T' \rightarrow T$ is the result of applying finitely many moves to T , so we have proven the claim by induction. \square

Another way to characterize a stable RRT is as a 1-bracketing of $\{1, \dots, r\}$. Each 1-bracket corresponds to the RRT's local structure at a particular interior vertex.

Definition 2.11 A 1-bracket of r is a nonempty consecutive subset $B \subset \{1, \dots, r\}$. A 1-bracketing of r is a collection \mathcal{B} of 1-brackets of r satisfying these properties:

- **BRACKETING** If $B, B' \in \mathcal{B}$ have $B \cap B' \neq \emptyset$, then either $B \subset B'$ or $B' \subset B$.
- **ROOT AND LEAVES** \mathcal{B} contains $\{1, \dots, r\}$ and $\{i\}$ for every i .

We denote the set of all 1-bracketings of r by K_r^{br} , and define a partial order by defining $\mathcal{B}' < \mathcal{B}$ if \mathcal{B}' is a proper subcollection of \mathcal{B} . \triangle

Definition 2.12 Fix a stable tree $T \in K_r^{\text{tree}}$. A T -bracket is a 1-bracket B of r with the property that there is some $\alpha \in T$ such that B is the set of indices i for which T_α contains λ_i . We denote this bracket by $B(\alpha) := B$. \triangle

Note that since T is stable, the T -brackets are in bijective correspondence with the vertices of T .

Proposition 2.13 The function $\nu: K_r^{\text{tree}} \rightarrow K_r^{\text{br}}$ that sends a stable RRT T to the set of T -brackets is an isomorphism of posets.

Proof We break the proof down into four steps.

Step 1 If T is a stable RRT with r leaves, then $\nu(T)$ is a 1-bracketing of r .

We have $B(\alpha_{\text{root}}) = \{1, \dots, r\}$ and $B(\lambda_i^T) = \{i\}$, so $\nu(T)$ contains $\{1, \dots, r\}$ and $\{i\}$ for every i . Clearly every $B(\alpha) \in \nu(T)$ is nonempty and consecutive. Finally, if $\alpha, \beta \in T$ have neither $\alpha \in T_\beta$ nor $\beta \in T_\alpha$, then $B(\alpha) \cap B(\beta) = \emptyset$: indeed, if $i \in B(\alpha) \cap B(\beta)$, then the path from λ_i to α_{root} passes through both α and β . On the other hand, if $\beta \in T_\alpha$, then $B(\beta) \subset B(\alpha)$.

Step 2 We define a putative inverse $\tau: K_r^{\text{br}} \rightarrow K_r^{\text{tree}}$.

Given $\mathcal{B} \in K_r^{\text{br}}$, we will define $\tau(\mathcal{B})$ via Lemma 2.3. Define

$$(10) \quad \begin{aligned} V &:= \mathcal{B}, \quad \{1, \dots, r\} =: \alpha_{\text{root}} \in V, \\ B' \in \text{in}(B) &\iff (B' \subsetneq B \text{ and } \nexists B'' \in \mathcal{B} \text{ such that } B' \subsetneq B'' \subsetneq B), \end{aligned}$$

and denote the vertex corresponding to $B \in \mathfrak{B}$ by $\alpha(B)$. Any distinct vertices $\alpha(B'), \alpha(B'') \in \text{in}(\alpha(B))$ must have $B' \cap B'' = \emptyset$, since otherwise one of B' and B'' would be properly contained in the other; we may therefore order $\text{in}(\alpha(B))$ by declaring that $\alpha(B'), \alpha(B'') \in \text{in}(\alpha(B))$ have $\alpha(B') <_{\alpha(B)} \alpha(B'')$ if and only if $i' < i''$ for all $i' \in B'$ and $i'' \in B''$.

We now verify conditions (i)–(iii) from Lemma 2.3. To prove (i), note that for any $\alpha(B) \in V$ and $\alpha(B') \in \text{in}(\alpha(B))$, we have that B' is a proper subset of B ; therefore $\text{in}(\alpha(B))$ does not contain $\alpha(\{1, \dots, r\}) = \alpha_{\text{root}}$. For (ii), fix $\alpha(B) \in V \setminus \{\alpha_{\text{root}}\}$ and define $\Sigma := \{B' \in \mathfrak{B} \mid B' \supsetneq B\}$. Then Σ contains $\{1, \dots, r\}$, hence is nonempty. Moreover, if $B', B'' \in \Sigma$ are distinct and minimal with respect to inclusion, then $B' \cap B'' \supset B \neq \emptyset$; therefore one of B' and B'' must contain the other, a contradiction to minimality. This shows that Σ contains a unique minimal element, which is the unique B' with $\text{in}(\alpha(B')) \ni \alpha(B)$; this establishes (ii). Finally, if $\alpha(B^1), \dots, \alpha(B^\ell)$ is a sequence in V with $\ell \geq 2$ and $\alpha(B^j) \in \text{in}(\alpha(B^{j+1}))$ for every j , then $B^1 \subsetneq B^\ell$, hence $\alpha(B^1) \neq \alpha(B^\ell)$.

It is clear that $\tau(\mathfrak{B})$ is stable and that $\{i\}$ is the i^{th} leaf of $\tau(\mathfrak{B})$.

Step 3 We show that ν and τ are inverse bijections.

First, fix $T \in K_r^{\text{tree}}$; we claim $T \simeq \tau(\nu(T))$. There is an obvious identification of vertices, which identifies root with root. Next, we must show that the edge relations on the vertices T are the same, which is to say that $\beta \in \text{in}(\alpha)$ is equivalent to $B(\beta) \subsetneq B(\alpha)$ and the nonexistence of $\gamma \in T$ with $B(\beta) \subsetneq B(\gamma) \subsetneq B(\alpha)$.

Fix $\beta \in \text{in}(\alpha)$. Certainly $B(\beta) \subset B(\alpha)$, and this containment is proper by the stability of T . (Indeed, define an outgoing path by setting $\delta_1 := \alpha$, choosing δ_2 to be an incoming neighbor of α other than β , and inductively defining δ_{i+1} to be an incoming neighbor of δ_i as long as $\text{in}(\delta_i)$ is not empty. This path will terminate, by condition (iii) in Lemma 2.3. Moreover, this path does not include β : if it did, it would by (ii) have $\delta_i = \alpha$ for some $i \geq 2$, which is impossible by (iii). If λ_j is the leaf at which this path terminates, then $j \in B(\alpha) \setminus B(\beta)$.) Suppose for the sake of contradiction that there exists γ with $B(\beta) \subsetneq B(\gamma) \subsetneq B(\alpha)$, and choose $i \in B(\beta)$. Since $B(\alpha), B(\beta), B(\gamma)$ all contain i , the path $[\lambda_i, \alpha_{\text{root}}]$ must contain α, β, γ . The containments $B(\beta) \subsetneq B(\gamma) \subsetneq B(\alpha)$ now imply that the path $\beta = \delta_1, \delta_2, \dots, \delta_\ell = \alpha$ from β to α is oriented toward the root and has $\delta_i = \gamma$ for some $i \in [2, \ell - 1]$. Without loss of generality we may assume $i = 2$. Then $\beta \in \text{in}(\gamma)$, so β cannot lie in $\text{in}(\alpha)$, a contradiction.

Conversely, suppose that $B(\beta) \subsetneq B(\alpha)$ and that there does not exist γ such that $B(\beta) \subsetneq B(\gamma) \subsetneq B(\alpha)$. An argument similar to the one in the previous paragraph yields $\beta \in \text{in}(\alpha)$.

Second, fix $\mathfrak{B} \in K_r^{\text{br}}$; we claim $\mathfrak{B} = \nu(\tau(\mathfrak{B}))$. To prove this, it suffices to show that $\alpha(\{i\}) \in T_{\alpha(B)}$ if and only if $i \in B$. Suppose $\alpha(\{i\}) \in T_{\alpha(B)}$. This means that there is a sequence of 1-brackets $\{i\} = B_1, B_2, \dots, B_\ell = B$ in \mathfrak{B} such that for every i , either (a) $B_i \subsetneq B_{i+1}$ and there exists no $B' \in \mathfrak{B}$ with $B_i \subsetneq B' \subsetneq B_{i+1}$, or (b) the same holds but with B_i and B_{i+1} interchanged. In fact, an argument similar to the one made in the proof of NO CYCLES in Lemma 2.3 implies that for every i it is (a) that holds. Therefore i lies in B . Conversely, suppose $i \in B$. Define a sequence in \mathfrak{B} by setting $B_1 := B$ and, as long as B_i is not equal to $\{i\}$, defining B_{i+1} to be the largest element of \mathfrak{B} satisfying $B_i \supsetneq B_{i+1} \supsetneq \{i\}$. This defines a non-self-intersecting path in $\tau(\mathfrak{B})$ that begins at $\alpha(B)$ and terminates at the i^{th} leaf, which proves the backwards direction of the assertion that $\alpha(\{i\}) \in T_{\alpha(B)}$ is equivalent to $i \in B$.

Step 4 We show that ν and τ respect the partial orders on K_r^{tree} and K_r^{br} .

First, we show that if $T' < T$, then $\nu(T') < \nu(T)$. We may assume without loss of generality that T' is the result of performing a single move on T . Denote by $\alpha \in T$ the vertex at which the move is performed, so that T' is produced from T by introducing a new incoming neighbor of α . We may therefore regard $V(T)$ as a subset of $V(T')$. If β is a vertex of T , and $B(\beta)$ (resp. $B'(\beta)$) denote the indices of the leaves in T_β (resp. in T'_β), then $B(\beta) = B'(\beta)$. Therefore $\nu(T') < \nu(T)$.

Second, we show that if $\mathfrak{B}' < \mathfrak{B}$, then $\tau(\mathfrak{B}') < \tau(\mathfrak{B})$. Define $f: \tau(\mathfrak{B}') \rightarrow \tau(\mathfrak{B})$ by

$$(11) \quad f(\alpha(B')) := \alpha(\min\{B \in \mathfrak{B} \mid B \supset B'\}),$$

where the minimum is taken with respect to inclusion. By ROOT AND LEAVES, the set over which we are taking the minimum contains $\{1, \dots, r\}$, hence is nonempty; therefore f is well-defined. I claim that f is a surjective homomorphism of stable RRTs. Again by ROOT AND LEAVES, f sends $\lambda_i^{\tau(\mathfrak{B}')}$ to $\lambda_i^{\tau(\mathfrak{B})}$ and $\alpha_{\text{root}}^{\tau(\mathfrak{B}')}$ to $\alpha_{\text{root}}^{\tau(\mathfrak{B})}$; since \mathfrak{B} is a subcollection of \mathfrak{B}' , it follows that f is surjective. It remains to show that the preimage under f of each vertex in $\tau(\mathfrak{B})$ is connected. Fix $B \in \mathfrak{B}$; it suffices to show that for any $B' \in \mathfrak{B}'$ with $f(\alpha(B')) = \alpha(B)$, the path from $\alpha(B')$ to $\alpha(B)$ in $\tau(\mathfrak{B}')$ is contained in $f^{-1}\{\alpha(B)\}$. This is apparent from the definition of f , so we may conclude that f is a surjective morphism of stable RRTs, hence $\tau(\mathfrak{B}') < \tau(\mathfrak{B})$ by Lemma 2.10. □

By this lemma, we may define $K_r := K_r^{\text{tree}} = K_r^{\text{br}}$.

2.2 \widehat{K}_r is an abstract polytope of dimension $r - 2$

In this subsection we prove the following proposition.

Proposition 2.14 (key properties of K_r) *The posets (K_r) satisfy the following properties:*

- **ABSTRACT POLYTOPE** *For $r \geq 2$, the poset $\widehat{K}_r := K_r \cup \{F_{-1}\}$ is an abstract polytope of dimension $r - 2$.*
- **RECURSIVE** *For any $T \in K_r^{\text{tree}}$, there is an inclusion of posets*

$$(12) \quad \gamma_T: \prod_{\alpha \in T_{\text{int}}} K_{\#\text{in}(\alpha)}^{\text{tree}} \hookrightarrow K_r^{\text{tree}},$$

which restricts to a poset isomorphism onto $\text{cl}(T) = (F_{-1}, T]$.

Proof These two properties are proven in [Proposition 2.18](#) and [Definition–Lemma 2.15](#) respectively. □

We begin by establishing RECURSIVE. After the proof of [Definition–Lemma 2.15](#), we will illustrate the definition of γ_T in an example.

Definition–Lemma 2.15 *Fix $r \geq 2$ and $T \in K_r^{\text{tree}}$. Define a map*

$$(13) \quad \gamma_T: \prod_{\alpha \in T_{\text{int}}} K_{\#\text{in}(\alpha)}^{\text{tree}} \rightarrow K_r^{\text{tree}}$$

by sending $(T^\beta)_{\beta \in \text{in}(\alpha)}$ to the RRT gotten by replacing each β and its incoming neighbors and edges by T^β . Then γ_T restricts to a poset isomorphism from its domain to $\text{cl}(T)$.

Proof We will define an inverse $\sigma_T: \text{cl}(T) \rightarrow \prod_{\alpha \in T_{\text{int}}} K_{\#\text{in}(\alpha)}^{\text{tree}}$ to the restriction of γ_T . Fix $\widehat{T} \in \text{cl}(T)$; then there is a (unique) surjective homomorphism $f: \widehat{T} \rightarrow T$ of ribbon trees. For any $\alpha \in T$, define $\widehat{\alpha} \in \widehat{T}$ to be the element of $f^{-1}\{\alpha\}$ that is closest to the root. For any $\alpha \in T_{\text{int}}$, define

$$(14) \quad \widehat{T}^\alpha := f^{-1}\{\alpha\} \cup \{\widehat{\beta} \mid \beta \in \text{in}(\alpha)\}, \quad \alpha_{\text{root}}^{\widehat{T}^\alpha} := \widehat{\alpha}.$$

Then \widehat{T}^α is a subtree of \widehat{T} : since f is a tree homomorphism, $f^{-1}\{\alpha\}$ is a subtree of \widehat{T} . For any $\beta \in \text{in}(\alpha)$, we must either have $f(\text{out}(\widehat{\beta})) = f(\widehat{\beta}) = \beta$ or $f(\text{out}(\widehat{\beta})) = \text{out}(f(\widehat{\beta})) = \alpha$; by the definition of $\widehat{\beta}$, the latter equality must hold, so \widehat{T}^α is indeed a subtree of \widehat{T} . Furthermore, the ribbon tree structure of \widehat{T} induces a ribbon tree structure on \widehat{T}^α , so \widehat{T}^α is an RRT. I claim that \widehat{T}^α is stable and has leaves in bijection with $\text{in}(\alpha)$. For any $\beta \in \text{in}(\alpha)$, it follows immediately from the definition of $\widehat{\beta}$ that $\widehat{\beta} \in \widehat{T}^\alpha$ is a leaf. Next, fix $\beta \in f^{-1}\{\alpha\}$; we must show $\beta \in \widehat{T}^\alpha$ has at least 2 incoming neighbors. In fact, its incoming neighbors are in correspondence with the incoming neighbors of β in \widehat{T} . We may conclude that \widehat{T}^α is a stable RRT with leaves in correspondence with $\text{in}(\alpha)$. We may now define σ_T by

$$(15) \quad \sigma_T: \text{cl}(T) \rightarrow \prod_{\alpha \in T_{\text{int}}} K_{\#\text{in}(\alpha)}^{\text{tree}}, \quad \sigma_T(\widehat{T}) := (\widehat{T}^\alpha)_{\alpha \in T_{\text{int}}}.$$

It is clear from the definition of σ_T that it is an inverse to the restriction

$$\gamma_T: \prod_{\alpha \in T_{\text{int}}} K_{\#\text{in}(\alpha)}^{\text{tree}} \rightarrow \text{cl}(T).$$

Clearly γ_T and σ_T also respect the partial orders on $\prod_{\alpha \in T_{\text{int}}} K_{\#\text{in}(\alpha)}^{\text{tree}}$ and K_r^{tree} . \square

Example 2.16 We illustrate the definition of γ_T in a simple example:

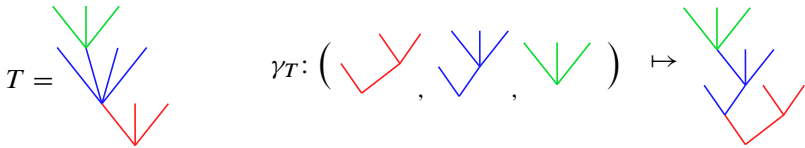

On the left is T , which has three interior vertices, the incoming edges of which are colored red, blue or green, respectively. The map γ_T acts by replacing the red, blue and green corollas by RRTs in K_3^{tree} , K_4^{tree} and K_3^{tree} , respectively. \triangle

We now turn to the proof of the ABSTRACT POLYTOPE property from Proposition 2.14. Define $\widehat{K}_r := K_r \cup \{F_{-1}\}$, where F_{-1} is a formal minimal element with $d(F_{-1}) := -1$. We first recall the notion of abstract polytope.

Definition 2.17 An abstract polytope of rank $n \in \mathbb{Z}_{\geq -1}$ is a partially ordered set P (whose elements are called faces) satisfying the four properties defined below.

- **EXTREMAL** P has a least and a greatest face, denoted by F_{-1} and F_{top} , respectively.
- **FLAG-LENGTH** Every flag (ie maximal chain) of P has length $n + 1$, ie contains $n + 2$ faces.

For $F, G \in P$ with $F \leq G$, recall that the closed interval $[F, G]$ is defined by

$$(16) \quad [F, G] := \{H \in P \mid F \leq H \leq G\}.$$

It follows from EXTREMAL and FLAG-LENGTH that we can endow P with a rank function, where $\text{rk } F$ is defined to be the rank of the poset $[F_{-1}, F]$.

- **STRONGLY CONNECTED** For every $F < G$ with $\text{rk } G - \text{rk } F \geq 3$ and for every $H, H' \in (F, G)$, there is a sequence $(H = H_1, H_2, \dots, H_k = H')$ in (F, G) such that H_i and H_{i+1} are adjacent for every i (ie either $H_i < H_{i+1}$ or $H_{i+1} < H_i$, where we write $F_1 < F_2$ if $F_1 < F_2$ and there exists no F_3 with $F_1 < F_3 < F_2$).
- **DIAMOND** For every $F < G$ with $\text{rk } G - \text{rk } F = 2$, the open interval (F, G) contains exactly 2 elements. △

Proposition 2.18 For $r \geq 2$, the poset \widehat{K}_r is an abstract polytope of dimension $r - 2$.

Proof We verify the four properties.

- **EXTREMAL** The least face is the face F_{-1} we have added to K_r to form \widehat{K}_r . The greatest face (in $\widehat{K}_r^{\text{br}}$) is the 1-bracketing $\{\{1, \dots, r\}, \{1\}, \dots, \{r\}\}$.
- **FLAG-LENGTH** We must show that if $T^0 < \dots < T^\ell$ is a maximal chain in K_r^{tree} , then $\ell = r - 2$. By Lemmas 2.6 and 2.8, we have $0 \leq d(T^0) < \dots < d(T^\ell) \leq r - 2$. To prove the claim, we must show that every dimension between 0 and $r - 2$ is represented. For any T^i, T^{i+1} , we must have $d(T^i) = d(T^{i+1}) - 1$: otherwise, there exists $T' \in K_r^{\text{tree}}$ which can be obtained by performing a single move to T^{i+1} , and which satisfies $d(T^i) < d(T') < d(T^{i+1})$; this contradicts the maximality of the chain. Again by maximality, we must have $T^\ell = F_{\text{top}}$. It remains to show $d(T^0) = 0$. Suppose for the sake of contradiction that $d(T^0)$ is positive; then by Lemma 2.6, there exists $\alpha \in T_{\text{int}}^0$ with $\# \text{in}(\alpha) \geq 3$. It follows that we may perform a move to T^0 , so there exists $T' \in K_r^{\text{tree}}$ with $T' < T^0$, contradicting the maximality of this chain.
- **STRONGLY CONNECTED** In this step we may assume $r \geq 4$, since otherwise STRONGLY CONNECTED is vacuous. First, we show that \widehat{K}_r is connected. It suffices to show that for any $a, b \geq 2$ with $a + b - 1 = r$ and i with $1 \leq i \leq a$, there exists a path in $\widehat{K}_r \setminus F_{\text{top}}$ between these two codimension-1 faces:

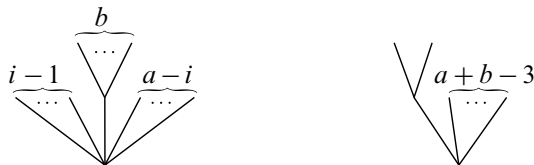

We produce such a path in the following four, exhaustive, cases:

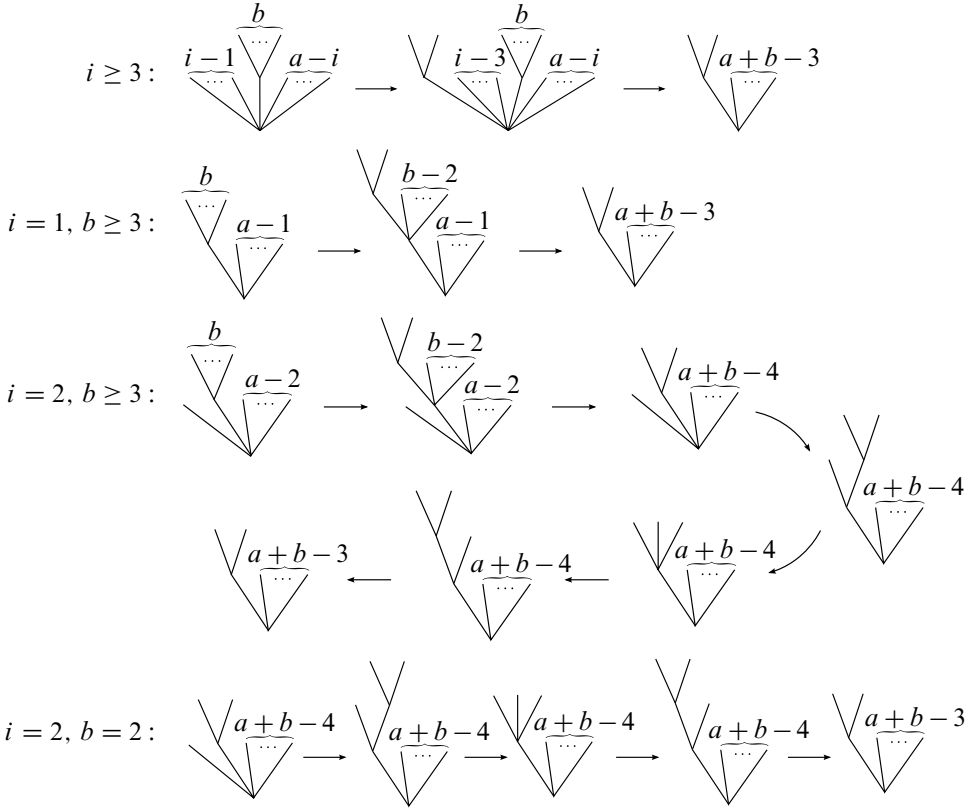

Next, we show that for any $T \in K_r^{\text{tree}}$ with $d(T) \geq 2$, the interval $[F_{-1}, T]$ is connected. By Definition–Lemma 2.15, $[F_{-1}, T]$ is isomorphic to $\{F_{-1}\} \cup \prod_{\alpha \in T_{\text{int}}} K_{\#\text{in}(\alpha)}^{\text{tree}}$. The connectedness of $\widehat{K}_s^{\text{tree}}$ for $s \geq 4$, the fact that K_3^{tree} is isomorphic to the face poset of an interval, and the inequality $\sum_{\alpha \in T_{\text{int}}} (\#\text{in}(\alpha) - 2) = d(T) \geq 2$ imply that $\{F_{-1}\} \cup \prod_{\alpha \in T_{\text{int}}} K_{\#\text{in}(\alpha)}^{\text{tree}}$ is connected.

Finally, we show that for any \mathcal{B} and \mathcal{B}' with $\mathcal{B}' < \mathcal{B}$ and $d(\mathcal{B}') \leq d(\mathcal{B}) - 3$, the interval $[\mathcal{B}', \mathcal{B}]$ is connected. Extend the dimension function d to K_r^{br} via the identification $K_r^{\text{br}} \simeq K_r^{\text{tree}}$. Then $d(\mathcal{B}) = 2r - \#\mathcal{B} - 1$. To prove that $[\mathcal{B}', \mathcal{B}]$ is connected, it suffices to show that for any distinct $\widetilde{\mathcal{B}}^1, \widetilde{\mathcal{B}}^2 \in (\mathcal{B}', \mathcal{B})$ with $d(\widetilde{\mathcal{B}}^1) = d(\widetilde{\mathcal{B}}^2) = d(\mathcal{B}) - 1$, there is a path from $\widetilde{\mathcal{B}}^1$ to $\widetilde{\mathcal{B}}^2$ in $(\mathcal{B}', \mathcal{B})$. The inequality $\widetilde{\mathcal{B}}^j \geq \mathcal{B}'$ for $j \in \{1, 2\}$ implies that $\widehat{\mathcal{B}} := \widetilde{\mathcal{B}}^1 \cup \widetilde{\mathcal{B}}^2$ is a 1-bracketing. Moreover, it satisfies $\widehat{\mathcal{B}} \in [\mathcal{B}', \mathcal{B}]$, and by the formula for the dimension of a 1-bracketing given above, it satisfies $d(\widehat{\mathcal{B}}) = d(\mathcal{B}) - 2$. Since $d(\mathcal{B}') \leq d(\mathcal{B}) - 3$ by hypothesis, $\widehat{\mathcal{B}}$ must therefore lie in $(\mathcal{B}', \mathcal{B})$, so $(\widetilde{\mathcal{B}}^1, \widehat{\mathcal{B}}, \widetilde{\mathcal{B}}^2)$ is a path in $(\mathcal{B}', \mathcal{B})$.

- **DIAMOND** First, fix $T \in K_r^{\text{tree}}$ with $d(T) = 1$; we must show that the open interval (F_{-1}, T) contains exactly two elements. Lemma 2.6 implies that every vertex in T_{int} has two incoming neighbors except for a single α with $\# \text{in}(\alpha) = 3$. Denote the incoming neighbors of α by $(\beta_1, \beta_2, \beta_3)$. There are two possible moves that can be made at α , by either splitting off (α_1, α_2) or (α_2, α_3) . In fact, these are the only two moves that can be performed on T . Since $d(T) = 1$, (F_{-1}, T) contains two elements.

Next, fix $\mathcal{B}, \mathcal{B}' \in K_r^{\text{br}}$ with $d(\mathcal{B}') = d(\mathcal{B}) - 2$. It follows from the definition of d and Proposition 2.13 that \mathcal{B}' is obtained from \mathcal{B} by adding two 1-brackets. From this it is clear that the open interval $(\mathcal{B}', \mathcal{B})$ contains two elements. □

3 Construction of the 2–associahedra W_n

In this section, we define the posets W_n^{tree} (Section 3.1) and W_n^{br} (Section 3.2), then show that they are isomorphic (Section 3.3). This allows us to define the 2–associahedron by $W_n := W_n^{\text{tree}} = W_n^{\text{br}}$.

3.1 The poset W_n^{tree} of stable tree-pairs

We begin with the definition of W_n^{tree} . It is rather technical, and we advise the reader to refer to Example 3.2 while looking at this definition for the first time.

Definition 3.1 A *stable tree-pair of type n* is a datum $2T = T_b \xrightarrow{f} T_s$, with T_b, T_s , and f as described below:

- The *bubble tree* T_b is an RRT whose edges are either solid or dashed, which must satisfy these properties:
 - The vertices of T_b are partitioned as $V(T_b) = V_{\text{comp}} \sqcup V_{\text{seam}} \sqcup V_{\text{mark}}$, where
 - * every $\alpha \in V_{\text{comp}}$ has ≥ 1 solid incoming edge, no dashed incoming edges, and either a dashed or no outgoing edge;
 - * every $\alpha \in V_{\text{seam}}$ has ≥ 0 dashed incoming edges, no solid incoming edges, and a solid outgoing edge; and
 - * every $\alpha \in V_{\text{mark}}$ has no incoming edges and either a dashed or no outgoing edge.

We partition $V_{\text{comp}} =: V_{\text{comp}}^1 \sqcup V_{\text{comp}}^{\geq 2}$ according to the number of incoming edges of a given vertex.

- **STABILITY** If α is a vertex in V_{comp}^1 and β is its incoming neighbor, we must have $\#\text{in}(\beta) \geq 2$; if α is a vertex in $V_{\text{comp}}^{\geq 2}$ and $\beta_1, \dots, \beta_\ell$ are its incoming neighbors, then there exists j with $\#\text{in}(\beta_j) \geq 1$.
- The *seam tree* T_s is an element of K_r^{tree} .
- The *coherence map* is a map $f: T_b \rightarrow T_s$ of sets having these properties:
 - f sends root to root, and if $\beta \in \text{in}(\alpha)$ in T_b , then either $f(\beta) \in \text{in}(f(\alpha))$ or $f(\alpha) = f(\beta)$.
 - f contracts all dashed edges, and every solid edge whose terminal vertex is in V_{comp}^1 .
 - For any $\alpha \in V_{\text{comp}}^{\geq 2}$, the incoming edges of α map bijectively onto the incoming edges of $f(\alpha)$, compatibly with $<_\alpha$ and $<_{f(\alpha)}$.
 - f sends every element of V_{mark} to a leaf of T_s , and if $\lambda_i^{T_s}$ is the i^{th} leaf of T_s , then $f^{-1}\{\lambda_i^{T_s}\}$ contains n_i elements of V_{mark} , which we denote by $\mu_{i1}^{T_b}, \dots, \mu_{in_i}^{T_b}$.

We denote by W_n^{tree} the set of isomorphism classes of stable tree-pairs of type \mathbf{n} . Here an isomorphism from $T_b \xrightarrow{f} T_s$ to $T'_b \xrightarrow{f'} T'_s$ is a pair of maps $\varphi_b: T_b \rightarrow T'_b$ and $\varphi_s: T_s \rightarrow T'_s$ that fit into a commutative square in the obvious way and that respect all the structure of the bubble trees and seam trees. △

Example 3.2 Figure 8 illustrates some of the notation just introduced. We picture the same tree-pair (with $r = 5$, $\mathbf{n} = (1, 1, 4, 1, 0)$) three times, each time indicating different data. In each case, T_b is above and T_s is below. On the left, we label the roots of T_b and T_s , the leaves of T_s , and the elements of $V_{\text{mark}}(T_b)$. In the middle, we indicate the coherence map $f: T_b \rightarrow T_s$: we color the edges of T_s , and use those same colors to show which edges in T_b are identified with the various edges of T_s . Some edges in T_b are contracted by f , which we indicate by using black. On the right, we show how the vertices of T_b are partitioned into V_{mark} , V_{seam} and V_{comp} . △

Definition 3.3 For $2T$ a stable tree-pair, we define the *dimension* $d(2T) \in \mathbb{Z}$ by

$$(17) \quad d(2T) := |\mathbf{n}| + r - \#V_{\text{comp}}^1(T_b) - \#(T_s)_{\text{int}} - 2. \quad \triangle$$

Remark 3.4 The set W_1^{tree} has a single element, the stable tree-pair $\bullet \rightarrow \bullet$; its dimension is zero. △

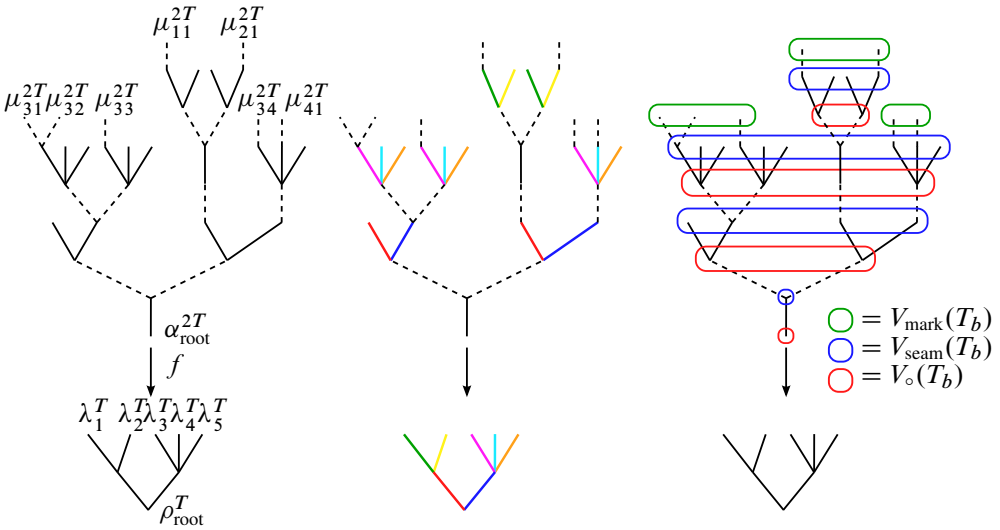

Figure 8

Lemma 3.5 Fix a stable tree-pair $2T \in W_n$.

(a) The dimension can be re-expressed as

$$(18) \quad d(2T) = \sum_{\substack{\alpha \in V_{\text{comp}}^1(T_b) \\ \text{in}(\alpha) = (\beta)}} (\# \text{in}(\beta) - 2) + \sum_{\alpha \in V_{\text{comp}}^{\geq 2}(T_b)} \left(\left(\sum_{\beta \in \text{in}(\alpha)} \# \text{in}(\beta) \right) - 1 \right) + \sum_{\rho \in (T_s)_{\text{int}}} (\# \text{in}(\rho) - 2).$$

(b) If $n \neq (1)$, the dimension satisfies the inequality $0 \leq d(2T) \leq |n| + r - 3$.

Proof (a) Equation (18) is the result of substituting (8) into (17) and the identity

$$(19) \quad \sum_{\alpha \in V_{\text{seam}}(T_b)} \# \text{in}(\alpha) = \#V_{\text{comp}}(T_b) + |n| - 1.$$

This follows by noting that $\sum_{\alpha \in V_{\text{seam}}(T_b)} \# \text{in}(\alpha)$ counts the elements of $V_{\text{comp}}(T_b)$ that are the incoming neighbor of some element of $V_{\text{seam}}(T_b)$. This set is the complement of the root of T_b , hence has cardinality $\#V_{\text{comp}}(T_b) + |n| - 1$.

(b) The inequality $d(2T) \geq 0$ follows from (18) and the STABILITY axiom in the definition of stable tree-pairs; the inequality $d(2T) \leq |n| + r - 3$ follows immediately from (17). □

Next we define three types of “moves” that can be performed on stable tree-pairs. Examples of these moves are shown in Example 3.6. As we will show, each move decreases the dimension d by one.

Fix a stable tree-pair $T_b \xrightarrow{f} T_s$. Here are the moves that may be applied:

- **Type-1 moves** Fix $\alpha \in V_{\text{comp}}(T_b)$ and $\beta \in \text{in}(\alpha)$. Choose a consecutive subset $(\gamma_{p+1}, \dots, \gamma_{p+l}) \subset (\gamma_1, \dots, \gamma_k) = \text{in}(\beta)$ where l satisfies the following condition (necessary to preserve stability):

- If $\#\text{in}(\alpha) = 1$, then we require $2 \leq l < k$.
- If $\#\text{in}(\alpha) \geq 2$, then we require $2 \leq l \leq k$.

The corresponding type-1 move consists of modifying the incoming edges of β as shown here:

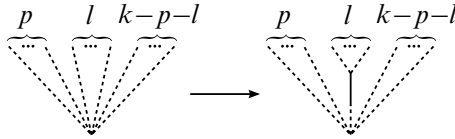

leaving T_s unchanged, and modifying f in the obvious way.

- **Type-2 moves** Fix $\alpha \in V_{\text{comp}}(T_s)$. Choose a consecutive subset $(\gamma_{p+1}, \dots, \gamma_{p+l})$ of $(\gamma_1, \dots, \gamma_k) = \text{in}(\alpha)$, where l satisfies $2 \leq l < k$. For every $\tilde{\alpha} \in V_{\text{comp}}^{\geq 2}(T_b) \cap f^{-1}\{\alpha\}$ with $\text{in}(\tilde{\alpha}) =: (\beta_1, \dots, \beta_k)$ and for every i with $1 \leq i \leq l$, choose $q \geq 0$ and partition $\mathbf{a} := (\#\text{in}(\beta_{p+i}))_{i=1}^l$ as $\mathbf{a} = \sum_{j=1}^q \mathbf{b}^j$, for $\mathbf{b}^1, \dots, \mathbf{b}^q \in \mathbb{Z}^l \setminus \{\mathbf{0}\}$. The corresponding type-2 move consists of modifying the incoming edges of α as shown here:

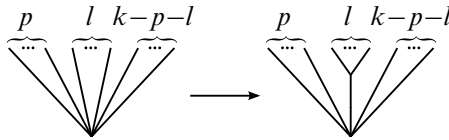

and modifying the incoming edges of each $\tilde{\alpha}$ as shown here:

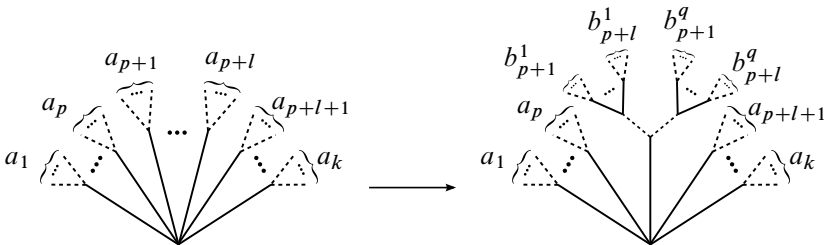

and modifying f in the obvious way.

- Type-3 moves** Choose a vertex $\alpha \in V_{\text{comp}}^{\geq 2}(T_b)$ and write $\text{in}(\alpha) =: \{\beta_1, \dots, \beta_k\}$. Choose $q \geq 2$, and partition $\mathbf{a} := (\#\text{in}(\beta_i))_{i=1}^k$ as $\mathbf{a} = \sum_{j=1}^q \mathbf{b}^j$, for $\mathbf{b}^1, \dots, \mathbf{b}^q$ in $\mathbb{Z}^k \setminus \{\mathbf{0}\}$. The corresponding type-3 move consists of modifying the incoming edges of α as shown here:

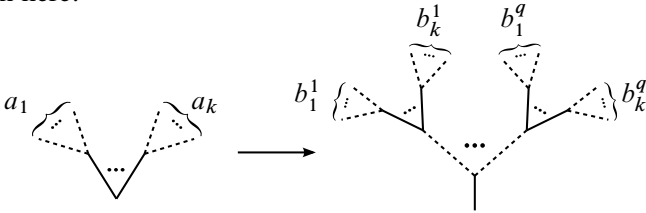

leaving T_s unchanged, and modifying f in the obvious way.

Example 3.6 In Figure 9, we illustrate the moves just introduced. On the left are the eleven tree-pairs comprising W_{200}^{tree} , suggestively overlaid on a pentagon, which encodes the poset structure defined just below. The three moves which we illustrate here can be thought of, respectively, as going from the interior of the pentagon to the bottom red edge, from the interior to the upper-right blue edge, and from the upper-right blue edge to the top mauve vertex. On the right we illustrate these moves, with the numbers for the type of move labeling the arrows corresponding to the moves. We color the portions of the tree-pairs which have been altered by the move. \triangle

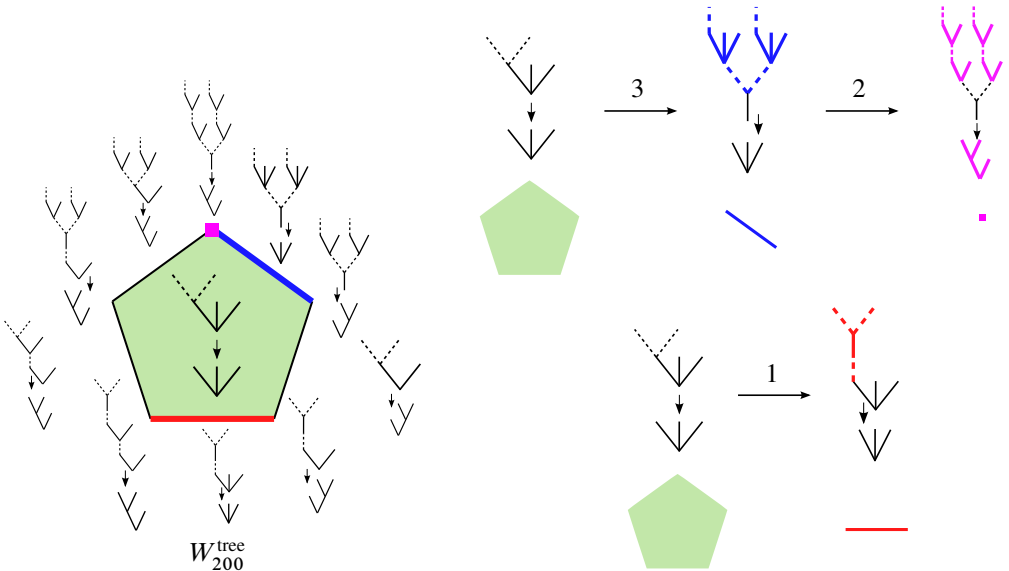

Figure 9

Lemma 3.7 *If $2T'$ is the result of making a move of type 1, 2 or 3 to $2T$, then $d(2T') = d(2T) - 1$.*

Proof Recall the definition of d ,

$$(20) \quad |n| + r - \#V_{\text{comp}}^1(T_b) - \#(T_s)_{\text{int}} - 2.$$

- In a type-1 move, one 1-seam component forms (where the points collide) and T_s does not change.
- In a type-2 move, no new 1-seam components form; one new interior vertex in T_s forms.
- In a type-3 move, one 1-seam component forms (the former k -seam component) and the seam tree does not change. □

Definition 3.8 Define W_n^{tree} as a poset by declaring $2T' < 2T$ if there is a finite sequence of moves that transforms $2T$ into $2T'$. The poset structure is well-defined by the same argument as in [Definition–Lemma 2.9](#). △

Lemma 3.9 *For any $n \geq 1$, there is a poset isomorphism $W_n^{\text{tree}} \simeq K_n^{\text{tree}}$. There are also isomorphisms $W_{n,0}^{\text{tree}} \simeq J_n \simeq W_{0,n}^{\text{tree}}$, where J_n is the $(n-1)$ -dimensional multiplihedron.*

Proof Define a map $W_n^{\text{tree}} \rightarrow K_n^{\text{tree}}$ like so: given a stable tree-pair $T_b \xrightarrow{f} T_s$, send it to the result of collapsing all the solid edges in T_b , then converting all the dashed edges to solid ones. A straightforward check shows that this map is well-defined and respects the partial order. An inverse $K_n^{\text{tree}} \rightarrow W_n^{\text{tree}}$ is given like so: given a stable RRT T , convert its edges to dashed ones, then insert a solid edge at every interior vertex. Here is an illustration of this correspondence, where the stable tree-pair on the left lies in W_6^{tree} and the RRT on the right lies in K_6^{tree} :

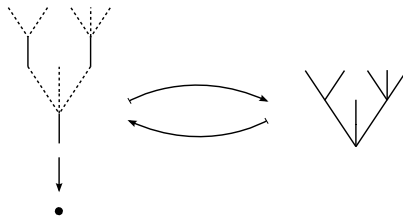

The identifications $W_{n,0}^{\text{tree}} \simeq J_n \simeq W_{0,n}^{\text{tree}}$ are explained in Remark 4.4 of [\[4\]](#). □

Remark 3.10 There are also poset isomorphisms

$$W_{\underbrace{0, \dots, 0, 1, 0, \dots, 0}_n}^{\text{tree}} \simeq K_n^{\text{tree}};$$

we leave the details of these isomorphisms to the reader. △

3.2 The poset W_n^{br} of 2-bracketings

We now define the notion of a 2-bracketing, which will allow us to define the model W_n^{br} . These definitions are somewhat opaque, so we give some motivation after the definitions.

Definition 3.11 A 2-bracket of n is a pair $\mathbf{2B} = (B, (2B_i))$ consisting of a 1-bracket $B \subset \{1, \dots, r\}$ and a consecutive subset $2B_i \subset \{1, \dots, n_i\}$ for every $i \in B$ such that at least one $2B_i$ is nonempty. We write $\mathbf{2B}' \subset \mathbf{2B}$ if $B' \subset B$ and $2B'_i \subset 2B_i$ for every $i \in B'$, and we define $\pi(B, (2B_i)) := B$. △

Definition 3.12 A 2-bracketing of n is a pair $(\mathfrak{B}, 2\mathfrak{B})$, where \mathfrak{B} is a 1-bracketing of r and $2\mathfrak{B}$ is a collection of 2-brackets of n that satisfies these properties:

- **1-BRACKETING** For every $\mathbf{2B} \in 2\mathfrak{B}$, the image $\pi(\mathbf{2B})$ is contained in \mathfrak{B} .
- **2-BRACKETING** Suppose that $\mathbf{2B}, \mathbf{2B}'$ are elements of $2\mathfrak{B}$, and that for some $i_0 \in \pi(\mathbf{2B}) \cap \pi(\mathbf{2B}')$, the intersection $2B_{i_0} \cap 2B'_{i_0}$ is nonempty. Then either $\mathbf{2B} \subset \mathbf{2B}'$ or $\mathbf{2B}' \subset \mathbf{2B}$.
- **ROOT AND MARKED POINTS** $2\mathfrak{B}$ contains

$$(\{1, \dots, r\}, (\{1, \dots, n_1\}, \dots, \{1, \dots, n_r\}))$$

and every 2-bracket of n of the form $(\{i\}, (\{j\}))$.

For any $B_0 \in \mathfrak{B}$, write $2\mathfrak{B}_{B_0} := \{(B, (2B_i)) \in 2\mathfrak{B} \mid B = B_0\}$.

- **MARKED SEAMS ARE UNFUSED**
 - For any $B_0 \in \mathfrak{B}$ and for any $i \in B_0$, we have $\bigcup_{\mathbf{2B} \in 2\mathfrak{B}_{B_0}} 2B_i = \{1, \dots, n_i\}$.
 - For every $\mathbf{2B} \in 2\mathfrak{B}_{B_0}$ for which there exists $\mathbf{2B}' \in 2\mathfrak{B}_{B_0}$ with $\mathbf{2B}' \subsetneq \mathbf{2B}$, and for every $i \in B_0$ and $j \in 2B_i$, there exists $\mathbf{2B}'' \in 2\mathfrak{B}_{B_0}$ with $\mathbf{2B}'' \subsetneq \mathbf{2B}$ and $2B''_i \ni j$.

• **PARTIAL ORDER** For every $B_0 \in \mathfrak{B}$, the set $2\mathfrak{B}_{B_0}$ is endowed with a partial order with the following properties:

- $2\mathbf{B}, 2\mathbf{B}' \in 2\mathfrak{B}_{B_0}$ are comparable if and only if $2B_i \cap 2B'_i = \emptyset$ for every $i \in B_0$.
- For any i and $j < j'$, we have $(\{i\}, (\{j\})) < (\{i\}, (\{j'\}))$.
- For any 2-brackets $2\mathbf{B}^j \in 2\mathfrak{B}_{B_0}, \widetilde{2\mathbf{B}}^j \in 2\mathfrak{B}_{\widetilde{B}_0}, j \in \{1, 2\}$ with $\widetilde{2\mathbf{B}}^j \subset 2\mathbf{B}^j$, we have the implication

$$(21) \quad 2\mathbf{B}^1 < 2\mathbf{B}^2 \implies \widetilde{2\mathbf{B}}^1 < \widetilde{2\mathbf{B}}^2.$$

We define W_n^{br} to be the set of 2-bracketings of n , with the poset structure defined by declaring $(\mathfrak{B}', 2\mathfrak{B}') < (\mathfrak{B}, 2\mathfrak{B})$ if the containments $\mathfrak{B}' \supset \mathfrak{B}, 2\mathfrak{B}' \supset 2\mathfrak{B}$ hold and at least one of these containments is proper. △

Example 3.13 Define a 2-bracketing $(\mathfrak{B}, 2\mathfrak{B}) \in W_{11410}^{\text{br}}$ by

$$(22) \quad \begin{aligned} \mathfrak{B} &:= \{(1), (2), (3), (4), (5), (1, 2), (3, 4, 5), (1, 2, 3, 4, 5)\}, \\ 2\mathfrak{B} &:= \left\{ \begin{aligned} &((1), ((a))), ((2), ((b))), ((3), ((c))), ((3), ((d))), \\ &((3), ((e))), ((3), ((f))), ((4), ((g))), ((1, 2), ((a), 0)), \\ &((1, 2), (0, (b))), ((1, 2), ((a), (b))), ((3, 4, 5), ((c), (g), 0)), \\ &((3, 4, 5), ((d), 0, 0)), ((3, 4, 5), ((f, e), 0, 0)), \\ &((1, 2, 3, 4, 5), ((a), (b), (c), (g), 0)), \\ &((1, 2, 3, 4, 5), (0, 0, (f, e, d), 0, 0)), \\ &((1, 2, 3, 4, 5), ((a), (b), (f, e, d, c), (g), 0)) \end{aligned} \right\}, \end{aligned}$$

subject to the partial orders defined by the following relations:

$$(23) \quad \begin{aligned} &((3), ((f))) < ((3), ((e))) < ((3), ((d))) < ((3), ((c))), \\ &((1, 2), ((a), 0)) < ((1, 2), (0, (b))), \\ &((3, 4, 5), ((f, e), 0, 0)) < ((3, 4, 5), ((d), 0, 0)) < ((3, 4, 5), ((c), (g), 0)), \\ &((1, 2, 3, 4, 5), (0, 0, (f, e, d), 0, 0)) < ((1, 2, 3, 4, 5), ((a), (b), (c), (g), 0)). \end{aligned}$$

Here each 2-bracket $(B, (2B_i))$ denotes $2B_i$ as a subsequence of $(a), (b), (f, e, d, c)$, or (g) , for $i = 1, 2, 3, 4, 5$; this alternative notation is easier to parse in examples.

The presentation of $(\mathcal{B}, 2\mathcal{B})$ just given is obviously cumbersome. It is more convenient to depict 2-bracketings in the following pictorial format:

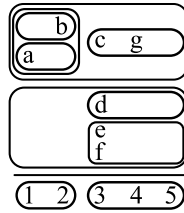

The 1-brackets in \mathcal{B} are shown on the bottom row. The 2-brackets are shown above the dividing line. It is important to note that the 2-brackets come with a width, which indicates the 1-brackets they map to under π , and this is incorporated in the picture. Moreover, the partial orders are reflected as follows: for $2\mathcal{B}_1, 2\mathcal{B}_2 \in 2\mathcal{B}_{\mathcal{B}_0}$, the inequality $2\mathcal{B}_1 > 2\mathcal{B}_2$ holds if and only if $2\mathcal{B}_1$ appears above $2\mathcal{B}_2$. We have not shown the 1-bracket $(1, 2, 3, 4, 5)$, the 2-bracket $((1, 2, 3, 4, 5), ((a), (b), (f, e, d, c), (g), ()))$, or the 1-brackets (resp. 2-brackets) of the form (i) (resp. $((i), ((j)))$): these must be included in $(\mathcal{B}, 2\mathcal{B})$ according to the ROOTS AND LEAVES axiom, so it would not add any information to include them in the picture. \triangle

Example 3.14 In this example, we discuss several invalid variants of the (valid) 2-bracketing from the last example. Consider the five supposed 2-bracketings in the following figure:

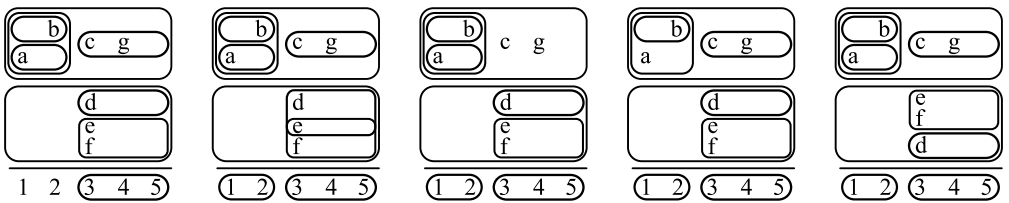

Here is why these are invalid 2-bracketings, from left to right:

- We have deleted $(1, 2)$ from \mathcal{B} . As a result, 1-BRACKETING is not satisfied.
- We have modified $2\mathcal{B}$ by replacing $((3, 4, 5), ((d), (0), (0)))$ with

$$((3, 4, 5), ((e, d), (0), (0))).$$

As a result, 2-BRACKETING is not satisfied.

- Here we have removed the 2-bracket $((3, 4, 5), ((c), (g), (0)))$ from $2\mathcal{B}$. As a result, we have

$$(24) \quad \bigcup_{2\mathbf{B} \in 2\mathcal{B}_{(3,4,5)}} 2B_3 = (f, e, d) \subsetneq (f, e, d, c), \quad \bigcup_{2\mathbf{B} \in 2\mathcal{B}_{(3,4,5)}} 2B_4 = 0 \subsetneq (g),$$

so the first part of MARKED SEAMS ARE UNFUSED is violated.

- We have removed $((1, 2), ((a), (0)))$ from $2\mathcal{B}$. This violates the second part of MARKED SEAMS ARE UNFUSED: in the notation of that condition, set

$$2\mathbf{B} := ((1, 2), ((a), (b))), \quad 2\mathbf{B}' := ((1, 2), ((0), (b))), \quad i := 1, \quad j := a.$$

- In the fifth nonexample, we have modified the partial order on $2\mathcal{B}_{(1,2,3,4,5)}$ by declaring

$$(25) \quad ((3, 4, 5), ((d), (0), (0))) < ((3, 4, 5), ((f, e), (0), (0))) < ((3, 4, 5), ((c), (g), (0))).$$

This, together with the inequality $((3), ((e))) < ((3), ((d)))$, contradicts the third part of PARTIAL ORDER. △

Remark 3.15 (motivation for the definition of 2-bracketings) Recall from [Section 1.1](#) that a 2-bracketing is intended to indicate the bubbling structure of a nodal witch curve. That is, the 1-bracketing \mathcal{B} indicates how the seams have collided; each 2-bracket $2\mathbf{B} \in 2\mathcal{B}$ corresponds to a bubble in the nodal witch curve, with $\pi(2\mathbf{B})$ indicating the seams present on the bubble and the fashion in which these seams have collided, and $2B_i$ indicating the marked points which appear on the i^{th} seam and which are either on the present bubble or appear above this bubble (ie further from the main component). The properties 1-BRACKETING, 2-BRACKETING and ROOT AND MARKED POINTS are straightforward enough: 1-BRACKETING says that the collisions of seams on the various bubbles in the tree are controlled by a single 1-bracketing; 2-BRACKETING says that if a single marked point appears above two different bubbles, then one of these bubbles must be above the other; and ROOT AND MARKED POINTS is a consequence of the fact that the root corresponds to the 2-bracket $(\{1, \dots, r\}, (\{1, \dots, n_1\}, \dots, \{1, \dots, n_r\}))$ and that the j^{th} marked point on the i^{th} seam corresponds to the 2-bracket $(\{i\}, (\{j\}))$. MARKED SEAMS ARE UNFUSED guarantees that marked points may only appear on unfused seams, which is a result of the fact that in our putative compactification $\overline{2\mathcal{M}}_n$, when a collection of seams collide, wherever there is a marked point at the instant of this collision, a bubble must form. Finally, PARTIAL ORDER reflects the fact that in a bubble tree, on each seam of each bubble there is an ordering of the marked and nodal points. △

3.3 We prove that W_n^{tree} and W_n^{br} coincide

In this subsection we finally define W_n , as well as the forgetful map $W_n \rightarrow K_r$.

Definition–Lemma 3.16 Set $W_n := W_n^{\text{tree}} = W_n^{\text{br}}$. The forgetful map $\pi: W_n \rightarrow K_r$ is defined in the two models as follows: $\pi^{\text{tree}}: W_n^{\text{tree}} \rightarrow K_r^{\text{tree}}$ sends $T_b \xrightarrow{f} T_s$ to T_s , and $\pi^{\text{br}}: W_n^{\text{br}} \rightarrow K_r^{\text{br}}$ sends $(\mathfrak{B}, 2\mathfrak{B})$ to \mathfrak{B} .

Proof We need to show that W_n^{tree} and W_n^{br} are isomorphic posets, and that this isomorphism intertwines π^{tree} and π^{br} . The isomorphism $W_n^{\text{tree}} \simeq W_n^{\text{br}}$ is exactly the content of [Theorem 3.17](#) below, and it is evident from the definition of this isomorphism that the two forgetful maps are intertwined. □

We now turn to the proof of the main theorem of this section.

Theorem 3.17 (equivalence of the two models for W_n) *The posets W_n^{tree} and W_n^{br} are isomorphic for any $r \geq 1$ and $n \in \mathbb{Z}_{\geq 0}^r \setminus \{0\}$.*

Proof We construct a bijection $2\nu: W_n^{\text{tree}} \rightarrow W_n^{\text{br}}$ in [Definition–Lemma 3.19](#) and show that it respects the partial orders in [Lemma 3.21](#). □

The notion of a $2T$ -bracket will be central in the construction of $2\nu: W_n^{\text{tree}} \rightarrow W_n^{\text{br}}$ in [Definition–Lemma 3.19](#).

Definition 3.18 Fix a stable tree-pair $2T = T_b \xrightarrow{f} T_s \in W_n^{\text{tree}}$. A $2T$ -bracket is a 2-bracket $2\mathbf{B} = (B, (2B_i))$ of n such that for some $\alpha \in V_{\text{comp}}(T_b) \sqcup V_{\text{mark}}(T_b)$,

$$(26) \quad B = B(f(\alpha)), \quad 2B_i = \{j \mid \mu_{ij}^{T_b} \in (T_s)_\alpha\}.$$

We denote this bracket by $2\mathbf{B}(\alpha) = (B(f(\alpha)), (2B_i(\alpha)))$. △

Note that STABILITY implies that $\alpha \in V_{\text{comp}}(T_b) \sqcup V_{\text{mark}}(T_b)$ is uniquely determined by $2\mathbf{B}(\alpha)$. We denote the vertex corresponding to $2\mathbf{B}$ by $\alpha(2\mathbf{B})$.

With this preparation, we are now ready to define the bijection $2\nu: W_n^{\text{tree}} \rightarrow W_n^{\text{br}}$. This definition is rather technical, so we advise the reader to consult [Example 3.20](#) while reading this definition.

Definition–Lemma 3.19 Define a map $2\nu: W_n^{\text{tree}} \rightarrow W_n^{\text{br}}$ to send a stable tree-pair $2T = T_b \xrightarrow{f} T_s$ to $(\mathfrak{B}(2T), 2\mathfrak{B}(2T))$, where $\mathfrak{B}(2T) := \nu(T_s)$ and $2\mathfrak{B}(2T)$ is the set of $2T$ -brackets, with the partial order on $2\mathfrak{B}(2T)_{B(\beta)}$, for $\beta \in T_s$, defined as follows.

Fix

$$\tilde{\beta}_1, \tilde{\beta}_2 \in (V_{\text{comp}}(T_b) \sqcup V_{\text{mark}}(T_b)) \cap f^{-1}\{\beta\}.$$

If $2\mathbf{B}(\tilde{\beta}_1)$ and $2\mathbf{B}(\tilde{\beta}_2)$ have $2B_i(\tilde{\beta}_1) \cap 2B_i(\tilde{\beta}_2) \neq \emptyset$ for some $i \in B(\beta)$, define $2\mathbf{B}(\tilde{\beta}_1)$ and $2\mathbf{B}(\tilde{\beta}_2)$ to be incomparable. Otherwise, define

$$(27) \quad \gamma := \alpha(\alpha_{\text{root}}^{T_b}, \tilde{\beta}_1, \tilde{\beta}_2) := [\alpha_{\text{root}}^{T_b}, \tilde{\beta}_1] \cap [\tilde{\beta}_1, \tilde{\beta}_2] \cap [\tilde{\beta}_2, \alpha_{\text{root}}^{T_b}] \in V_{\text{seam}}(T_b)$$

as in [6, Section D.2], and for $j \in \{1, 2\}$, define δ_j to be the element of $\text{in}(\gamma)$ such that $\tilde{\beta}_j \in (T_b)_{\gamma\delta_j}$. Now define the order on $2\mathbf{B}(\tilde{\beta}_1), 2\mathbf{B}(\tilde{\beta}_2) \in 2\mathfrak{B}(2T)_{B(\beta)}$ like so:

- If $\delta_1 <_{\gamma} \delta_2$, then $2\mathbf{B}(\tilde{\beta}_1) < 2\mathbf{B}(\tilde{\beta}_2)$.
- If $\delta_2 <_{\gamma} \delta_1$, then $2\mathbf{B}(\tilde{\beta}_2) < 2\mathbf{B}(\tilde{\beta}_1)$.

Then 2ν is bijective.

Proof Throughout this proof we assume $n \neq (1)$, since in this case the bijectivity of 2ν holds trivially.

Step 1 If T is an RRT and β_1 and β_2 are any distinct nonroot vertices, then

$$(28) \quad \gamma := \alpha(\alpha_{\text{root}}, \beta_1, \beta_2) := [\alpha_{\text{root}}, \beta_1] \cap [\beta_1, \beta_2] \cap [\beta_2, \alpha_{\text{root}}]$$

is the node furthest from the root satisfying $\beta_1, \beta_2 \in T_{\gamma}$.

Define Σ to consist of those vertices δ of T satisfying $\beta_1, \beta_2 \in T_{\delta}$. The inclusion $\gamma \in [\alpha_{\text{root}}, \beta_j]$ for $j \in \{1, 2\}$ implies $\beta_j \in T_{\gamma}$, so γ is an element of Σ . Any two elements $\delta_1, \delta_2 \in \Sigma$ have the property that either $\delta_1 \in [\delta_2, \alpha_{\text{root}}]$ or $\delta_2 \in [\delta_1, \alpha_{\text{root}}]$, since both δ_1 and δ_2 lie in $[\alpha_{\text{root}}, \beta_1]$. Suppose that δ_1 and δ_2 are distinct elements of Σ and that δ_1 lies in $[\delta_2, \alpha_{\text{root}}]$. Since β_1 and β_2 lie in T_{δ_1} and δ_1 lies in $[\delta_2, \alpha_{\text{root}}]$, any path from β_1 to β_2 that passes through δ_1 must pass through δ_2 more than once; therefore δ_1 does not lie in $[\beta_1, \beta_2]$, which implies $\gamma \neq \delta_1$. It follows that γ is the (unique) element of Σ that is furthest from the root.

Step 2 If $2T$ is a stable tree-pair of type n , then $2\nu(2T)$ is a 2-bracketing of n .

As discussed in the proof of Proposition 2.13, $\mathfrak{B}(2T) = \nu(T_s)$ is a 1-bracketing of r . For any $(B, (2B_i)) \in 2\mathfrak{B}(2T)$, it is clear that $2B_i \subset \{1, \dots, n_i\}$ is consecutive for every i . The STABILITY axiom implies that there exists i for which $2B_i$ is nonempty, so every element of $2\mathfrak{B}(2T)$ is a 2-bracket.

Next, we justify two implicit assertions in the definition of $(\mathcal{B}(2T), 2\mathcal{B}(2T))$. Specifically, we implicitly asserted that

- (i) for $\beta \in V(T_s)$ and $\tilde{\beta}_1, \tilde{\beta}_2 \in (V_{\text{comp}}(T_b) \sqcup V_{\text{mark}}(T_b)) \cap f^{-1}\{\beta\}$ with the property that $2\mathcal{B}_i(\tilde{\beta}_1) \cap 2\mathcal{B}_i(\tilde{\beta}_2) = \emptyset$ for every $i \in \mathcal{B}(\beta)$, $\gamma := \alpha(\alpha_{\text{root}}^{T_b}, \tilde{\beta}_1, \tilde{\beta}_2)$ lies in $V_{\text{seam}}(T_b)$; and
- (ii) we have defined a partial order on every $2\mathcal{B}(2T)_{\mathcal{B}(\beta)}$.

(i) Suppose for the sake of contradiction that $\gamma \in V_{\text{comp}}(T_b) \sqcup V_{\text{mark}}(T_b)$. Recall from Step 1 that γ can be interpreted as the node furthest from the root with $\tilde{\beta}_1, \tilde{\beta}_2 \in (T_b)_\gamma$. The assumption on $\tilde{\beta}_1$ and $\tilde{\beta}_2$ implies that they are not the same vertex, hence γ cannot lie in $V_{\text{mark}}(T_b)$; therefore $\gamma \in V_{\text{comp}}(T_b)$. For $j \in \{1, 2\}$, define ϵ_j to be the element of $\text{in}(\gamma)$ with $\tilde{\beta}_j \in (T_b)_{\gamma\epsilon_j}$. By the definition of γ , the elements ϵ_1 and ϵ_2 cannot coincide. In particular, $\#\text{in}(\gamma) \geq 2$, so f must map the incoming edges of γ bijectively onto the incoming edges of $f(\gamma)$. Therefore $f(\epsilon_1)$ and $f(\epsilon_2)$ are distinct elements of $\text{in}(f(\gamma))$. A given edge in T_b is either contracted by f or mapped to an edge in an orientation-preserving fashion, so we must have $f(\tilde{\beta}_1) \neq f(\tilde{\beta}_2)$, in contradiction to the assumption $f(\tilde{\beta}_1) = \beta = f(\tilde{\beta}_2)$. Therefore our implicit assertion $\gamma \in V_{\text{seam}}(T_b)$ was justified.

(ii) If $2\mathcal{B}_i(\tilde{\beta}_1) \cap 2\mathcal{B}_i(\tilde{\beta}_2) = \emptyset$ for every $i \in \mathcal{B}(\beta)$, then $\tilde{\beta}_1$ and $\tilde{\beta}_2$ must be distinct; therefore our relation is antireflexive. Next, fix $\tilde{\beta}_1, \tilde{\beta}_2, \tilde{\beta}_3$ with $2\mathcal{B}(\tilde{\beta}_1) < 2\mathcal{B}(\tilde{\beta}_2)$ and $2\mathcal{B}(\tilde{\beta}_2) < 2\mathcal{B}(\tilde{\beta}_3)$. Define

$$(29) \quad \gamma_{ij} := \alpha(\alpha_{\text{root}}^{T_b}, \tilde{\beta}_i, \tilde{\beta}_j), \quad i, j \in \{1, 2, 3\}.$$

Then either (a) $\gamma_{13} = \gamma_{12}$ and $\gamma_{23} \in (T_b)_{\gamma_{13}}$, or (b) $\gamma_{13} = \gamma_{23}$ and $\gamma_{12} \in (T_b)_{\gamma_{13}}$. (Indeed, γ_{12} and γ_{23} are both in $[\tilde{\beta}_2, \alpha_{\text{root}}^{T_b}]$, so either $\gamma_{12} \in (T_b)_{\gamma_{23}}$ or $\gamma_{23} \in (T_b)_{\gamma_{12}}$. Suppose $\gamma_{12} \in (T_b)_{\gamma_{23}}$. Then $\tilde{\beta}_1, \tilde{\beta}_3 \in (T_b)_{\gamma_{23}}$. Moreover, γ_{23} is the furthest vertex from the root with this property: if there exists $\zeta \in \text{in}(\gamma_{23})$ such that $(T_b)_\zeta$ contains $\tilde{\beta}_1$ and $\tilde{\beta}_3$, then $(T_b)_\zeta$ also contains γ_{12} and therefore $\tilde{\beta}_2$, contradicting the fact that γ_{23} is the furthest vertex from the root with $\tilde{\beta}_2, \tilde{\beta}_3 \in (T_b)_{\gamma_{23}}$.) Suppose (a) holds. If $\gamma_{12} = \gamma_{13} = \gamma_{23}$, then there are $\delta_1, \delta_2, \delta_3 \in \text{in}(\gamma_{13})$ with $\tilde{\beta}_j \in (T_b)_{\delta_j}$ for all j . By hypothesis, $\delta_1 <_{\gamma_{13}} \delta_2$ and $\delta_2 <_{\gamma_{13}} \delta_3$, hence $\delta_1 <_{\gamma_{13}} \delta_3$, hence $2\mathcal{B}(\tilde{\beta}_1) < 2\mathcal{B}(\tilde{\beta}_3)$ as desired. On the other hand, suppose (a) holds and $\gamma_{23} \in (T_b)_{\gamma_{13}} \setminus \gamma_{13}$. Define $\delta_1, \delta_{23} \in \text{in}(\gamma_{13})$ by $\tilde{\beta}_1 \in (T_b)_{\delta_1}$, $\gamma_{23} \in (T_b)_{\delta_{23}}$. The hypothesis $2\mathcal{B}(\tilde{\beta}_1) < 2\mathcal{B}(\tilde{\beta}_2)$ implies $\delta_1 <_{\gamma_{13}} \delta_{23}$, and therefore $2\mathcal{B}(\tilde{\beta}_1) < 2\mathcal{B}(\tilde{\beta}_3)$ as desired. A similar argument applies if (b) holds, so our putative partial order is transitive.

Finally, we verify the axioms of a 2-bracketing.

- **1-BRACKETING** Fix $\mathbf{2B} = (B, (2B_i)) \in 2\mathcal{B}(2T)$. Then $\alpha(\mathbf{2B}) \in V_{\text{comp}}(T_b)$ has the property that B is the set of indices of incoming leaves of $f(\alpha)$, which in turn is a 1-bracket in $\mathcal{B}(2T)$; therefore $B \in \mathcal{B}(2T)$.
- **2-BRACKETING** Suppose that $\mathbf{2B}, \mathbf{2B}' \in 2\mathcal{B}(2T)$ have the property that for some $i_0 \in B \cap B'$, $2B_{i_0} \cap 2B'_{i_0} \neq \emptyset$, and denote $\alpha := \alpha(\mathbf{2B}), \alpha' := \alpha(\mathbf{2B}')$. Choose $j \in 2B_{i_0} \cap 2B'_{i_0}$. By assumption, the path from $\mu_{i_0 j}^{T_b}$ to $\alpha_{\text{root}}^{T_b}$ passes through both α and α' , so we must either have $\alpha \in (T_b)_{\alpha'}$ or $\alpha' \in (T_b)_\alpha$. In the first case we must have $\mathbf{2B} \subset \mathbf{2B}'$, and similarly in the second case.
- **ROOT AND MARKED POINTS** Since $f(\alpha_{\text{root}}^{T_b}) = \alpha_{\text{root}}^{T_s}$, the 2-bracket corresponding to $\alpha_{\text{root}}^{T_b}$ is $(\{1, \dots, r\}, (\{1, \dots, n_1\}, \dots, \{1, \dots, n_r\}))$. On the other hand, the 2-bracket corresponding to $\mu_{ij}^{T_b}$ is $(\{i\}, (\{j\}))$.
- **MARKED SEAMS ARE UNFUSED**
 - Fix $\rho \in T_s, i \in B(\rho)$, and $j \in \{1, \dots, n_i\}$; we must produce $\alpha_0 \in V_{\text{comp}}(T_b) \cap f^{-1}\{\rho\}$ with $2B_i(\alpha_0) \ni j$. Choose a path from $\mu_{ij}^{T_b}$ to $\alpha_{\text{root}}^{T_b}$. By examining the image of this path in T_s , we see that some element in the path must lie in $V_{\text{comp}}(T_b) \cap f^{-1}\{\rho\}$, and we can define α_0 to be this element.
 - Fix $B(\rho) \in \mathcal{B}(2T)$; $\mathbf{2B}(\alpha), \mathbf{2B}(\alpha') \in 2\mathcal{B}(2T)_{B(\rho)}$ with $\mathbf{2B}(\alpha') \subsetneq \mathbf{2B}(\alpha)$; $i \in B(\rho)$; and $j \in 2B_i(\alpha) \setminus 2B_i(\alpha')$. We must produce $\mathbf{2B}(\alpha'') \in 2\mathcal{B}_{B(\rho)}$ with $\mathbf{2B}(\alpha'') \subsetneq \mathbf{2B}(\alpha)$ and $2B_i(\alpha'') \ni j$. The containment $\mathbf{2B}(\alpha') \subsetneq \mathbf{2B}(\alpha)$ and the inclusions $\mathbf{2B}(\alpha), \mathbf{2B}(\alpha') \in 2\mathcal{B}(2T)_{B(\rho)}$ imply $\alpha \in V_{\text{comp}}^1(T_b)$. Denote the incoming neighbor of α by β ; we may now choose $\alpha'' \in \text{in}(\beta)$ to have the property that $(T_b)_{\alpha''}$ includes $\mu_{ij}^{T_b}$.
- **PARTIAL ORDER** Earlier we endowed every $2\mathcal{B}_{B(\beta)}, \alpha \in T_s$ with a partial order.
 - It is an immediate consequence of our definition of the partial order on $2\mathcal{B}_{B(\beta)}$ that $\mathbf{2B}(\tilde{\beta}_1), \mathbf{2B}(\tilde{\beta}_2)$ are comparable if and only if $2B_i \cap 2B'_i = \emptyset$ for every $i \in B(\beta)$.
 - For any $i \in \{1, \dots, r\}$ and j, j' with $1 \leq j < j' \leq n_i$, it is clear that $(i, (\{j\})) < (i, (\{j'\}))$ in the partial order on $2\mathcal{B}(2T)_{\{i\}}$.
 - For $j \in \{1, 2\}$, fix $\mathbf{2B}(\alpha^j) \in 2\mathcal{B}(2T)_{B(\rho)}$ and $\mathbf{2B}(\tilde{\alpha}^j) \in 2\mathcal{B}(2T)_{B(\tilde{\rho})}$ with $\mathbf{2B}(\tilde{\alpha}^j) \subset \mathbf{2B}(\alpha^j)$ and $\mathbf{2B}(\alpha^1) < \mathbf{2B}(\alpha^2)$. We must show $\mathbf{2B}(\tilde{\alpha}^1) < \mathbf{2B}(\tilde{\alpha}^2)$. The inclusions $\mathbf{2B}(\tilde{\alpha}^j) \subset \mathbf{2B}(\alpha^j)$ for $j \in \{1, 2\}$ are equivalent to the inclusions $\tilde{\alpha}^j \in (T_b)_{\alpha^j}$. From this it is easy to see that $\mathbf{2B}(\tilde{\alpha}^1) < \mathbf{2B}(\tilde{\alpha}^2)$.

Step 3 We define a putative inverse $2\tau: W_n^{\text{br}} \rightarrow W_n^{\text{tree}}$.

Fix $(\mathcal{B}, 2\mathcal{B}) \in W_n^{\text{br}}$. Define $T_s := \tau(\mathcal{B})$. Towards the definition of T_b , define the sets

$$\begin{aligned}
 V_{\text{mark}} &:= \{(\{i\}, (\{j\})) \mid 1 \leq i \leq r, 1 \leq j \leq n_i\}, \\
 V_{\text{comp}} &:= 2\mathcal{B} \setminus V_{\text{mark}}, \\
 (30) \quad V_{\text{seam}}^1 &:= \{2\mathbf{B} \in 2\mathcal{B} \mid 2\mathbf{B}' \subsetneq 2\mathbf{B} \text{ for some } 2\mathbf{B}' \in 2\mathcal{B}_{\pi(2\mathbf{B})}\}, \\
 V_{\text{seam}}^{\geq 2} &:= \{(2\mathbf{B}, B') \in 2\mathcal{B} \times \mathcal{B} \mid 2\mathbf{B} \notin V_{\text{seam}}^1 \text{ and } B' \in \text{in}(\pi(2\mathbf{B}))\}, \\
 V_{\text{seam}} &:= V_{\text{seam}}^1 \sqcup V_{\text{seam}}^{\geq 2},
 \end{aligned}$$

using the notation $B' \in \text{in}(B)$ as defined in (10). For elements of these sets, we write

$$\mu_{ij}^{T_b} \in V_{\text{mark}}, \quad \alpha_{2\mathbf{B}, \text{comp}} \in V_{\text{comp}}, \quad \alpha_{2\mathbf{B}, \pi(2\mathbf{B}), \text{seam}} \in V_{\text{seam}}^1, \quad \alpha_{2\mathbf{B}, B', \text{seam}} \in V_{\text{seam}}^{\geq 2}.$$

Now define the vertices and incoming neighbors in T_b by

$$\begin{aligned}
 V &:= V_{\text{comp}} \sqcup V_{\text{seam}} \sqcup V_{\text{mark}}, \\
 \alpha_{\text{root}} &:= \alpha(\{1, \dots, r\}, \{\{1, \dots, n_1\}, \dots, \{1, \dots, n_r\}\}),_{\text{comp}}, \\
 \text{in}(\mu_{ij}^{T_b}) &:= \emptyset, \\
 (31) \quad \text{in}(\alpha_{2\mathbf{B}, \text{comp}}) &:= \begin{cases} \{\alpha_{2\mathbf{B}, \pi(2\mathbf{B}), \text{seam}}\} & \text{if } 2\mathbf{B} \in V_{\text{seam}}^1, \\ \{\alpha_{2\mathbf{B}, B', \text{seam}} \mid B' \in \text{in}(\pi(2\mathbf{B}))\} & \text{otherwise,} \end{cases} \\
 \text{in}(\alpha_{2\mathbf{B}, B', \text{seam}}) &:= \{\alpha_{2\mathbf{B}'', \text{comp}} \mid \pi(2\mathbf{B}'') = B', 2\mathbf{B}'' \subsetneq 2\mathbf{B}, 2\mathbf{B}'' \notin V_{\text{seam}}^1\} \\
 &\quad \cup \{\mu_{ij}^{T_b} \mid B' = \{i\}, (\{i\}, (\{j\})) \subsetneq 2\mathbf{B}, \\
 &\quad \exists 2\mathbf{B}'' \in 2\mathcal{B} \text{ such that } (\{i\}, (\{j\})) \subsetneq 2\mathbf{B}'' \subsetneq 2\mathbf{B}\},
 \end{aligned}$$

where the incoming edges of $\alpha_{2\mathbf{B}, \text{comp}}$ are solid and the incoming edges of $\alpha_{2\mathbf{B}, B', \text{seam}}$ are dashed. For $\alpha_{2\mathbf{B}, \text{comp}}$ for which there does not exist $2\mathbf{B}' \in 2\mathcal{B}_{\pi(2\mathbf{B})}$ with $2\mathbf{B}' \subsetneq 2\mathbf{B}$, order the incoming neighbors $\{\alpha_{2\mathbf{B}, B', \text{seam}} \mid B' \in \text{in}(\pi(2\mathbf{B}))\}$ according to the order on the incoming neighbors of $\pi(2\mathbf{B})$ in $T_s = \tau(\mathcal{B})$. For $\alpha_{2\mathbf{B}, B', \text{seam}}$, order the incoming neighbors according to the partial order on $2\mathcal{B}_{\pi(2\mathbf{B})}$. Finally, define $f: T_b \rightarrow T_s$ by

$$(32) \quad f(\mu_{ij}^{T_b}) := \lambda_i^{T_s}, \quad f(\alpha_{2\mathbf{B}, \text{comp}}) := \alpha(\pi(2\mathbf{B})), \quad f(\alpha_{2\mathbf{B}, B', \text{seam}}) := \alpha(B').$$

There are a number of things we have to check in order to verify that $T_b \xrightarrow{f} T_s$ is a stable tree-pair. For (31) to define a RRT via Lemma 2.3, we must check conditions (i)–(iii) in the statement of that lemma.

(i) It is clear that no $\text{in}(\alpha)$ can contain α_{root} .

(ii) Fix a nonroot vertex α in T_b . Depending on which type of vertex α is, we check that there exists a unique β with $\text{in}(\beta) \ni \alpha$:

- $\alpha = \mu_{ij}^{T_b}$ The vertices β with $\text{in}(\beta) \ni \mu_{ij}^{T_b}$ are exactly those $\alpha_{2\mathbf{B},\{i\},\text{seam}}$ with $2\mathbf{B}$ satisfying these properties:

- (a) $(i, (\{j\})) \subsetneq 2\mathbf{B}$;
- (b) either $\pi(2\mathbf{B}) = \{i\}$, or $\pi(2\mathbf{B}) \supsetneq \{i\}$ and no $B'' \in \mathcal{B}$ has $\{i\} \subsetneq B'' \subsetneq \pi(2\mathbf{B})$;
- (c) no $2\mathbf{B}'' \ni 2\mathcal{B}$ has $(i, (\{j\})) \subsetneq 2\mathbf{B}'' \subsetneq 2\mathbf{B}$.

Define Σ to consist of those $2\mathbf{B} \in 2\mathcal{B}$ that properly contain $(i, (\{j\}))$, and order Σ by inclusion. Since α is not the root, Σ contains α_{root} and is therefore not empty; by the 2-BRACKETING property of 2-bracketings, any two elements of Σ are comparable under inclusion. Therefore Σ has a unique minimal element $2\mathbf{B}^0$.

I claim that $2\mathbf{B}^0$ is the unique element of $2\mathcal{B}$ satisfying (a)–(c). Indeed, it is clear from its definition that $2\mathbf{B}^0$ satisfies (a) and (c). If $2\mathbf{B}$ does not satisfy (b), then there exists $B'' \in \mathcal{B}$ with $\{i\} \subsetneq B'' \subsetneq \pi(2\mathbf{B}^0)$. By the MARKED SEAMS ARE UNFUSED property of 2-bracketings, there exists $2\mathbf{B}'' \in 2\mathcal{B}$ with $\pi(2\mathbf{B}'') = B''$ and $2\mathbf{B}''_i \ni j$. This 2-bracket satisfies $(i, (\{j\})) \subsetneq 2\mathbf{B}'' \subsetneq 2\mathbf{B}^0$, which contradicts the definition of $2\mathbf{B}$; therefore $2\mathbf{B}$ satisfies (b). On the other hand, suppose that $2\mathbf{B}$ satisfies (a)–(c). Property (a) implies that $2\mathbf{B}$ lies in Σ , and (c) implies that $2\mathbf{B}$ is in fact the minimal element of Σ ; therefore $2\mathbf{B} = 2\mathbf{B}^0$. We may conclude that $\beta := \alpha_{2\mathbf{B},\{i\},\text{seam}}$ is the unique vertex in T_b with $\text{in}(\beta) \ni \alpha$.

- $\alpha = \alpha_{2\mathbf{B},\text{comp}}$ An argument similar to the one used in the case $\alpha = \mu_{ij}^{T_b}$ shows that there is a unique β with $\text{in}(\beta) \ni \alpha$.

- $\alpha = \alpha_{2\mathbf{B},B',\text{seam}}$ If there exists $2\mathbf{B}'' \in 2\mathcal{B}_{\pi(2\mathbf{B})}$ with $2\mathbf{B}'' \subsetneq 2\mathbf{B}$, then $\alpha \in V_{\text{seam}}^1$ and $B' = \pi(2\mathbf{B})$. Therefore $\beta := \alpha_{2\mathbf{B},\text{comp}}$ is the unique vertex with $\text{in}(\beta) \ni \alpha$.

On the other hand, suppose that there does not exist such a $2\mathbf{B}''$. Then $\alpha \in V_{\text{seam}}^{\geq 2}$, and $\beta := \alpha_{2\mathbf{B},\text{comp}}$ is the unique vertex with $\text{in}(\beta) \ni \alpha$.

(iii) Suppose that $\alpha_1, \dots, \alpha_\ell \in V$ has $\ell \geq 2$ and $\alpha_j \in \text{in}(\alpha_{j+1})$ for every j . It is clear from our verification of (ii) that α_1 is not the same as α_ℓ .

Now that we have shown that T_b is well-defined as an RRT, we check the rest of the requirements on $T_b \xrightarrow{f} T_s$.

- For the bubble tree T_b :
 - We have defined V as the union $V = V_{\text{comp}} \sqcup V_{\text{seam}} \sqcup V_{\text{mark}}$, and the incoming and outgoing edges of the vertices are clearly the necessary type. It is not hard to see that $\alpha_{2\mathbf{B}, \text{comp}} \in V_{\text{comp}}$ has at least one incoming edge: if there exists $2\mathbf{B}' \in 2\mathcal{B}_\pi(2\mathbf{B})$ with $2\mathbf{B}' \subsetneq 2\mathbf{B}$, then $\# \text{in}(\alpha_{2\mathbf{B}, \text{comp}}) = 1$. Next, suppose that there is no such $2\mathbf{B}'$. The incoming vertices of $\alpha_{2\mathbf{B}, \text{comp}}$ are in correspondence with maximal elements of Σ , where Σ consists of those elements B' of \mathcal{B} with $B' \subsetneq \pi(2\mathbf{B})$. It follows from the ROOT AND LEAVES property of 1–bracketings that $\# \text{in}(\alpha_{2\mathbf{B}, \text{comp}}) \geq 2$.

– **STABILITY** Fix $\alpha = \alpha_{2\mathbf{B}, \text{comp}} \in V_{\text{comp}}^1$. Its unique incoming neighbor is the vertex $\beta := \alpha_{2\mathbf{B}, \pi(2\mathbf{B}), \text{seam}}$. We must show that β has at least 2 incoming neighbors. The incoming neighbors of β are in correspondence with the maximal elements of the set Σ of $2\mathbf{B}'' \in 2\mathcal{B}_\pi(2\mathbf{B})$ with $2\mathbf{B}'' \subsetneq 2\mathbf{B}$. The fact that $\alpha_{2\mathbf{B}, \text{comp}}$ lies in V_{comp}^1 implies that Σ is nonempty. Choose $2\mathbf{B}^1$ to be any maximal element of Σ . Now choose any i, j with the property that $2\mathbf{B}_i \setminus \widetilde{2\mathbf{B}}_i$ contains j . Define Σ' to consist of those $2\mathbf{B}'' \in \Sigma$ with $2\mathbf{B}''_i \ni j$. By MARKED SEAMS ARE UNFUSED, Σ' is nonempty; choose $2\mathbf{B}^2$ to be any maximal element of Σ' . Then $2\mathbf{B}^1, 2\mathbf{B}^2$ are distinct maximal elements of Σ . This shows that β has at least 2 incoming neighbors.

On the other hand, suppose that $\alpha = \alpha_{2\mathbf{B}, \text{comp}}$ lies in $V_{\text{comp}}^{\geq 2}$. Write $2\mathbf{B} = (B, (2B_i))$. The incoming neighbors of α are in correspondence with maximal elements of the set Σ of 1–brackets $B' \in \mathcal{B}$ with $B' \subsetneq B$. Not every $2B_i$ can be empty, so we may choose i, j with the property that $2B_i$ contains j . Define Σ' to be the set of 1–brackets $B' \in \mathcal{B}$ with $\{i\} \subset B' \subsetneq B$. The set Σ' contains $\{i\}$, hence is nonempty; define B^1 to be a maximal element of Σ' (in fact, this determines B^1 uniquely). Now define Σ'' to be the set of 2–brackets $2\mathbf{B}'' \in 2\mathcal{B}_{B^1}$ with $(i, (\{j\})) \subset 2\mathbf{B}'' \subsetneq 2\mathbf{B}$. The set Σ'' contains $(i, (\{j\}))$, hence is nonempty; define $2\mathbf{B}^2$ to be a maximal element of Σ'' . Then $\alpha = \alpha_{2\mathbf{B}, \text{comp}}$ has $\beta := \alpha_{2\mathbf{B}, B^1, \text{seam}}$ as an incoming neighbor, and β has $\alpha_{2\mathbf{B}^2, \text{comp}}$ as an incoming neighbor.

- By Proposition 2.13, T_s is an element of K_r^{tree} .
- It is clear that f satisfies the necessary properties.

Step 4 We verify that 2ν and 2τ are inverse to one another.

This follows from an argument similar to the one made in the proof of Proposition 2.13 to show that ν and τ are inverse to one another. □

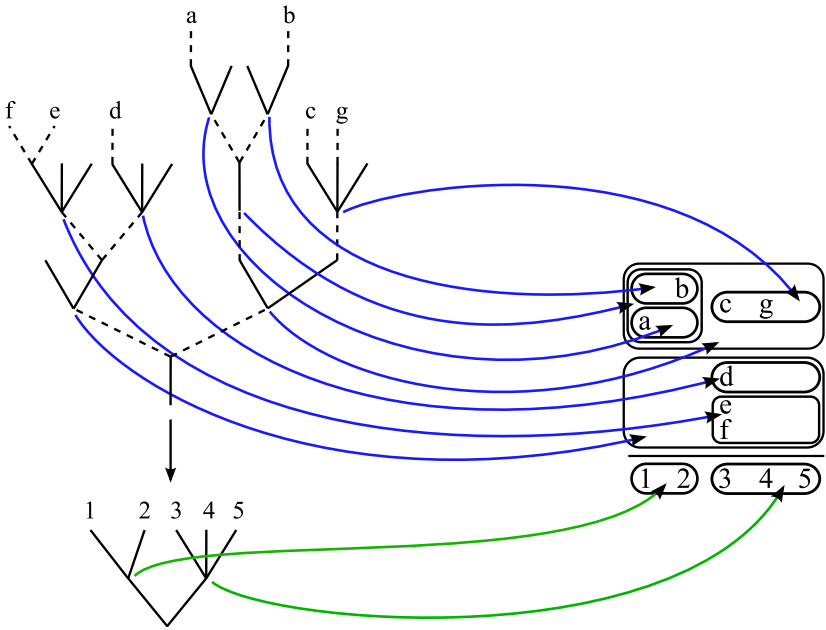

Figure 10: Illustrating the definition of the map 2ν

Example 3.20 In Figure 10, we illustrate the definition of 2ν as a map of sets. On the left is the tree-pair in W_{11410}^{tree} we discussed in Example 3.2, and on the right is the 2-bracketing in W_{11410}^{br} we discussed in Example 3.13. In fact, these objects are identified by 2ν . Indeed, we see here how the elements of $V_{\text{comp}}(T_b) \cup V_{\text{mark}}(T_b)$ are sent to 2-brackets (indicated by blue arrows), and how the elements of T_s are sent to 1-brackets (green arrows). (We have omitted the blue and green arrows corresponding to $\rho_{\text{root}}^{T_s}$, $\alpha_{\text{root}}^{T_b}$, $V_{\text{mark}}(T_b)$ and $T_s \setminus (T_s)_{\text{int}}$.) The procedure for assigning a 2-bracket to an element α of $V_{\text{comp}}(T_b) \cup V_{\text{mark}}(T_b)$ is simple: the 2-bracket includes the elements of $V_{\text{mark}}(T_b)$ lying above α , and the projection of the 2-bracket includes the leaves of T_s above $f(\alpha)$.

In Figure 11 we indicate, in the case of the same tree-pair $2T$, how the partial order on $2\nu(2T)$ is defined. Specifically, we indicate why the inequalities $2\mathbf{B}(\gamma_1) < 2\mathbf{B}(\gamma_2)$, $2\mathbf{B}(\delta_1) < 2\mathbf{B}(\delta_2)$ and $2\mathbf{B}(\epsilon_1) < 2\mathbf{B}(\epsilon_2)$ hold. Here is the procedure, in the case of δ_1 and δ_2 : draw (blue) paths downward from δ_1 and δ_2 , until the paths intersect at a vertex α . At α — necessarily an element of $V_{\text{seam}}(T_b)$ — note which elements of $\text{in}(\alpha)$ the two paths passed through. Using the order on $\text{in}(\alpha)$, we obtain the inequality $2\mathbf{B}(\delta_1) < 2\mathbf{B}(\delta_2)$. \triangle

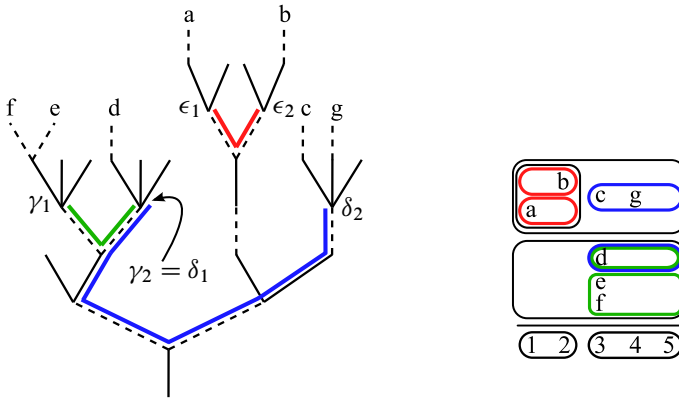

Figure 11: Illustrating the partial order on the image of the map 2ν

In the next lemma, we introduce the notion of a move on a 2-bracketing. We say that $2\mathcal{B}'$ is the result of performing a move on $2\mathcal{B}$ if $(2\nu)^{-1}(2\mathcal{B}')$ is the result of performing a move on $(2\nu)^{-1}(2\mathcal{B})$.

Lemma 3.21 *The partial order on W_n^{br} coincides with the one induced by the partial order on W_n^{tree} and the isomorphism $2\nu: W_n^{\text{tree}} \rightarrow W_n^{\text{br}}$.*

Proof The nontrivial direction is to show that for $(\mathcal{B}^1, 2\mathcal{B}^1) \subsetneq (\mathcal{B}^2, 2\mathcal{B}^2)$, we can obtain $(\mathcal{B}^2, 2\mathcal{B}^2)$ from $(\mathcal{B}^1, 2\mathcal{B}^1)$ via a finite sequence of moves. It is enough to show that there is a 2-bracketing $(\mathcal{B}, 2\mathcal{B}) \in W_n^{\text{br}}$ satisfying the containments

$$(33) \quad (\mathcal{B}^1, 2\mathcal{B}^1) \subset (\mathcal{B}, 2\mathcal{B}) \subset (\mathcal{B}^2, 2\mathcal{B}^2),$$

and such that either $(\mathcal{B}, 2\mathcal{B})$ is the result of performing a single move on $(\mathcal{B}^1, 2\mathcal{B}^1)$, or $(\mathcal{B}^2, 2\mathcal{B}^2)$ is the result of performing a single move on $(\mathcal{B}, 2\mathcal{B})$. We produce such a 2-bracketing in the following, exhaustive, cases.

Case 1 (there exist $B^0 \in \mathcal{B}^1$ and $2\mathbf{B} \in 2\mathcal{B}_{B^0}^2 \setminus 2\mathcal{B}_{B^0}^1$, $2\mathbf{B}' \in 2\mathcal{B}_{B^0}^2$ with $2\mathbf{B}' \subsetneq 2\mathbf{B}$) We claim that $(\mathcal{B}^2, 2\mathcal{B}^2 \setminus \{2\mathbf{B}\})$ is a valid 2-bracketing. The only property that does not obviously hold is MARKED SEAMS ARE UNFUSED. This is a consequence of the fact that $(\mathcal{B}^2, 2\mathcal{B}^2)$ has the MARKED SEAMS ARE UNFUSED property. $(\mathcal{B}^2, 2\mathcal{B}^2)$ is the result of performing a type-1 move on $(\mathcal{B}^2, 2\mathcal{B}^2 \setminus \{2\mathbf{B}\})$, and the necessary containments hold:

$$(34) \quad (\mathcal{B}^1, 2\mathcal{B}^1) \subset (\mathcal{B}^2, 2\mathcal{B}^2 \setminus \{2\mathbf{B}\}) \subsetneq (\mathcal{B}^2, 2\mathcal{B}^2).$$

We illustrate this case in Figure 12. On the left are the 2-bracketings $(\mathcal{B}^1, 2\mathcal{B}^1)$, $(\mathcal{B}, 2\mathcal{B})$, $(\mathcal{B}^2, 2\mathcal{B}^2)$, from left to right; on the right are the tree-pairs corresponding

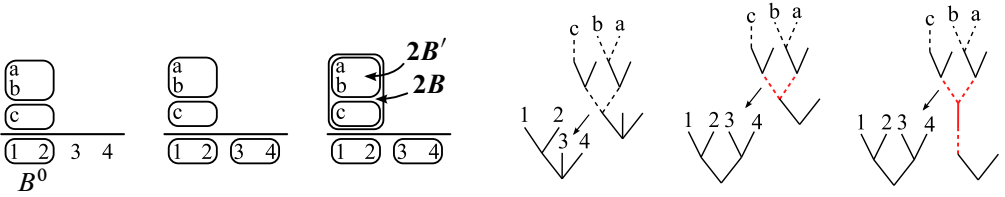

Figure 12: Case 1 in the proof of Lemma 3.21

via 2ν to these 2-bracketings. $(\mathcal{B}^2, 2\mathcal{B}^2)$ is the result of performing a type-1 move on $(\mathcal{B}, 2\mathcal{B})$, and we highlight in red the portion of the tree-pairs involved in this move.

Case 2 (Case 1 does not hold, and there exist $B^0 \in \mathcal{B}^1$ and 2-brackets $2\mathbf{B} \in 2\mathcal{B}_{B^0}^2$, $2\mathbf{B}' \in 2\mathcal{B}_{B^0}^2 \setminus 2\mathcal{B}_{B^0}^1$ with $2\mathbf{B}' \subsetneq 2\mathbf{B}$) Fix such 2-brackets $2\mathbf{B}'$, $2\mathbf{B}$. Without loss of generality, we may assume that $2\mathbf{B}$ is minimal among 2-brackets in $2\mathcal{B}_{B^0}^2$ that properly contain $2\mathbf{B}'$. The assumption that we are not in Case 1 implies that $2\mathbf{B}$ lies in $2\mathcal{B}_{B^0}^1$; this assumption also implies that $2\mathbf{B}'$ cannot properly contain any 2-bracket in $2\mathcal{B}_{B^0}^2$. This and the minimality of $2\mathbf{B}$ implies that for any $i \in B^0$ and $j \in 2B'_i$, there is no $2\mathbf{B}'' \in 2\mathcal{B}_{B^0}^1$ with $2\mathbf{B}'' \subsetneq 2\mathbf{B}$ and $2B''_i \ni j$; it therefore follows from the MARKED SEAMS ARE UNFUSED property of $(\mathcal{B}^1, 2\mathcal{B}^1)$ that there are no 2-brackets in $2\mathcal{B}_{B^0}^1$ that are properly contained in $2\mathbf{B}$. The MARKED SEAMS ARE UNFUSED property of $(\mathcal{B}^2, 2\mathcal{B}^2)$ implies that for every $i \in B^0$ and $j \in 2B_i$, there exists $\widetilde{2\mathbf{B}} \in 2\mathcal{B}_{B^0}^2$ with $\widetilde{2\mathbf{B}} \subsetneq 2\mathbf{B}$ and $\widetilde{2B}_i \ni j$. This, together with 2-BRACKETING, implies that if we let $\widetilde{B}^1, \dots, \widetilde{B}^k \in 2\mathcal{B}_{B^0}^2$ denote the maximal elements of $2\mathcal{B}_{B^0}^2$ (with respect to inclusion) that are properly contained in $2\mathbf{B}$, then these 2-bracketings satisfy $2\mathbf{B} = \bigsqcup_{i=1}^k \widetilde{2\mathbf{B}}^k$. Therefore $(\mathcal{B}^1, 2\mathcal{B}^1 \cup \{\widetilde{2\mathbf{B}}^1, \dots, \widetilde{2\mathbf{B}}^k\})$ is the result of performing a single type-3 move on $(\mathcal{B}^1, 2\mathcal{B}^1)$, and the necessary containments hold:

$$(35) \quad (\mathcal{B}^1, 2\mathcal{B}^1) \subsetneq (\mathcal{B}^1, 2\mathcal{B}^1 \cup \{\widetilde{2\mathbf{B}}^1, \dots, \widetilde{2\mathbf{B}}^k\}) \subset (\mathcal{B}^2, 2\mathcal{B}^2).$$

As in Case 1, we illustrate this procedure in Figure 13. Here we take $B^0 = (1, 2, 3, 4)$, $2\mathbf{B} = ((1, 2, 3, 4), ((c, b, a), (0), (0), (0)))$ and $2\mathbf{B}' = ((1, 2, 3, 4), ((b, a), (0), (0), (0)))$.

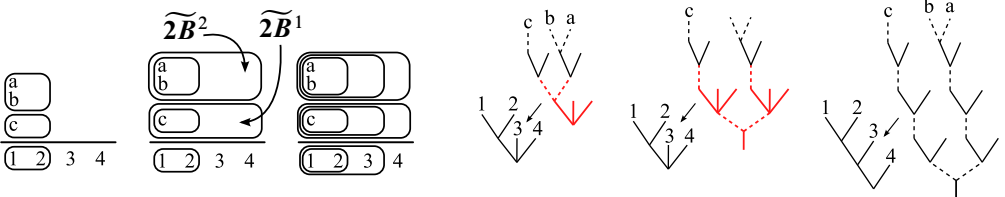

Figure 13: Case 2 in the proof of Lemma 3.21

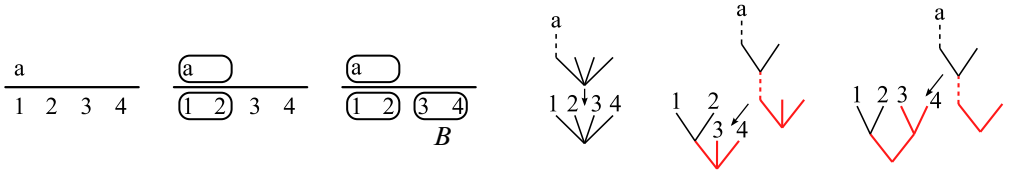

Figure 14: Case 3 in the proof of Lemma 3.21

Case 3 (neither Case 1 nor Case 2 hold) The proper containment $(\mathcal{B}^1, 2\mathcal{B}^1) \subsetneq (\mathcal{B}^2, 2\mathcal{B}^2)$ implies that either $\mathcal{B}^2 \setminus \mathcal{B}^1$ is nonempty or $2\mathcal{B}^2 \setminus 2\mathcal{B}^1$ is nonempty. I claim that under the current assumptions, $\mathcal{B}^2 \setminus \mathcal{B}^1$ must be nonempty. Indeed, suppose that $2\mathcal{B}^2 \setminus 2\mathcal{B}^1$ is nonempty, and choose an element $2\mathbf{B} = (B, (2B_i))$. The assumption that neither Case 1 nor Case 2 hold implies that there is no $2\mathbf{B}' \in 2\mathcal{B}^2_B$ with either $2\mathbf{B}' \subsetneq 2\mathbf{B}$ or $2\mathbf{B} \subsetneq 2\mathbf{B}'$. This, together with the 2-BRACKETING and MARKED SEAMS ARE UNFUSED properties of $(\mathcal{B}^1, 2\mathcal{B}^1)$, implies that B lies in $\mathcal{B}^2 \setminus \mathcal{B}^1$. We may conclude that $\mathcal{B}^2 \setminus \mathcal{B}^1$ is nonempty.

Choose $B \in \mathcal{B}^2 \setminus \mathcal{B}^1$, and note that the assumption that neither Case 1 nor Case 2 hold implies that any two elements of $2\mathcal{B}^2_B$ are disjoint. Set $\mathcal{B} := \mathcal{B}^2 \setminus \{B\}$ and $2\mathcal{B} := 2\mathcal{B}^2 \setminus 2\mathcal{B}^2_B$. Then the necessary containments hold, and $(\mathcal{B}^2, 2\mathcal{B}^2)$ is the result of performing a single type-2 move on $(\mathcal{B}, 2\mathcal{B})$.

As above, we illustrate this case in Figure 14. □

4 Key properties of W_n

Next we establish several properties of W_n , collected in this paper’s main theorem:

Theorem 4.1 (key properties of W_n) For any $r \geq 1$ and $\mathbf{n} \in \mathbb{Z}_{\geq 0}^r \setminus \{\mathbf{0}\}$, the 2-*associahedron* W_n is a poset, the collection of which satisfies the following properties:

- **ABSTRACT POLYTOPE** For $\mathbf{n} \neq (1)$, the poset $\widehat{W}_n := W_n \cup \{F_{-1}\}$ is an abstract polytope of dimension $|\mathbf{n}| + r - 3$.
- **FORGETFUL** W_n is equipped with forgetful maps $\pi: W_n \rightarrow K_r$, which are surjective maps of posets.
- **RECURSIVE** For any stable tree-pair $2T = T_b \xrightarrow{f} T_s \in W_n^{\text{tree}}$, there is an inclusion of posets

$$(36) \quad \Gamma_{2T}: \prod_{\substack{\alpha \in V_{\text{comp}}^1(T_b) \\ \text{in}(\alpha) = (\beta)}} W_{\# \text{in}(\beta)}^{\text{tree}} \times \prod_{\rho \in V_{\text{int}}(T_s)} \prod_{\substack{\alpha \in V_{\text{comp}}^{\geq 2}(T_b) \cap f^{-1}\{\rho\} \\ \text{in}(\alpha) = (\beta_1, \dots, \beta_{\# \text{in}(\rho)})}}^{K_{\# \text{in}(\rho)}} W_{\# \text{in}(\beta_1), \dots, \# \text{in}(\beta_{\# \text{in}(\rho)})}^{\text{tree}} \hookrightarrow W_n^{\text{tree}}$$

where the superscript on one of the product symbols indicates that it is a fiber product with respect to the maps described in FORGETFUL. This inclusion is a poset isomorphism onto $\text{cl}(2T) = (F_{-1}, 2T]$.

Proof We prove the RECURSIVE and ABSTRACT POLYTOPE properties in Definition–Lemma 4.4 and Theorem 4.5, respectively. W_n is a poset by its construction in Definition–Lemma 3.16, and the forgetful map from the same definition is evidently a surjection of posets. □

We now turn to the proof of the RECURSIVE property, which characterizes the closed faces of W_n as products and fiber products of lower-dimensional 2-associahedra. Toward this characterization, we show in the following lemma that for $2T' \in \text{cl}(2T)$, certain vertices in $2T$ have avatars in $2T'$.

Lemma 4.2 Fix $2T, 2T' \in W_n^{\text{tree}}$ with $2T' \leq 2T$.

- For any $\rho \in T_s$, there exists a unique $\rho' \in T'_s$ satisfying $B(\rho') = B(\rho)$.
- For any $\alpha \in V_{\text{comp}}(T_b) \cup V_{\text{mark}}(T_b)$ there exists a unique $\alpha' \in V_{\text{comp}}(T'_b) \cup V_{\text{mark}}(T'_b)$ satisfying $2B(\alpha') = 2B(\alpha)$.

Proof First, we prove the first statement. The uniqueness of ρ' is guaranteed by the stability condition, so it suffices to prove existence. We do so by induction on $d(2T')$, starting with $d(2T') = d(2T)$ and counting down. If $d(2T') = d(2T)$, then $T_s = T'_s$ and the statement holds trivially. Next, suppose that for $\rho \in T_s$, we have proved the existence of $\rho' \in T'_s$ with $B(\rho') = B(\rho)$ for every $2T' \leq 2T$ with $d(2T') \geq d(2T) - k \geq 1$; we must show that there is $\rho' \in T'_s$ with $B(\rho') = B(\rho)$ for $2T' < 2T$ with $d(2T') = d(2T) - k - 1$. Choose $2T''$ with $2T' < 2T'' \leq 2T$ and $d(2T'') = d(2T) - k$, and denote by ρ'' the vertex in T''_s with $B(\rho'') = B(\rho)$. Since $2T'$ can be obtained from $2T''$ via a single move, either $T'_s = T''_s$ or T'_s can be obtained from T''_s by performing the following modification to some solid corolla in T''_s , for $2 \leq \ell < k$:

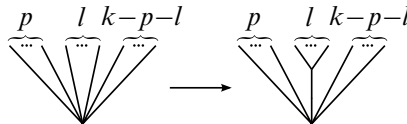

In the former case, set $\rho' := \rho''$. In the latter case, identify $V(T'_s) \simeq V(T''_s) \cup \{v_{\text{new}}\}$; if we set ρ' to be the vertex in T'_s corresponding via this identification to ρ'' , then $B(\rho') = B(\rho'')$.

The second statement of the lemma can be proven similarly. □

Next, we show how this correspondence allows us to extract certain sub-tree-pairs from $2T'$.

Definition–Lemma 4.3 Fix $2T, 2T' \in W_n^{\text{tree}}$ with $2T' < 2T$.

- (a) Fix $\alpha \in V_{\text{comp}}^1(T_b)$ with $\text{in}(\alpha) =: (\beta)$ and $\text{in}(\beta) =: (\gamma_1, \dots, \gamma_k)$, and denote by $\alpha', \gamma'_1, \dots, \gamma'_k$ the vertices in T'_b that correspond to $\alpha, \gamma_1, \dots, \gamma_k$ via Lemma 4.2. Define $(T'_b)^\alpha$ to be the portion of T'_b bounded by α' and $\gamma'_1, \dots, \gamma'_k$, and define $(T'_s)^\alpha$ to be a single vertex. Then $(2T')^\alpha := (T'_b)^\alpha \rightarrow (T'_s)^\alpha$ is a stable tree-pair in W_k^{tree} .
- (b) For any $\rho \in V_{\text{int}}(T_s)$ with $\text{in}(\rho) =: (\sigma_1, \dots, \sigma_k)$, define $(T'_s)^\rho$ to be the portion of T'_s bounded by ρ' and $\sigma'_1, \dots, \sigma'_k$, where we continue to use the notation of Lemma 4.2. For any $\alpha \in V_{\text{comp}}^{\geq 2}(T_b)$ with $f(\alpha) = \rho$, write $\text{in}(\alpha) =: (\beta_1, \dots, \beta_k)$ and $\text{in}(\beta_i) =: (\gamma_{i1}, \dots, \gamma_{i\ell_i})$ for $i \in \{1, \dots, k\}$, and define $(T'_b)^\alpha$ to be the portion of T'_b bounded by α' and $\gamma'_{11}, \dots, \gamma'_{1\ell_1}, \dots, \gamma'_{k1}, \dots, \gamma'_{k\ell_k}$. Then $((T'_s)^\rho, ((2T')^\alpha := (T'_b)^\alpha \rightarrow (T'_s)^\rho)_\alpha)$ is an element of the fiber product

$$(37) \quad \prod_{\substack{\alpha \in V_{\text{comp}}^{\geq 2}(T_b) \cap f^{-1}\{\rho\} \\ \text{in}(\alpha) = (\beta_1, \dots, \beta_k)}}^{K_{\#\text{in}(\rho)}} W_{\ell_1, \dots, \ell_k}^{\text{tree}}$$

Proof (a) The statement that $(2T')^\alpha$ is an element of W_k^{tree} is almost immediate. Indeed, $(T'_s)^\alpha = \text{pt}$, and $(T'_b)^\alpha$ is the following:



Define $2T = \widetilde{2T}^1, \dots, \widetilde{2T}^{a_0} = 2T'$, where $\widetilde{2T}^{a+1}$ can be obtained from $\widetilde{2T}^a$ by making a single move. Then $(\widetilde{T}_s^a)^\alpha = \text{pt}$ for every a , and $(\widetilde{T}_b^{a+1})^\alpha$ is either equal to $(\widetilde{T}_b^a)^\alpha$ or can be obtained from $(\widetilde{T}_b^a)^\alpha$ by performing the following modification to one of the dashed corollas in $(\widetilde{T}_b^a)^\alpha$, for $2 \leq \ell < k$:

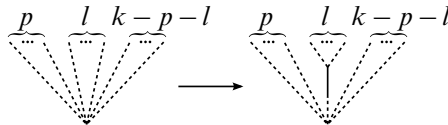

W_k^{tree} is closed under modifications of this form, so $(2T')^\alpha$ is a stable tree-pair in W_k^{tree} .

- (b) This statement can be proven via an argument similar to the one made for (a). \square

We are now ready to establish the RECURSIVE property.

Definition–Lemma 4.4 Fix $2T \in W_n^{\text{tree}}$. Define a map

$$(38) \quad \Gamma_{2T}: \prod_{\substack{\alpha \in V_{\text{comp}}^1(T_b) \\ \text{in}(\alpha) = (\beta)}} W_{\#\text{in}(\beta)}^{\text{tree}} \times \prod_{\rho \in V_{\text{int}}(T_s)} \prod_{\substack{\alpha \in V_{\text{comp}}^{\geq 2}(T_b) \cap f^{-1}\{\rho\} \\ \text{in}(\alpha) = (\beta_1, \dots, \beta_{\#\text{in}(\rho)})}}^{K_{\#\text{in}(\rho)}} W_{\#\text{in}(\beta_1), \dots, \#\text{in}(\beta_{\#\text{in}(\rho)})}^{\text{tree}} \hookrightarrow W_n^{\text{tree}}$$

by sending $((2T_\alpha)_\alpha, (T_\rho, (\widetilde{2T}_\alpha)_\alpha)_\rho)$ to the element of W_n^{tree} defined as follows. For $\alpha \in V_{\text{comp}}^1(T_b)$ with $\text{in}(\alpha) =: (\beta)$, replace the portion of T_b bounded by α and $\text{in}(\beta)$ by $2T_\alpha$; for $\rho \in V_{\text{int}}(T_s)$, replace the portion of T_s bounded by ρ and $\text{in}(\rho)$ by T_ρ ; and for $\rho \in V_{\text{int}}(T_s)$ and $\alpha \in V_{\text{comp}}^{\geq 2}(T_b) \cap f^{-1}\{\rho\}$ with $\text{in}(\alpha) =: (\beta_1, \dots, \beta_{\#\text{in}(\rho)})$, replace the portion of T_b bounded by α and $\text{in}(\beta_1), \dots, \text{in}(\beta_{\#\text{in}(\rho)})$ by $\widetilde{2T}_\alpha$. Then Γ_{2T} restricts to a poset isomorphism from its domain to $\text{cl}(2T) \subset W_n^{\text{tree}}$.

Proof We proceed in two steps.

Step 1 Γ_{2T} is a map of posets.

It suffices to show that for any

$$((2T_\alpha^{(2)})_\alpha, (T_\rho^{(2)}, (\widetilde{2T}_\alpha^{(2)})_\alpha)_\rho) < ((2T_\alpha^{(1)})_\alpha, (T_\rho^{(1)}, (\widetilde{2T}_\alpha^{(1)})_\alpha)_\rho),$$

there exists $((2T_\alpha^{(3)})_\alpha, (T_\rho^{(3)}, (\widetilde{2T}_\alpha^{(3)})_\alpha)_\rho)$ with

$$(39) \quad ((2T_\alpha^{(2)})_\alpha, (T_\rho^{(2)}, (\widetilde{2T}_\alpha^{(2)})_\alpha)_\rho) \leq ((2T_\alpha^{(3)})_\alpha, (T_\rho^{(3)}, (\widetilde{2T}_\alpha^{(3)})_\alpha)_\rho) < ((2T_\alpha^{(1)})_\alpha, (T_\rho^{(1)}, (\widetilde{2T}_\alpha^{(1)})_\alpha)_\rho),$$

$$(40) \quad \Gamma_{2T}((2T_\alpha^{(3)})_\alpha, (T_\rho^{(3)}, (\widetilde{2T}_\alpha^{(3)})_\alpha)_\rho) < \Gamma_{2T}((2T_\alpha^{(1)})_\alpha, (T_\rho^{(1)}, (\widetilde{2T}_\alpha^{(1)})_\alpha)_\rho).$$

To do so, first suppose that there exists $\alpha_0 \in V_{\text{comp}}^1(T_b)$ with $2T_{\alpha_0}^{(2)} < 2T_{\alpha_0}^{(1)}$. Define

$$((2T_\alpha^{(3)})_\alpha, (T_\rho^{(3)}, (\widetilde{2T}_\alpha^{(3)})_\alpha)_\rho)$$

to be the result of starting with $((2T_\alpha^{(1)})_\alpha, (T_\rho^{(1)}, (\widetilde{2T}_\alpha^{(1)})_\alpha)_\rho)$ and replacing $2T_{\alpha_0}^{(1)}$ by $2T_{\alpha_0}^{(2)}$. The assumption on α_0 implies that $2T_{\alpha_0}^{(2)}$ can be obtained from $2T_{\alpha_0}^{(1)}$ by performing a sequence of type-1 moves. Therefore $\Gamma_{2T}((2T_\alpha^{(3)})_\alpha, (T_\rho^{(3)}, (\widetilde{2T}_\alpha^{(3)})_\alpha)_\rho)$ can be obtained from $\Gamma_{2T}((2T_\alpha^{(1)})_\alpha, (T_\rho^{(1)}, (\widetilde{2T}_\alpha^{(1)})_\alpha)_\rho)$ by performing a sequence of type-1 moves.

If there exists no such α_0 , then we can choose $\rho_0 \in V_{\text{int}}(T_s)$ with $(T_{\rho_0}^{(2)}, (\widetilde{2T}_\alpha^{(2)})_\alpha) < (T_{\rho_0}^{(1)}, (\widetilde{2T}_\alpha^{(1)})_\alpha)$ and make an argument similar to the previous paragraph.

Step 2 Γ_{2T} restricts to a poset isomorphism onto $\text{cl}(2T)$.

The injectivity of Γ_{2T} is clear. It remains to show that the image of Γ_{2T} is equal to $\text{cl}(2T)$, and that the inverse is a poset map. By Step 1, the image of Γ_{2T} is contained in $\text{cl}(2T)$. Now define a putative inverse

$$(41) \quad \Gamma_{2T}^{-1}: \text{cl}(2T) \rightarrow \prod_{\substack{\alpha \in V_{\text{comp}}^1(T_b) \\ \text{in}(\alpha) = (\beta)}} W_{\# \text{in}(\beta)}^{\text{tree}} \times \prod_{\rho \in V_{\text{int}}(T_s)} \prod_{\substack{\alpha \in V_{\text{comp}}^{\geq 2}(T_b) \cap f^{-1}\{\rho\} \\ \text{in}(\alpha) = (\beta_1, \dots, \beta_{\# \text{in}(\rho)})}}^{K_{\# \text{in}(\rho)}} W_{\# \text{in}(\beta_1), \dots, \# \text{in}(\beta_{\# \text{in}(\rho)})}^{\text{tree}},$$

$$2T' \mapsto ((2T'_\alpha)_\alpha, (T'_\rho, (\widetilde{2T}'_\alpha)_\rho)),$$

like so:

- (a) For $\alpha \in V_{\text{comp}}^1(T_b)$ with $\text{in}(\alpha) =: (\beta)$, set $2T'_\alpha := (2T')^\alpha \in W_{\# \text{in}(\beta)}^{\text{tree}}$, where the latter stable tree-pair was defined in [Definition–Lemma 4.3\(a\)](#).
- (b) For $\rho \in V_{\text{int}}(T_s)$ and $\alpha \in V_{\text{comp}}^{\geq 2}(T_b)$ with $f(\alpha) = \rho$ and $\text{in}(\alpha) =: (\beta_1, \dots, \beta_{\# \text{in}(\rho)})$, define

$$(42) \quad (T'_\rho, (\widetilde{2T}'_\alpha)_\rho) := ((T'_s)^\rho, ((2T')^\alpha)_\rho),$$

where the latter expression was defined in [Definition–Lemma 4.3\(b\)](#).

It is simple to verify that Γ_{2T}^{-1} is an inverse for the restriction of Γ_{2T} to a map to $\text{cl}(2T)$, and to verify that Γ_{2T}^{-1} is a poset map. □

Now that we have recursively characterized the closed faces of W_n , we turn to our proof that \widehat{W}_n is an abstract polytope.

Theorem 4.5 For any $r \geq 1$ and $\mathbf{n} \in \mathbb{Z}_{\geq 0}^r \setminus \{\mathbf{0}, (1)\}$, the poset \widehat{W}_n is an abstract polytope of dimension $|\mathbf{n}| + r - 3$.

Proof We defer the proofs of DIAMOND and STRONGLY CONNECTED to Propositions 4.6 and 4.7, respectively, so here we only need to establish EXTREMAL, FLAG-LENGTH and the dimension formula.

The least face of \widehat{W}_n is the face F_{-1} we have added to W_n to form \widehat{W}_n , while the greatest face (in $\widehat{W}_n^{\text{br}}$) is the 2–bracketing $(\mathcal{B}, 2\mathcal{B})$ with

$$(43) \quad \mathcal{B} := \{\{1, \dots, r\}, \{1\}, \dots, \{r\}\},$$

$$2\mathcal{B} := \left\{ \left(\{1, \dots, r\}, (\{1, \dots, n_1\}, \dots, \{1, \dots, n_r\}) \right) \right\} \\ \cup \left\{ (\{i\}, (\{j\})) \mid 1 \leq i \leq r, 1 \leq j \leq n_i \right\}.$$

This establishes EXTREMAL.

To prove FLAG-LENGTH and to show that the dimension of W_n is $|n| + r - 3$, we must show that if $2T^0 < \dots < 2T^\ell$ is a maximal chain in W_n^{tree} , then $\ell = |n| + r - 3$. By Lemmas 3.5 and 3.7, we have $0 \leq d(2T^0) < \dots < d(2T^\ell) \leq |n| + r - 3$. To prove the claim, we must show that every dimension between 0 and $|n| + r - 3$ is represented. For any T^i, T^{i+1} , we must have $d(T^i) = d(T^{i+1}) - 1$: otherwise, there exists $T' \in W_n^{\text{tree}}$ which can be obtained by performing a single move to T^{i+1} , and which satisfies $d(T^i) < d(T') < d(T^{i+1})$; this would contradict the maximality of the chain. Again by maximality, we must have $2T^\ell = F_{\text{top}}$. It remains to show $d(T^0) = 0$. Suppose for the sake of contradiction that $d(T^0)$ is positive. Then by Lemma 3.5, either (a) there exists $\alpha \in V_{\text{comp}}^1(T_b)$ with $\# \text{in}(\beta) \geq 3$ for $(\beta) := \text{in}(\alpha)$; (b) there exists $\alpha \in V_{\text{comp}}^{\geq 2}(T_b)$ with $\sum_{\beta \in \text{in}(\alpha)} \# \text{in}(\beta) \geq 2$; or (c) there exists $\alpha \in (T_s)_{\text{int}}$ with $\# \text{in}(\alpha) \geq 3$. In these three cases we may perform a move to $2T^0$ of type 1, type 3 or type 2, respectively, which contradicts the maximality of our chain. \square

Proposition 4.6 For any $r \geq 1$ and $n \in \mathbb{Z}_{\geq 0}^r \setminus \{\mathbf{0}\}$, the poset \widehat{W}_n satisfies DIAMOND.

Proof We must show that for every $F < G$ in \widehat{W}_n with $d(G) - d(F) = 2$, the open interval (F, G) contains exactly 2 elements. In the following steps, we prove this in the cases $F \neq F_{-1}$ and $F = F_{-1}$.

Step 1 For $F < G$ in W_n with $d(G) - d(F) = 2$, the open interval (F, G) contains exactly 2 elements.

In this step, we work with W_n^{tree} . Fix $2T, 2T' \in W_n^{\text{tree}}$ with $d(2T) - d(2T') = 2$. Then $2T'$ can be obtained from $2T$ by applying two moves; we must prove that there are exactly two elements of the open interval $(2T', 2T)$. There are nine cases to consider, depending on whether each of the two moves are of type 1, 2 or 3. This proof quickly becomes repetitive, so we only give details in the case of two type-3 moves.

Suppose that $2T'$ is indeed the result of applying two type-3 moves to $2T$. Denote the modifications to T_b as in the upper-left and upper-right arrows of Figure 15, where an arrow indicates a single move, and the adjacent number indicates the type of move. (Here we have chosen a partition of \mathbf{a} as $\mathbf{a} = \sum_{i=1}^q \mathbf{b}^i$, then chosen a partition of \mathbf{b}^p as $\mathbf{b}^p = \sum_{j=1}^r \mathbf{c}^j$.) Then there is exactly one other element of the open interval $(2T', 2T)$: the one obtained from $2T$ by replacing the portion of T_b on the left of the figure by the bottom configuration in the figure. Note that this alternative path from $2T$ to $2T'$ consists not of two type-3 moves, but by a type-3 move followed by a type-1 move.

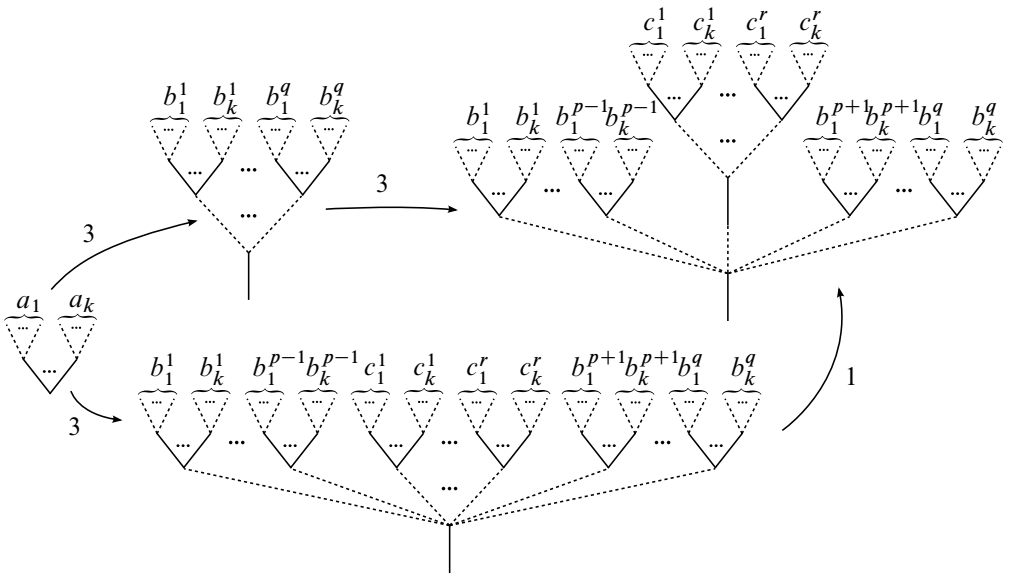

Figure 15

The other subcases to consider are simpler than this one. Moreover, the other eight cases are similar to this one; rather than include the details, we show in Table 1 representative examples of the diamond property.

Step 2 For $G \in W_n$ with $d(G) = 1$, the open interval (F_{-1}, G) contains exactly 2 elements.

In this step, we again work with W_n^{tree} . Fix $2T \in W_n^{\text{tree}}$ with $d(2T) = 1$. It follows from Lemma 3.5 that the vertices in $2T$ satisfy exactly one of three valency conditions, which we treat in cases below:

- Every $\rho \in (T_s)_{\text{int}}$ has $\# \text{in}(\rho) = 2$. There is a single $\alpha \in V_{\text{comp}}^1(T_b)$ with $\# \text{in}(\beta) = 3$, where β is the incoming neighbor of α ; every $\gamma \in V_{\text{comp}}^1(T_b) \setminus \{\alpha\}$ with $\text{in}(\gamma) =: (\delta)$ has $\# \text{in}(\delta) = 2$; and every $\gamma \in V_{\text{comp}}^{\geq 2}(T_b)$ with $\text{in}(\gamma) =: (\delta_1, \delta_2)$ has $\# \text{in}(\delta_1) + \# \text{in}(\delta_2) = 1$.

In this case, the only moves that can be performed on $2T$ are type-1 moves based at α . If we denote $\text{in}(\beta) =: (\gamma_1, \gamma_2, \gamma_3)$, then the type-1 moves at α correspond to proper consecutive subsets of $(\gamma_1, \gamma_2, \gamma_3)$ of length at least 2; (γ_1, γ_2) and (γ_2, γ_3) are the only such subsets.

- Every $\rho \in (T_s)_{\text{int}}$ has $\# \text{in}(\rho) = 2$. There is a single $\alpha \in V_{\text{comp}}^{\geq 2}(T_b)$ with $\# \text{in}(\beta_1) + \# \text{in}(\beta_2) = 2$, where β_1, β_2 are the incoming neighbors of α ; every $\gamma \in V_{\text{comp}}^1(T_b)$ with $\text{in}(\gamma) =: (\delta)$ has $\# \text{in}(\delta) = 2$; and every $\gamma \in V_{\text{comp}}^{\geq 2}(T_b) \setminus \{\alpha\}$ with $\text{in}(\gamma) =: (\delta_1, \delta_2)$ has $\# \text{in}(\delta_1) + \# \text{in}(\delta_2) = 1$.

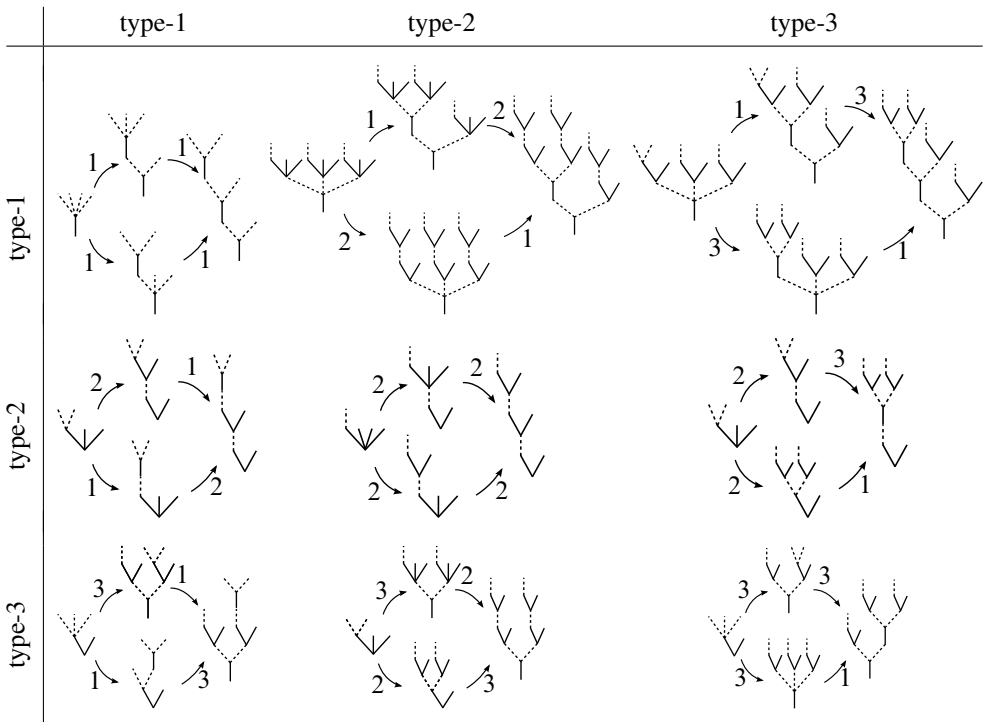

Table 1: In this step we show that for any $2T, 2T' \in W_n^{\text{tree}}$ with $d(2T) - d(2T') = 2$, the open interval $(2T', 2T)$ contains two elements. Here we illustrate this fact in nine cases: $2T'$ can be obtained from $2T$ by applying two moves, and these moves can be of type 1, 2, or 3. In each case, the four configurations are the bubble trees T_b of a stable tree-pair; the seam trees can be inferred from the bubble tree. On the left is $2T$, on the right is $2T'$, and the remaining two stable tree-pairs are the two elements of $(2T', 2T)$. The arrows indicate moves, and their labels are the types.

There are two subcases: either

- (a) $(\# \text{in}(\beta_1), \# \text{in}(\beta_2)) = (1, 1)$, or
- (b) $(\# \text{in}(\beta_1), \# \text{in}(\beta_2)) \in \{(2, 0), (0, 2)\}$.

If (a) holds, the only moves that can be performed on $2T$ are type-3 moves based at α . In the notation of the definition of type-3 moves, $\mathbf{a} = (1, 1)$, and the type-3 moves at α correspond to choices of $\mathbf{b}^1, \dots, \mathbf{b}^q \in \mathbb{Z}_{\geq 0}^2 \setminus \{\mathbf{0}\}$ with $\sum_j \mathbf{b}^j = \mathbf{a}$. There are two such choices: $\mathbf{b}^1 = (1, 0)$ and $\mathbf{b}^2 = (0, 1)$, or $\mathbf{b}^1 = (0, 1)$ and $\mathbf{b}^2 = (1, 0)$. On the other hand, if (b) holds, we can either perform a type-1 move or a type-3 move at α , and there is only one possible move of each type.

- A single $\rho \in (T_s)_{\text{int}}$ has $\# \text{in}(\rho) = 3$. Every $\alpha \in V_{\text{comp}}^1(T_b)$ with $\text{in}(\alpha) =: (\beta)$ has $\# \text{in}(\beta) = 2$; every $\alpha \in V_{\text{comp}}^{\geq 2}(T_b)$ with $\text{in}(\alpha) =: (\beta_1, \beta_2)$ has $\# \text{in}(\beta_1) + \# \text{in}(\beta_2) = 1$; and every $\sigma \in (T_s)_{\text{int}} \setminus \{\rho\}$ has $\# \text{in}(\sigma) = 2$.

In this case, the only moves that can be performed on $2T$ are type-2 moves based at ρ . Write $\text{in}(\rho) =: (\sigma_1, \sigma_2, \sigma_3)$. The type-2 moves based at ρ correspond to (1) a choice of a proper consecutive subset of $\text{in}(\rho)$ of length at least 2 (of which there are two), and (2) for every $\alpha \in V_{\text{comp}}^{\geq 2}(T_b)$ with $f(\alpha) = \rho$, a choice of $q \geq 0$ and $\mathbf{b}^1, \dots, \mathbf{b}^q \in \mathbb{Z}_{\geq 0}^\ell \setminus \{\mathbf{0}\}$ with $\sum_j \mathbf{b}^j = \mathbf{a}$, where $\mathbf{a} \in \mathbb{Z}_{\geq 0}^\ell \setminus \{\mathbf{0}\}$ is defined by setting $\text{in}(\alpha) =: (\beta_1, \beta_2, \beta_3)$ and $a_i := \# \text{in}(\beta_{p+i})$. By assumption, $|\mathbf{a}| = 1$ for every such α . Therefore there is exactly one choice of the decomposition $\mathbf{a} = \sum_j \mathbf{b}^j$, so there are two type-2 moves based at ρ . □

Proposition 4.7 For any $r \geq 1$ and $\mathbf{n} \in \mathbb{Z}_{\geq 0}^r \setminus \{\mathbf{0}\}$, the poset $\widehat{W}_{\mathbf{n}}$ is strongly connected.

Proof We must show that for every $F < G$ in $\widehat{W}_{\mathbf{n}}$ with $d(G) - d(F) \geq 3$, the closed interval $[F, G]$ is connected, ie any two elements in the open interval (F, G) can be connected by a path contained in (F, G) . In the following steps, we prove this in the cases $F \neq F_{-1}$ and $F = F_{-1}$.

Step 1 For $s \geq 1$ and $\mathbf{m}^1, \dots, \mathbf{m}^\ell \in \mathbb{Z}_{\geq 0}^s \setminus \{\mathbf{0}\}$, consider the completed fiber product $P := \{F_{-1}\} \cup \prod_{1 \leq i \leq \ell}^{K_s^{\text{tree}}} W_{\mathbf{m}^i}^{\text{tree}}$. Define a dimension function on P by

$$(44) \quad d(T, (2T^{(i)})_i) := d(T) + \sum_{1 \leq i \leq \ell} (d(2T^{(i)}) - d(T)), \quad d(F_{-1}) := -1.$$

Denote the maximal element of P by F_{top} . For any $G \in P$ with $d(F_{\text{top}}) - d(G) \geq 3$, the interval $[G, F_{\text{top}}]$ is connected.

We divide this step into two cases, depending on whether or not G is the minimal element F_{-1} .

First, suppose $G = F_{-1}$. The condition $d(F_{\text{top}}) - d(G) \geq 3$ translates into the condition $s - 2 + \sum_{1 \leq i \leq \ell} (|\mathbf{m}^i| - 1) \geq 2$, which implies that at least one of these conditions holds:

- (a) $s \geq 4$.
- (b) $s \geq 3$ and there exists i with $|\mathbf{m}^i| \geq 2$.
- (c) There exist $i \neq j$ with $|\mathbf{m}^i| \geq 2$ and $|\mathbf{m}^j| \geq 2$.
- (d) There exists i with $|\mathbf{m}^i| \geq 3$.

In case (a), it suffices to show that for any face H in (F_{-1}, F_{top}) with $d(H) = d(F^{\text{top}}) - 1$, there is a path in (F_{-1}, F_{top}) from H to the following element of P :

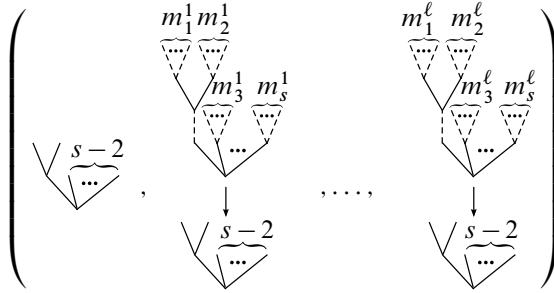

This can be shown by an argument similar to the one made in Proposition 2.18 to prove the STRONGLY CONNECTED property for the associahedra. The same is true for cases (b)–(d).

Second, we must show that $[G, F_{\text{top}}]$ is connected for $G \neq F_{-1}$. We do so by using the 2-bracketing model for 2-associahedra. Write $G = (\widehat{\mathcal{B}}, (\widehat{2\mathcal{B}}_i)_{i=1}^{\ell})$. Throughout this proof we often abbreviate 2-bracketings by their collection of 2-bracketings and omit the underlying 1-bracketing, as this 1-bracketing will be evident. Fix distinct $F^{(j)} := (\mathcal{B}^{(j)}, (2\mathcal{B}_i^{(j)})_{i=1}^{\ell}) \in (G, F_{\text{top}}) \subset P$ for $j \in \{1, 2\}$; we must show that there is a path between these elements within (G, F_{top}) . Without loss of generality, we may assume $d(F^{(j)}) = d(F_{\text{top}}) - 1$ for $j \in \{1, 2\}$. It follows that each $F^{(j)}$ can be obtained in exactly one of the following ways, where we write $F_{\text{top}} := (\mathcal{B}, (2\mathcal{B}_i)_i)$:

- (1) Perform a type-1 move on a single $2\mathcal{B}_i$.
- (2) Perform a single move $\mathcal{B} \rightarrow \mathcal{B}'$, then perform a type-2 move $2\mathcal{B}_i \rightarrow 2\mathcal{B}'_i$ for every $1 \leq i \leq \ell$, such that $\pi(2\mathcal{B}'_i) = \mathcal{B}'$.
- (3) Perform a type-3 move on a single $2\mathcal{B}_i$.

Define $\tilde{F} := (\mathcal{B}^{(1)} \cup \mathcal{B}^{(2)}, (2\mathcal{B}_i^{(1)} \cup 2\mathcal{B}_i^{(2)})_i)$. Then \tilde{F} is again an element of the fiber product P , where for $B_0 \in \mathcal{B}^{(1)} \cup \mathcal{B}^{(2)}$ and $1 \leq i \leq \ell$ the partial order on $(2\mathcal{B}_i^{(1)} \cup 2\mathcal{B}_i^{(2)})_{B_0}$ is induced by the partial order on the larger collection $(\widehat{2\mathcal{B}}_i)_{B_0}$. If (1) holds for $F^{(j)}$ for both $j = 1$ and $j = 2$, then $d(\tilde{F}) = d(F_{\text{top}}) - 2$; we can then connect $F^{(1)}$ and $F^{(2)}$ by the path $F^{(1)} \rightarrow \tilde{F} \rightarrow F^{(2)}$. The same is true in all of the other cases, except in the cases that (2) holds for $j \in \{1, 2\}$, or that (3) holds for $j \in \{1, 2\}$: here, $d(\tilde{F})$ could be less than $d(F_{\text{top}})$. The constructions in these two situations are similar, so we assume that (3) holds for $j \in \{1, 2\}$. Let i_j , $j = 1, 2$, denote the indices with the property that $F^{(j)}$ is obtained from F_{top} by performing

a type-3 move on $2\mathcal{B}_{i_j}$. If $i_1 \neq i_2$, then $d(\tilde{F}) = d(F_{\text{top}}) - 2$ and we can again use the path $F^{(1)} \rightarrow \tilde{F} \rightarrow F^{(2)}$. Suppose, on the other hand, that $i_1 = i_2 =: i_0$. If $d(\widehat{2\mathcal{B}}_{i_0}) = d(2\mathcal{B}_{i_0}) - 2$, we can again use the construction described above. Otherwise, it suffices to show that there is a path from $2\mathcal{B}_{i_0}^{(1)}$ to $2\mathcal{B}_{i_0}^{(2)}$ within $(\widehat{2\mathcal{B}}_{i_0}, F_{\text{top}}^{Wm^{i_0}})$. Towards this, we express $2\mathcal{B}_{i_0}^{(1)}$ and $2\mathcal{B}_{i_0}^{(2)}$ as

$$(45) \quad \begin{aligned} 2\mathcal{B}_{i_0}^{(j)} = & \{(\{1, \dots, s\}, (\{1, \dots, m_1^{i_0}\}, \dots, \{1, \dots, m_s^{i_0}\}))\} \\ & \cup \{(\{k\}, (\{\ell\})) \mid 1 \leq k \leq s, 1 \leq \ell \leq m_k^{i_0}\} \\ & \cup \{(\{1, \dots, s\}, (A_{t,1}^{(j)}, \dots, A_{t,s}^{(j)})) \mid 1 \leq t \leq q^{(j)}\} \\ =: & 2\mathcal{B}_{\text{top}} \cup \{(\{1, \dots, s\}, (A_{t,1}^{(j)}, \dots, A_{t,s}^{(j)})) \mid 1 \leq t \leq q^{(j)}\}. \end{aligned}$$

To define our path from $2\mathcal{B}_{i_0}^{(1)}$ to $2\mathcal{B}_{i_0}^{(2)}$, we begin by examining $(A_{1,1}^{(1)}, \dots, A_{1,s}^{(1)})$ and $(A_{1,1}^{(2)}, \dots, A_{1,s}^{(2)})$. If these sequences of sets are equal, we do nothing. If they are not equal, then because $2\mathcal{B}_{i_0}^{(1)}, 2\mathcal{B}_{i_0}^{(2)}$ are bounded from below by $\widehat{2\mathcal{B}}_{i_0}$, there must exist $q' \geq 2$ such that one of the following equalities holds:

$$(46) \quad \begin{aligned} (A_{1,1}^{(1)}, \dots, A_{1,s}^{(1)}) &= (A_{1,1}^{(2)} \cup \dots \cup A_{q',1}^{(2)}, \dots, A_{1,s}^{(2)} \cup \dots \cup A_{q',s}^{(2)}), \\ (A_{1,1}^{(2)}, \dots, A_{1,s}^{(2)}) &= (A_{1,1}^{(1)} \cup \dots \cup A_{q',1}^{(1)}, \dots, A_{1,s}^{(1)} \cup \dots \cup A_{q',s}^{(1)}). \end{aligned}$$

Suppose that the first equality holds. Then we define the first two steps in our path by

$$(47) \quad \begin{aligned} (2\mathcal{B}_{i_0}^{(1)} = & 2\mathcal{B}_{\text{top}} \cup \{(\{1, \dots, s\}, (A_{t,1}^{(1)}, \dots, A_{t,s}^{(1)})) \mid 1 \leq t \leq q^{(1)}\}, \\ & 2\mathcal{B}_{\text{top}} \cup \{(\{1, \dots, s\}, (A_{t,1}^{(1)}, \dots, A_{t,s}^{(1)})) \mid 1 \leq t \leq q^{(1)}\} \\ & \cup \{(\{1, \dots, s\}, (A_{t,1}^{(2)}, \dots, A_{t,s}^{(2)})) \mid 1 \leq t \leq q'\}, \\ & 2\mathcal{B}_{\text{top}} \cup \{(\{1, \dots, s\}, (A_{t,1}^{(1)}, \dots, A_{t,s}^{(1)})) \mid 2 \leq t \leq q^{(1)}\} \\ & \cup \{(\{1, \dots, s\}, (A_{t,1}^{(2)}, \dots, A_{t,s}^{(2)})) \mid 1 \leq t \leq q'\}). \end{aligned}$$

If, on the other hand, the second equation in (46) holds, we define the first two steps in our path like so:

$$(48) \quad \begin{aligned} (2\mathcal{B}_{i_0}^{(1)} = & 2\mathcal{B}_{\text{top}} \cup \{(\{1, \dots, s\}, (A_{t,1}^{(1)}, \dots, A_{t,s}^{(1)})) \mid 1 \leq t \leq q^{(1)}\}, \\ & 2\mathcal{B}_{\text{top}} \cup \{(\{1, \dots, s\}, (A_{t,1}^{(1)}, \dots, A_{t,s}^{(1)})) \mid 1 \leq t \leq q^{(1)}\} \\ & \cup \{(\{1, \dots, s\}, (A_{1,1}^{(2)}, \dots, A_{1,s}^{(2)}))\}, \\ & 2\mathcal{B}_{\text{top}} \cup \{(\{1, \dots, s\}, (A_{t,1}^{(1)}, \dots, A_{t,s}^{(1)})) \mid q' + 1 \leq t \leq q^{(1)}\} \\ & \cup \{(\{1, \dots, s\}, (A_{1,1}^{(2)}, \dots, A_{1,s}^{(2)}))\}). \end{aligned}$$

By proceeding in this fashion, we can construct a path from $2\mathcal{B}^{(1)}$ to $2\mathcal{B}^{(2)}$ whose elements are either of codimension 1 or 2 in W_{m^i0} and which are bounded below by G .

Step 2 For $G \in W_n$ with $d(G) \geq 2$, the closed interval $[F_{-1}, G]$ is connected.

Fix $2T \in W_n^{\text{tree}}$ with $d(2T) \geq 2$. By [Definition–Lemma 4.4](#), we have the formula

$$(49) \quad [F_{-1}, 2T] \simeq \{F_{-1}\} \cup \prod_{\substack{\alpha \in V_{\text{comp}}^1(T_b) \\ \text{in}(\alpha) = (\beta)}} W_{\# \text{in}(\beta)}^{\text{tree}} \times \prod_{\rho \in V_{\text{int}}(T_s)} \prod_{\substack{\alpha \in V_{\text{comp}}^{\geq 2}(T_b) \cap f^{-1}\{\rho\} \\ \text{in}(\alpha) = (\beta_1, \dots, \beta_{\# \text{in}(\rho)})}} K_{\# \text{in}(\rho)}^{\text{tree}} W_{\# \text{in}(\beta_1), \dots, \# \text{in}(\beta_{\# \text{in}(\rho)})}^{\text{tree}}.$$

A calculation using [Lemma 3.5](#) yields the equality

$$(50) \quad d(G) = \sum_{\substack{\alpha \in V_{\text{comp}}^1(T_b) \\ \text{in}(\alpha) = (\beta)}} \dim(W_{\# \text{in}(\beta)}^{\text{tree}}) + \sum_{\rho \in V_{\text{int}}(T_s)} \dim\left(\prod_{\substack{\alpha \in V_{\text{comp}}^{\geq 2}(T_b) \cap f^{-1}\{\rho\} \\ \text{in}(\alpha) = (\beta_1, \dots, \beta_{\# \text{in}(\rho)})}} K_{\# \text{in}(\rho)}^{\text{tree}} W_{\# \text{in}(\beta_1), \dots, \# \text{in}(\beta_{\# \text{in}(\rho)})}^{\text{tree}}\right).$$

(We have not shown that the fiber products are abstract polytopes. The dimension of this fiber product should be interpreted as the dimension of the top face, using the dimension function d defined in (44).) The inequality $d(G) \geq 2$ implies that either (a) one of the posets in (50) has dimension at least 2 or (b) at least two of the posets in (50) have positive dimension. If (b) holds, $[F_{-1}, G]$ is clearly connected. Next, suppose (a) holds. If $\dim(W_{\# \text{in}(\beta)}^{\text{tree}}) \geq 2$ for some $\alpha \in V_{\text{comp}}^1(T_b)$ with $\text{in}(\alpha) = (\beta)$, then the connectedness of $[F_{-1}, G]$ follows from the isomorphism $W_{\# \text{in}(\beta)}^{\text{tree}} \simeq K_{\# \text{in}(\beta)}^{\text{tree}}$ proven in [Lemma 3.9](#) and the strong connectedness of the associahedra proven in [Proposition 2.18](#). If one of the fiber products in (50) has dimension at least 2, then the connectedness of $[F_{-1}, G]$ follows from Step 1.

Step 3 For $F < G$ in W_n with $d(G) - d(F) \geq 3$, the closed interval $[F, G]$ is connected.

The argument in Step 2 applies equally well to this case. □

Appendix 2– and 3–dimensional 2–associahedra

In this appendix, we work out all¹ the 2– and 3–dimensional 2–associahedra W_n . First, we record the face vectors of these examples and note whether or not \widehat{W}_n is

¹We make use of the identity $W_{n_1, n_2, \dots, n_r} \simeq W_{n_r, n_{r-1}, \dots, n_1}$. Also, we do not include 2–associahedra of the form W_{n_1} or $W_{0, \dots, 0, 1, 0, \dots, 0}$, since these can be identified with associahedra via [Lemma 3.9](#) and the following remark.

simple. (An abstract d -polytope is *simple* if every 0 -face is adjacent to exactly d 1 -faces. The author believes that for every $r \geq 2$ and $\mathbf{n} \in \mathbb{Z}_{\geq 0}^r$ with $|\mathbf{n}| \geq 4$, $\widehat{W}_{\mathbf{n}}$ is not simple.) Second, we give “net” representations of these examples, where each vertex corresponds to a 0 -face of $W_{\mathbf{n}}$, each edge to a 1 -face, and each polygonal face to a 2 -face. In the case of the 3 -dimensional examples, we do not represent the 3 -dimensional face. Each numbered edge should be identified with the correspondingly numbered edge. Some faces are labeled by the 2 -bracketings to which they correspond.

2-dimensional 2-associahedra			3-dimensional 2-associahedra		
\mathbf{n}	Face vector	Simple?	\mathbf{n}	Face vector	Simple?
30	(6,6,1)	yes	40	(21,32,13,1)	no
21	(8,8,1)	yes	31	(36,56,22,1)	no
200	(5,5,1)	yes	22	(44,69,27,1)	no
110	(6,6,1)	yes	300	(18,27,11,1)	yes
101	(4,4,1)	yes	210	(30,45,17,1)	yes
020	(6,6,1)	yes	201	(18,27,11,1)	yes
			120	(32,48,18,1)	yes
			030	(24,36,14,1)	yes
			2000	(14,21,9,1)	yes
			1100	(18,27,11,1)	yes
			1010	(14,21,9,1)	yes
			1001	(10,15,7,1)	yes
			0200	(18,27,11,1)	yes
			0110	(22,33,13,1)	yes

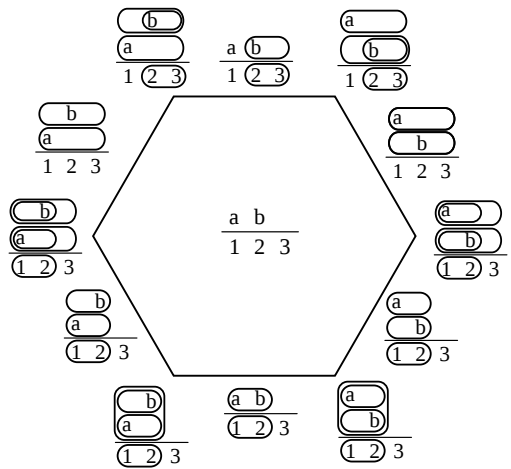
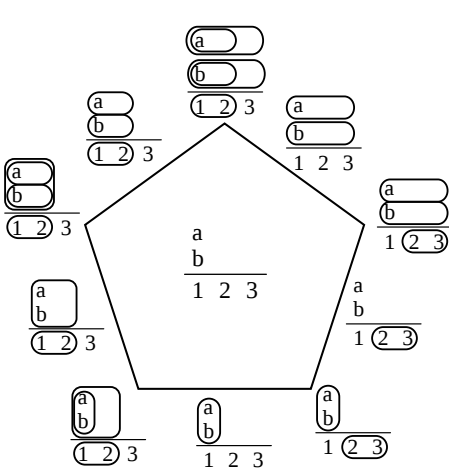

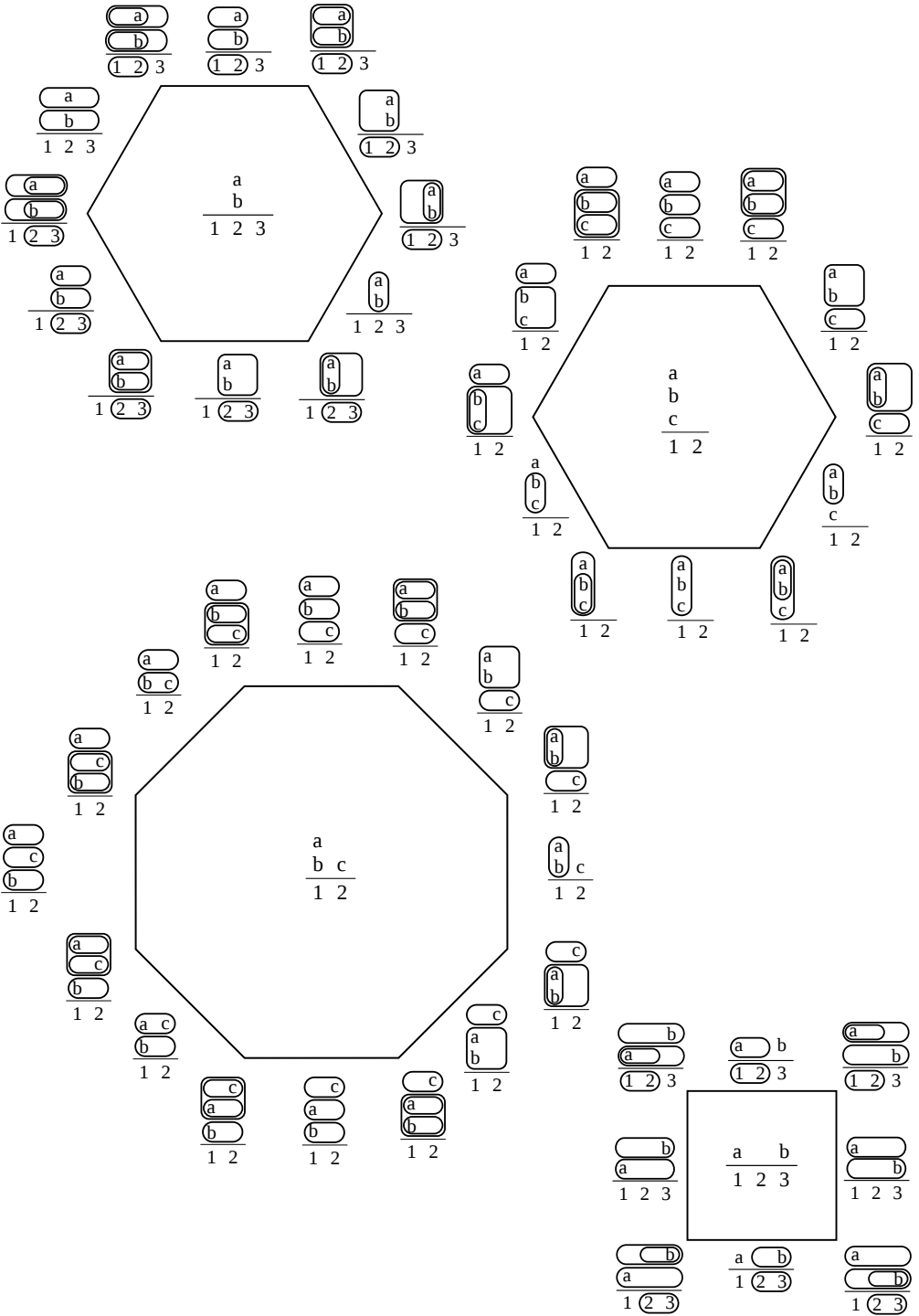

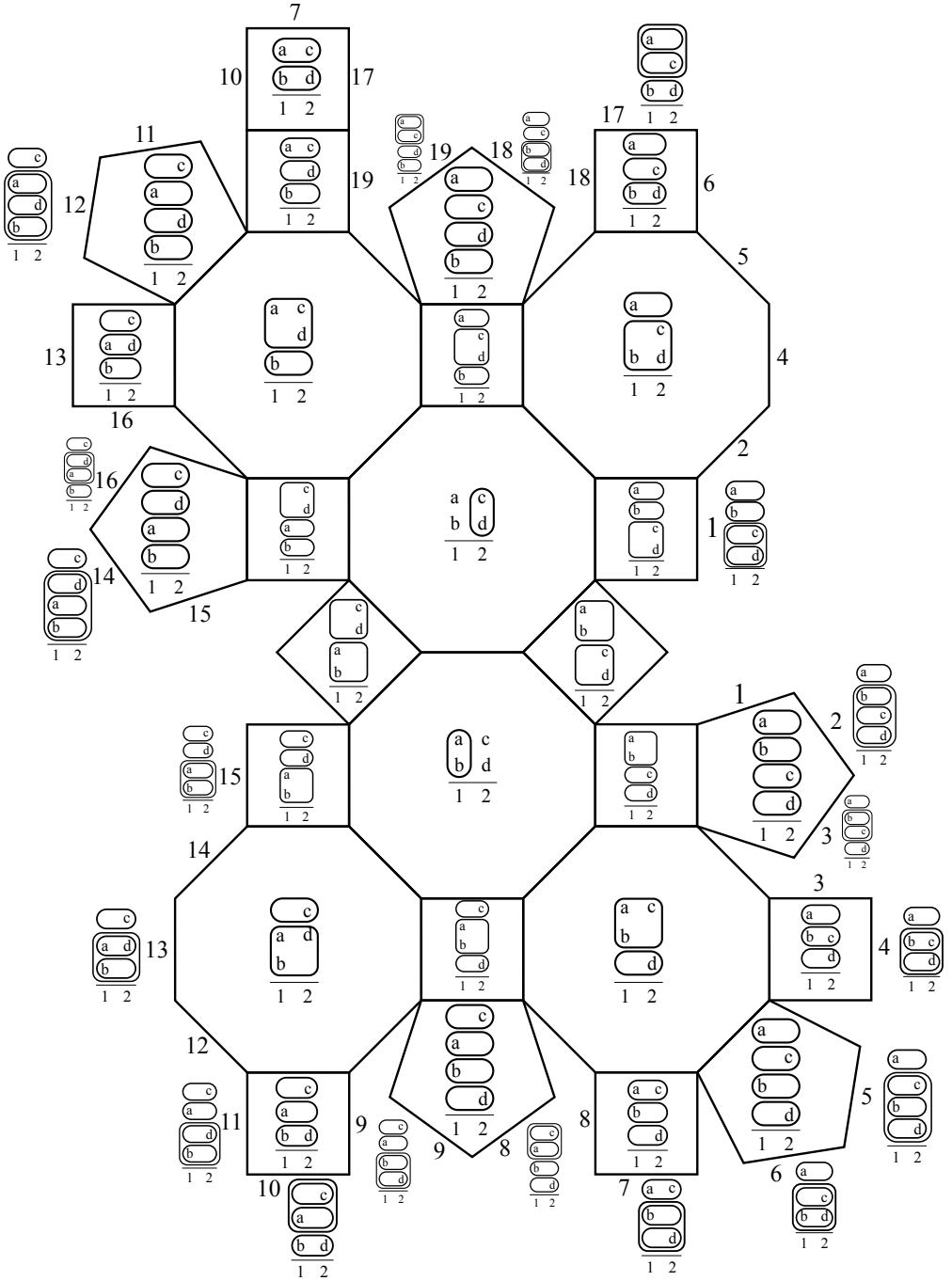

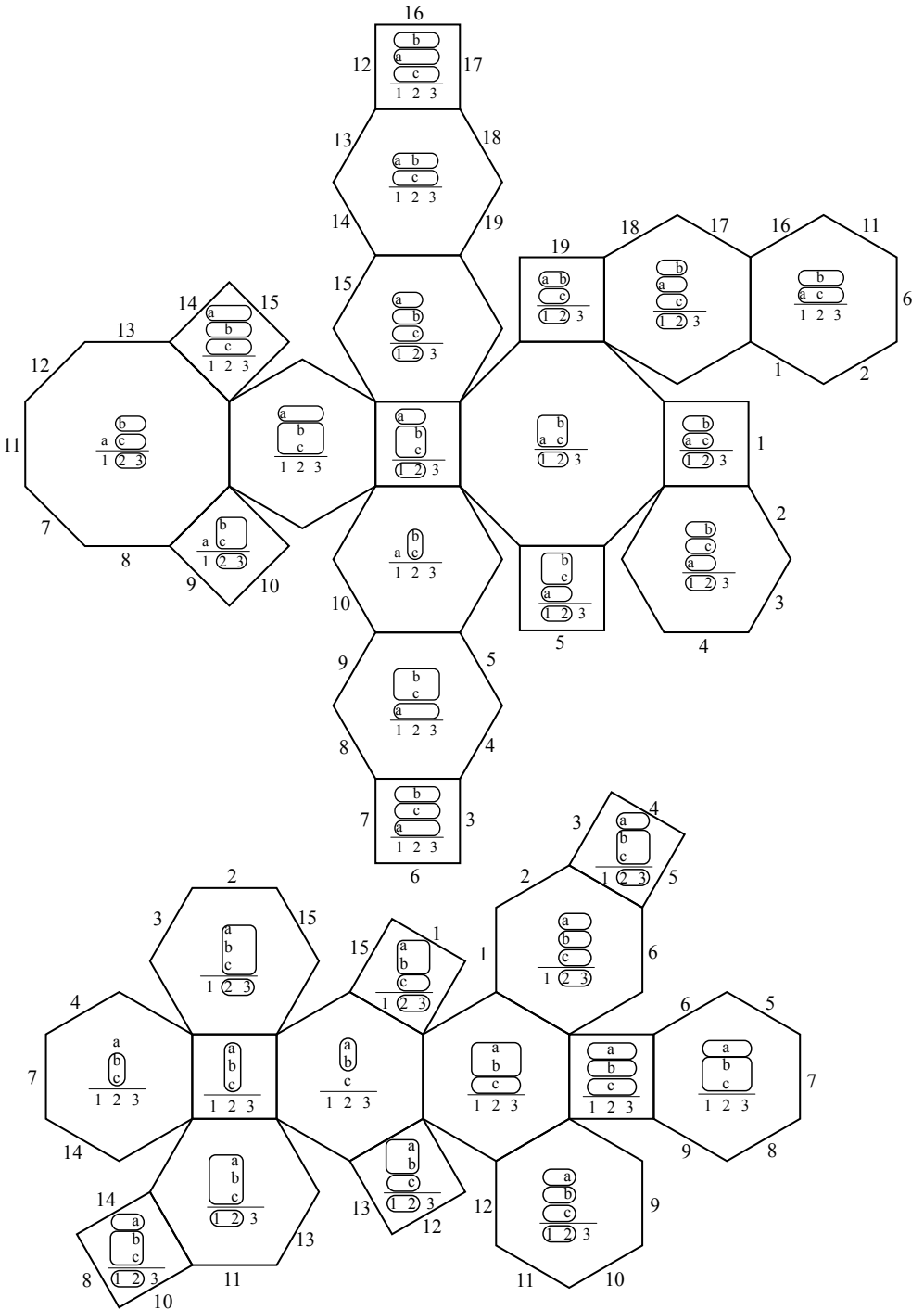

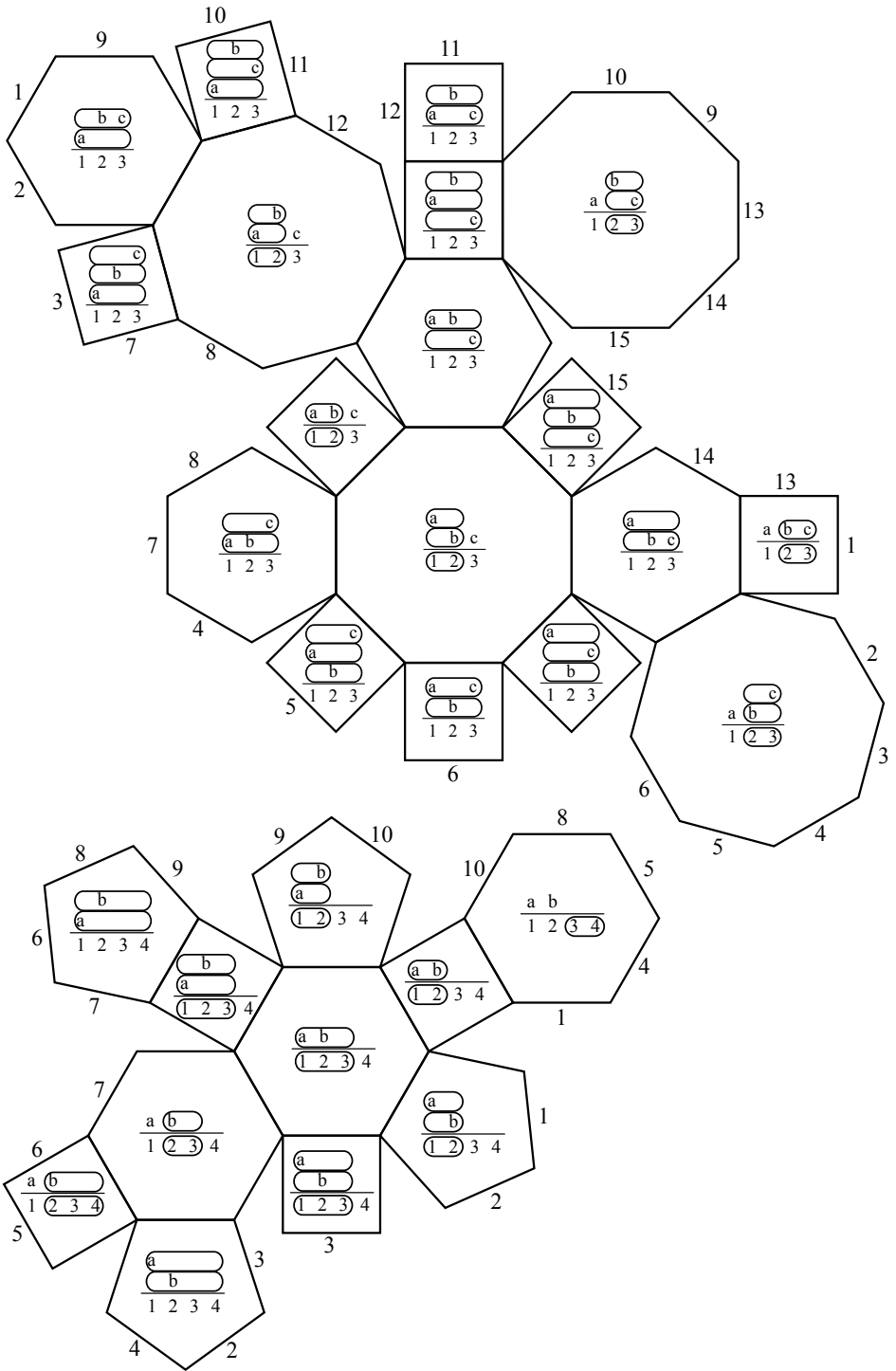

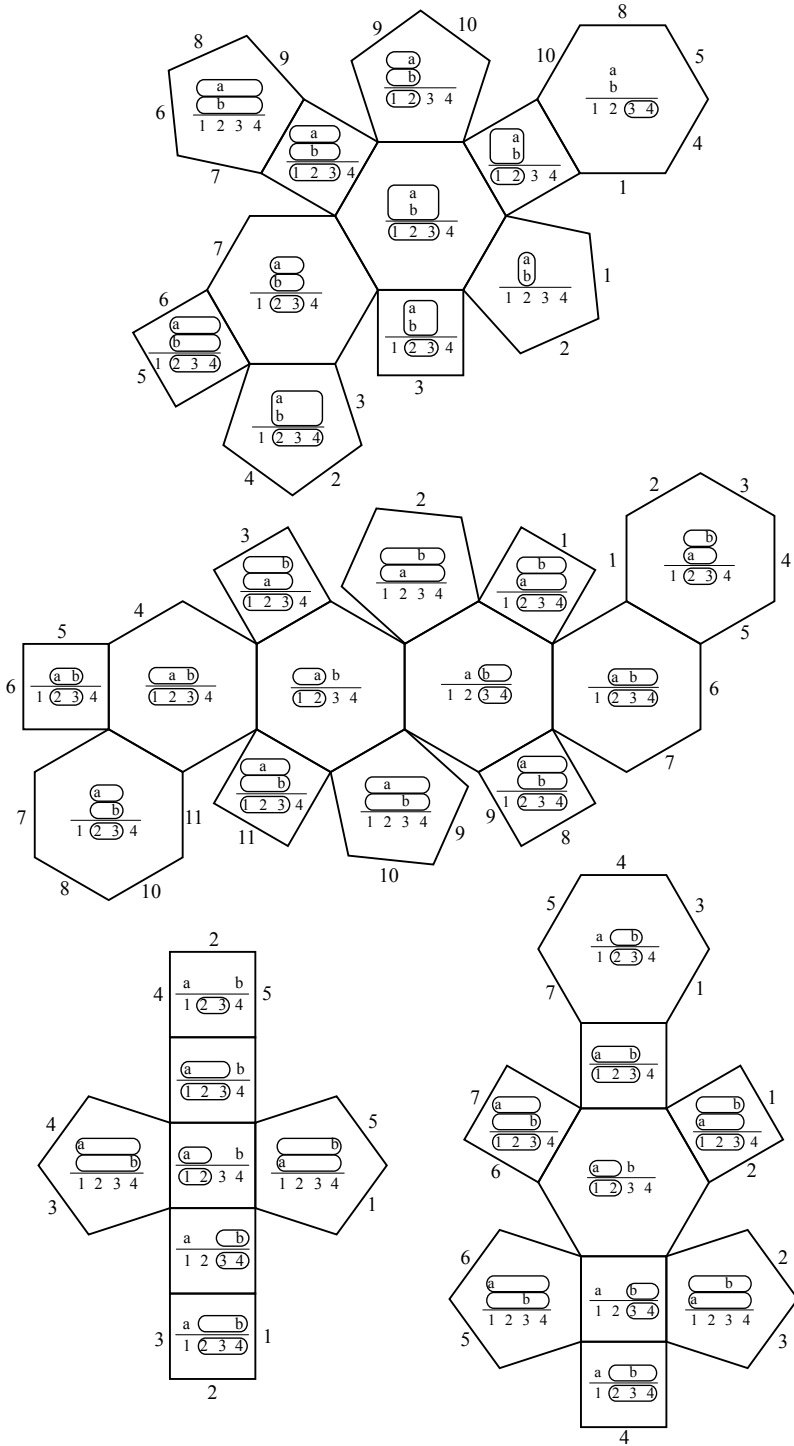

References

- [1] **N Bottman**, *Pseudoholomorphic quilts with figure eight singularity*, preprint (2014) [arXiv](#) To appear in J. Symplectic Geom.
- [2] **NS Bottman**, *Pseudoholomorphic quilts with figure eight singularity*, PhD thesis, Massachusetts Institute of Technology (2015) [MR](#) Available at <https://search.proquest.com/docview/1784002480>
- [3] **N Bottman**, *Moduli spaces of witch curves topologically realize the 2–associahedra*, preprint (2017) [arXiv](#) To appear in J. Symplectic Geom.
- [4] **N Bottman, K Wehrheim**, *Gromov compactness for squiggly strip shrinking in pseudoholomorphic quilts*, *Selecta Math.* 24 (2018) 3381–3443 [MR](#)
- [5] **S Ma’u, K Wehrheim, C Woodward**, *A_∞ functors for Lagrangian correspondences*, *Selecta Math.* 24 (2018) 1913–2002 [MR](#)
- [6] **D McDuff, D Salamon**, *J–holomorphic curves and symplectic topology*, 2nd edition, American Mathematical Society Colloquium Publications 52, Amer. Math. Soc., Providence, RI (2004) [MR](#)

*School of Mathematics, Institute for Advanced Study
Princeton, NJ, United States*

nbottman@math.ias.edu

Received: 3 September 2017 Revised: 19 June 2018