

Closed quasi-Fuchsian surfaces in hyperbolic knot complements

JOSEPH D MASTERS
XINGRU ZHANG

We show that every hyperbolic knot complement contains a closed quasi-Fuchsian surface.

[57N35](#); [57M25](#)

1 Introduction

By a *knot complement* we mean, in this paper, the complement of a knot in a connected closed orientable 3-manifold (which is not necessarily S^3). A knot complement is said to be *hyperbolic* if it admits a complete hyperbolic metric of finite volume. By a *surface* we mean, in this paper, the complement of a finite (possibly empty) set of points in the interior of a compact, connected, orientable 2-manifold. By a *surface in a 3-manifold* M , we mean a continuous, proper map $f: S \rightarrow M$ from a surface S into M . A surface $f: S \rightarrow M$ in a 3-manifold M is said to be *incompressible* if S is not a 2-sphere and the induced homomorphism $f^*: \pi_1(S, s) \rightarrow \pi_1(M, f(s))$ is injective for one (and thus for any) choice of base point s in S . A surface $f: S \rightarrow M$ in a 3-manifold M is said to be *essential* if it is incompressible and the map $f: S \rightarrow M$ cannot be homotoped into a boundary component or an end component of M .

Essential surfaces in hyperbolic knot complements can be divided into three mutually exclusive geometric types: quasi-Fuchsian surfaces, geometrically infinite surfaces and essential surfaces with accidental parabolics. Now we recall the relevant terminology. Let \mathbb{H}^3 denote the hyperbolic 3-space (always in the upper half space model) and let $S_\infty^2 = \mathbb{C} \cup \{\infty\}$ denote the boundary at infinity, where \mathbb{C} is the plane of complex numbers. Let $\overline{\mathbb{H}^3} = \mathbb{H}^3 \cup S_\infty^2$ be the compactification of \mathbb{H}^3 , which is topologically a compact 3-ball. The action of every element of the orientation preserving isometry group $\text{Isom}^+(\mathbb{H}^3)$ extends to an action on $\overline{\mathbb{H}^3}$. For a discrete subgroup Γ of $\text{Isom}^+(\mathbb{H}^3)$, let $\Lambda(\Gamma)$ denote the limit set of Γ in S_∞^2 and let $\Omega(\Gamma) = S_\infty^2 - \Lambda(\Gamma)$ denote the regular set of Γ in S_∞^2 . A discrete, torsion-free subgroup Γ of $\text{Isom}^+(\mathbb{H}^3)$ is called *quasi-Fuchsian* if its limit set $\Lambda(\Gamma)$ in S_∞^2 is a Jordan circle and each of the

two components of $\Omega(\Gamma)$ is invariant under the action of Γ . In the special case that the Jordan circle is a geometric circle, the subgroup is said to be *Fuchsian*.

If M is a hyperbolic knot complement, then its fundamental group can be identified as a discrete torsion free subgroup Γ of $\text{Isom}^+(\mathbb{H}^3)$. A surface $f: S \rightarrow M$ in a hyperbolic knot manifold M is said to be

- (a) *quasi-Fuchsian* if it is essential and $f^*(\pi_1(S))$ is a quasi-Fuchsian subgroup of $\Gamma \subset \text{Isom}^+(\mathbb{H}^3)$; or
- (b) *geometrically infinite* if it is essential and the limit set of $f^*(\pi_1(S))$ is the entire S_∞^2 ; or
- (c) *essential with accidental parabolics* if it is essential and some non-peripheral element of $\pi_1(S)$ has a parabolic image in $f^*(\pi_1(S)) \subset \pi_1(M) \subset \text{Isom}^+(\mathbb{H}^3)$.

A quasi-Fuchsian surface $f: S \rightarrow M$ is further called a *Fuchsian* or *totally geodesic* surface if the map lifts to a totally geodesic plane in \mathbb{H}^3 with respect to the universal covering $\mathbb{H}^3 \rightarrow M$. In such case the image group $f^*(\pi_1(S))$ is a Fuchsian subgroup of $\text{Isom}^+(\mathbb{H}^3)$.

Work of Marden [13], Thurston [19] and Bonahon [4] implies that every essential surface falls into one of these categories. Another consequence of their work is that every geometrically infinite surface is homotopic to a virtual fiber. (It is still an open question whether every hyperbolic knot complement is virtually fibered.) In particular, if a *closed* essential surface in a hyperbolic knot complement has no accidental parabolics, then it is quasi-Fuchsian.

Examples of quasi-Fuchsian surfaces in hyperbolic knot complements have been scarce. It was shown by Cooper, Long and Reid [8] that every hyperbolic knot complement contains closed essential surfaces, but the surfaces constructed there (via Freedman tubing) always contain accidental parabolic elements. Similarly, the closed essential surfaces constructed in Oertel [16], Cooper–Long [6; 7] and Li [12], all contain accidental parabolics. It was shown by Menasco [15] that the complement of an alternating knot in S^3 contains no closed, *embedded* quasi-Fuchsian surface, a result which was extended in Adams [1]. On the positive side, there are well-known examples, such as the figure-eight knot complement, which contain closed, totally geodesic surfaces. Also, hyperbolic knot complements in S^3 which contain closed, embedded, quasi-Fuchsian surfaces are constructed in Adams and Reid [2]. In this paper we prove the following general existence theorem.

Theorem 1.1 *Every hyperbolic knot complement contains a closed quasi-Fuchsian surface.*

A closed quasi-Fuchsian surface in a hyperbolic knot complement M has the nice property that it remains essential in all but finitely many Dehn fillings of M (see, for example, Wu [20, Theorem 5.3]). [Theorem 1.1](#) thus has the following topological consequence:

Corollary 1.2 *Suppose that M is a hyperbolic knot complement. Then M contains a closed essential surface which remains essential in all but finitely many Dehn fillings of M .*

It was first shown in Cooper and Long [7], and later by a different method in Li [12], that for any hyperbolic knot complement M , all but finitely many Dehn fillings of M contain a closed essential surface. What's new in [Corollary 1.2](#) is that for every hyperbolic knot complement M , there is a *single* closed essential surface in M which survives all but finitely many Dehn fillings of M .

We wish to thank the referee for many helpful comments.

2 Outline of proof and plan of paper

Let M be a hyperbolic knot complement, and let C be a geometric cusp of M . The complement of the interior of C in M , which we denote by M^- , is a compact (connected and orientable) 3-manifold whose boundary is a torus. We call M^- the *truncated knot complement*. The idea is to construct a metrically complete convex hyperbolic 3-manifold Y with the following properties:

- (1) Y has non-empty boundary;
- (2) there is a local isometry f from Y into the knot complement M , and thus an injective homomorphism f^* of $\pi_1(Y)$ into $\pi_1(M)$ (by [Lemma 4.2](#));
- (3) Y has a single cusp, C_0 , such that:
 - (i) the fundamental group of C_0 is a free abelian group of rank two which injects into the fundamental group of Y under the inclusion map;
 - (ii) the image of $\pi_1(C_0)$ under the map f^* is a finite index subgroup of $\pi_1(C)$;
 - (iii) every Dehn filling of Y along the cusp C_0 results a compact 3-manifold which is ∂ -irreducible.

Restricting f to any boundary component of Y gives a closed surface in M , and the above properties imply that the surface is quasi-Fuchsian. The proof of this implication is given at the end of [Section 13](#).

To construct such a manifold Y , we start with a pair of (non-compact) embedded, quasi-Fuchsian surfaces S_i , $i = 1, 2$, in M such that $S_i^- = S_i \cap M^-$, $i = 1, 2$, are properly embedded essential surfaces with different boundary slopes on ∂M^- . The existence of such a pair of surfaces follows from work of Culler and Shalen [9]. Let n_i be the number of components of ∂S_i^- and let Δ be the geometric intersection number between a component of ∂S_1^- and a component of ∂S_2^- . The fundamental group of S_i can be naturally identified with a fixed quasi-Fuchsian subgroup Γ_i of $\Gamma = \pi_1(M)$. The limit set Λ_i of Γ_i is a Jordan circle in S_∞^2 . Let H_i be the convex hull of Λ_i in \mathbb{H}^3 , and let X_i be the ϵ -collared neighborhood of H_i in \mathbb{H}^3 for some fixed number $\epsilon > 0$. Then each of H_i and X_i is a convex 3-submanifold of \mathbb{H}^3 invariant under the action of Γ_i . Let $Y_i = X_i / \Gamma_i$. Then Y_i is a metrically complete convex hyperbolic 3-manifold with a local isometry f_i into M . Topologically Y_i is a product I -bundle over S_i , ie $Y_i = S_i \times I$. We have the corresponding truncated I -bundle $Y_i^- = S_i^- \times I$. The ‘‘cusp region’’ of Y_i has a standard shape if the geometric cusp C of M is chosen small enough. In particular, the parabolic boundary $\partial_p Y_i^- \equiv \partial S_i^- \times I$, is a set of n_i standard Euclidean annuli.

To illustrate how Y is constructed, let us make some simplifying assumptions. Suppose that each S_i is totally geodesic, that Y_i^- is an ϵ -neighborhood of S_i^- , embedded in M , and that $S_1^- \cap S_2^-$ has a large collar neighborhood in both S_1^- and S_2^- . In this case, we construct Y as an embedded sub-manifold of M . Consider $Y_1^- \cup Y_2^-$, which is a sub-manifold of M^- . The boundary of this submanifold is convex, except along the ‘‘corners’’ ($\partial Y_1^- \cap \partial Y_2^-$), and along the truncated cusp. Since we have assumed that the components of $S_1^- \cap S_2^-$ are well spread out, there is enough room to smooth out the corners, as illustrated in Figure 1 (which shows the part of the smoothing near $\partial_p Y_1^- \cup \partial_p Y_2^- \subset \partial M^-$). We thus obtain a truncated sub-manifold, $Y^- \subset M^-$, whose frontier is convex. The complement of $\text{int } Y^-$ in ∂M^- consists of a finite number of disks, and the convex hull of each disk is a compact subset of the cusp C . We scoop out each of these convex sets from C to form a new cusp C_0 . The manifold Y is the union of Y^- and C_0 .

In general, we cannot hope for the manifolds Y_i^- to be embedded in M^- , and so we must construct Y in a more abstract way. We wish to identify Y_1^- and Y_2^- along certain isometric embedded submanifolds $K_i^- \subset Y_i^-$, which correspond to ‘‘intersection’’ components of Y_1^- and Y_2^- . We then wish to smooth out the corners to form a hyperbolic 3-manifold Y^- which is locally convex everywhere except on its ‘‘parabolic boundary’’ $\partial_p Y^-$. Then we wish to attach a cusp C_0 along $\partial_p Y^-$ to form the required manifold Y .

The gluing and smoothing operations are well-known in the totally geodesic case, but to make them work for quasi-Fuchsian surfaces is more difficult. Furthermore, the gluing

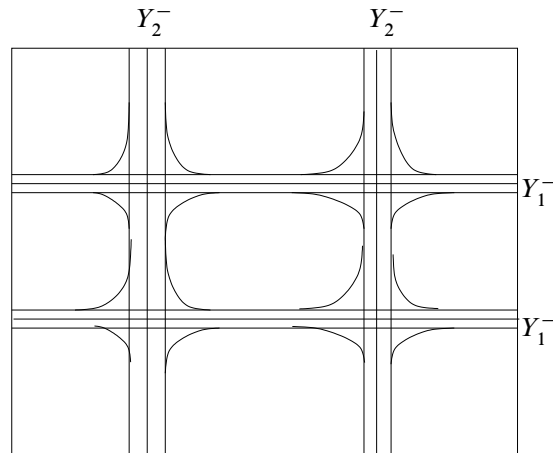

Figure 1

can only be performed on manifolds with sufficient “room”. Thus it may be necessary to replace the given manifolds Y_i^- with suitable finite covers \check{Y}_i^- . We construct such covers by proving that free groups satisfy a strengthened form of the LERF property.

In [Section 4](#), we collect some general facts about hyperbolic geometry. Of particular importance is a general fact about convex hulls in hyperbolic space ([Proposition 4.5](#)), which is essential for our gluing constructions. In [Section 5](#), we give some general facts about cusped, quasi-Fuchsian surfaces, and their convex cores.

In [Section 6](#), we construct the “gluing manifolds” K_1^- and K_2^- . In the case where each Y_i^- is embedded in M^- , then $K_i^- \subset Y_i^-$ is just the intersection $Y_1^- \cap Y_2^-$. In general, the fundamental group of each component of K_i^- is identified with the intersection of some conjugate of $\Gamma_1 = f^* \pi_1 S_1^-$ and some conjugate of $\Gamma_2 = f^* \pi_1 S_2^-$, and there is an immersion $g_i: K_i^- \rightarrow Y_i^-$.

The gluing must occur along *embedded* sub-manifolds of Y_i^- , and so we must lift g_i to an embedding. For this purpose, it will be useful to isometrically embed K_i^- into a *connected* hyperbolic manifold J_i^- , whose boundary is convex, outside of a compact set of parabolic regions, and which has a local isometry map (still denoted g_i) into Y_i^- . The construction of J_i^- is contained in [Section 7](#).

We also wish to control how the parabolic boundary of J_i^- is located in ∂Y_i^- under the local isometry $g_i: J_i^- \rightarrow Y_i^-$, and for this purpose we embed J_i^- isometrically into a certain compact, convex hyperbolic manifold $C_n(J_i^-)$. We also extend g_i to a local isometry $g_i: C_n(J_i^-) \rightarrow Y_i^-$. The construction of $C_n(J_i^-)$ is contained in [Section 8](#).

Free groups are LERF, and so, using standard arguments, it is possible to find a finite cover \check{Y}_i of Y_i such that the map $g_i: C_n(J_i^-) \rightarrow Y_i$ lifts to an embedding. However, for our construction, we require the corresponding truncated cover $\check{Y}_i^- = \check{S}_i^- \times I$ to have the same number of parabolic boundary components as that of Y_i^- . Thus we must show that free groups satisfy a strengthened version of the LERF Property. This is done in [Section 9](#). The proof of this stronger LERF property requires much more work than the classical LERF property, and may be of independent group theoretic interest. The proof applies Stallings' graph-folding techniques.

Finally we need to impose one more technical condition on the covers \check{Y}_i . We require that, after the gluing, $\partial_p \check{Y}_1^- \cup \partial_p \check{Y}_2^-$ is isometric to an embedded grid in a certain finite cover \check{T} of the Euclidean torus ∂C . The exterior of the grid should be a set of Euclidean parallelograms with long sides. This requires a further strengthening of the LERF property for free groups, which is carried out in [Section 11](#).

With this property achieved, we can cap off Y^- with a hollowed solid cusp C_0 along $\partial_p Y^-$ to get a metrically complete convex hyperbolic 3-manifold Y , with non-empty boundary, with a single cusp, and with a local isometry into M . Thus Y already has the required properties (1) and (2) given above. To show Y has the property (3), we show that any Dehn filling $Y(\alpha)$ of Y with slope α can be decomposed, in a specified way, into handlebody and I -bundle pieces. We call such manifold an HS-manifold. In [Section 12](#) we show that if an HS-manifold satisfies certain conditions then its boundary is incompressible.

Our last step is to show that the HS-manifold structure of $Y(\alpha)$ satisfies these conditions for incompressibility. The final assembly of Y , and the proof that Y has all the required properties, are given in [Section 13](#).

We remark that Baker and Cooper have recently obtained results on gluing convex hyperbolic manifolds [\[3\]](#), which overlap with some of our gluing results, for example in [Section 4](#).

3 Conventions

In this paper, all manifolds shall be assumed orientable by default. Any 0-codimension submanifold of an oriented manifold is given the induced orientation in the obvious way. If \tilde{W} is a covering space of an oriented manifold W , then the induced orientation for \tilde{W} is the one which makes the covering map orientation preserving. If W is an oriented n -manifold ($n \geq 1$) with boundary, then its boundary ∂W is given the induced orientation according the following rule: at each point of ∂W , the induced orientation

of ∂W followed by an inward pointing tangent vector of W gives the orientation of W at that point.

Suppose that U_i is a submanifold of a manifold V_i , $i = 1, 2$, then a map of pairs $f: (V_1, U_1) \rightarrow (V_2, U_2)$ is called *proper* if the pre-image of any compact set is compact, and if $f(U_1) \subset U_2$.

If V is a hyperbolic 3-manifold, then for any submanifold U of V (in particular ∂V), each component of U is considered as a metric space with the induced path metric. If \tilde{V} is a connected covering space of V , then \tilde{V} is given the induced metric so that the covering map from \tilde{V} to V is a local isometry.

If V is a metric space and U is a subset of V , then $V - U$ denotes the complement of U in V , and $V \setminus U$ denotes the set obtained by first taking the topological closure of individual components of $V - U$ in V and then taking the disjoint union of these closures.

We say a connected subspace U of a space V carries the fundamental group of V if the inclusion $U \subset V$ induces a surjective homomorphism on the fundamental groups.

4 Some properties of convex hyperbolic 3-manifolds

For standard definitions and facts about hyperbolic manifolds (possibly with boundary), the limit set, the convex hull, the developing map, the holonomy representation, etc, we take Canary–Epstein–Green [5], Epstein–Marden [10] and Ratcliffe [17] as references.

For any subset W of \mathbb{H}^3 , the *limit set* of W in S_∞^2 , denoted $\Lambda(W)$, is the set of intersection points (possibly empty) between the closure of W in $\overline{\mathbb{H}^3}$ and S_∞^2 .

Let V be an orientable, metrically complete, convex (thus connected) hyperbolic 3-manifold (possibly with boundary), with base point $v_0 \in V$. Then its universal cover \tilde{V} is also a metrically complete, convex, hyperbolic 3-manifold, and the developing map $D: \tilde{V} \rightarrow \mathbb{H}^3$ is an isometry of \tilde{V} onto its image [5, Proposition 1.4.2]. It follows that the holonomy representation ρ of $\pi_1(V, v_0)$ into $PSL_2(\mathbb{C})$ is a discrete and faithful representation with no nontrivial elliptic elements in the image. The image group $\Gamma = \rho(\pi_1(V, v_0))$ acts on $D(\tilde{V})$ as a covering transformation group. So we may consider \tilde{V} as a submanifold of \mathbb{H}^3 and consider V as the quotient space of \tilde{V} under the action of Γ . Let $p: \tilde{V} \rightarrow V$ be the quotient map, which is a universal covering map, and let $\tilde{v}_0 \in \tilde{V}$ be a fixed point in $p^{-1}(v_0)$. Then the fundamental group $\pi_1(V, v_0)$ can be identified with Γ in the following way. Let $\alpha: ([0, 1], \partial[0, 1]) \rightarrow (V, v_0)$ be a loop in V , based at v_0 , representing a nontrivial element α_* of $\pi_1(V, v_0)$, and let

$\tilde{\alpha}: ([0, 1], 0) \rightarrow (\tilde{V}, \tilde{v}_0)$ be the unique lift of α based at the point \tilde{v}_0 with respect to the covering map $p: (\tilde{V}, \tilde{v}_0) \rightarrow (V, v_0)$. Then the element of Γ corresponding to α_* is the one which maps \tilde{v}_0 to $\tilde{\alpha}(1)$.

A nontrivial element γ of $\pi_1(V, v_0)$ is said to be hyperbolic or parabolic if $\rho(\gamma) \in \Gamma$ is hyperbolic or parabolic, respectively, in the usual sense; ie γ has exactly two fixed points or one fixed point, respectively, in $\overline{\mathbb{H}^3}$. This definition is independent of the choices for base points.

Let V be a hyperbolic 3-manifold and v_0 a point in V . We define a *geodesic loop in V based at v_0* to be a loop $\alpha: ([0, 1], \partial[0, 1]) \rightarrow (V, v_0)$, which is geodesic when restricted to $(0, 1)$. Throughout this paper, a geodesic is always assumed to be non-constant.

Lemma 4.1 *Let V be an orientable, metrically complete, convex, hyperbolic 3-manifold (possibly with boundary), and $v_0 \in V$ a base point. Then every nontrivial element in $\pi_1(V, v_0)$ is represented uniquely by a geodesic loop in V based at v_0 .*

Proof We identify \tilde{V} , the universal cover of V , as a metrically complete, convex submanifold of \mathbb{H}^3 , and let $p: \tilde{V} \rightarrow V$ be the covering map. Fix a point \tilde{v}_0 in $p^{-1}(v_0)$ as the base point of \tilde{V} . For a given nontrivial element $\gamma \in \pi_1(V, v_0)$, let $\alpha: [0, 1] \rightarrow V$ be a loop in V based at v_0 (ie $\alpha(0) = \alpha(1) = v_0$) representing γ . Let $\tilde{\alpha}: [0, 1] \rightarrow \tilde{V}$ be the unique lift of α with $\tilde{\alpha}(0) = \tilde{v}_0$. Since α represents a nontrivial element of $\pi_1(V, v_0)$, $\tilde{\alpha}(0) \neq \tilde{\alpha}(1)$. Let $\tilde{\sigma}: [0, 1] \rightarrow \mathbb{H}^3$ be the unique geodesic segment with $\tilde{\sigma}(0) = \tilde{\alpha}(0) = \tilde{v}_0$ and $\tilde{\sigma}(1) = \tilde{\alpha}(1)$. Since \tilde{V} is convex, the geodesic path $\tilde{\sigma}$ is contained in \tilde{V} . Thus the map $\sigma = p \circ \tilde{\sigma}: [0, 1] \rightarrow V$ gives a geodesic loop in V based at v_0 . By convexity, the convex hull of the set $\tilde{\alpha}([0, 1]) \cup \tilde{\sigma}([0, 1])$ is contained in \tilde{V} , and this hull contains a homotopy between $\tilde{\alpha}$ and $\tilde{\sigma}$ with their endpoints fixed. Under the covering map p , the homotopy descends to a homotopy in V between the loop α and the geodesic loop σ fixing the base point v_0 . Hence σ is also a representative loop of the element γ . The uniqueness of such a based geodesic loop is clear from the argument. \square

Lemma 4.2 *Suppose that $f: U \rightarrow V$ is a local isometry between two 3-manifolds U and V which are orientable, metrically complete, convex and hyperbolic. Then $f^*: \pi_1(U, u_0) \rightarrow \pi_1(V, f(u_0))$ is injective for any choice of the base point u_0 in U . If in addition U is compact, then $f^*(\pi_1(U, u_0))$ contains no parabolic elements of $\pi_1(V, f(u_0))$.*

Proof Let $v_0 = f(u_0)$, let $p: \tilde{V} \rightarrow V$ be the universal covering map, where \tilde{V} is identified as a submanifold of \mathbb{H}^3 , and let \tilde{v}_0 be a fixed point in $p^{-1}(v_0)$. To prove

the first assertion, let γ be a nontrivial element of $\pi_1(U, u_0)$. By Lemma 4.1, γ is represented by a geodesic loop σ in U based at u_0 . Since f is a local isometry, $f \circ \sigma$ is a geodesic loop in V based at v_0 . If $f^*(\gamma)$ is the trivial element of $\pi_1(V, v_0)$, then $f \circ \sigma$ lifts to a geodesic loop in \tilde{V} based at \tilde{v}_0 . But obviously \mathbb{H}^3 contains no based geodesic loops. Hence $f^*(\gamma)$ is nontrivial in $\pi_1(V, v_0)$, and thus f^* is injective.

Now suppose in addition that U is compact. Let $H = f^*(\pi_1(U, u_0))$. Let $\bar{V} = \tilde{V}/H$, and let $\bar{q}: (\tilde{V}, \tilde{v}_0) \rightarrow (\bar{V}, \bar{q}(\tilde{v}_0))$, $\bar{p}: (\bar{V}, \bar{q}(\tilde{v}_0)) \rightarrow (V, v_0)$ be the covering maps. Since $\bar{p}^*(\pi_1(\bar{V}, \bar{q}(\tilde{v}_0))) = f^*(\pi_1(U, u_0)) = H$, the map $f: (U, u_0) \rightarrow (V, v_0)$ lifts to a map $\bar{f}: (U, u_0) \rightarrow (\bar{V}, \bar{q}(\tilde{v}_0))$. Since $\bar{p} \circ \bar{f} = f$ and since \bar{p} and f are local isometries, \bar{f} is a local isometry.

Let $p': (\tilde{U}, \tilde{u}_0) \rightarrow (U, u_0)$ be the universal covering map. Then the map $\bar{f} \circ p'$ lifts to a map $\tilde{f}: (\tilde{U}, \tilde{u}_0) \rightarrow (\tilde{V}, \tilde{v}_0)$. Since $\tilde{f} \circ p' = \bar{q} \circ \bar{f}$ and since \bar{q}, p', \bar{f} are all local isometries, \tilde{f} is also a local isometry. Hence \tilde{f} sends geodesic arcs to geodesic arcs. Since \tilde{U} is convex and since \tilde{V} is a simply connected submanifold of \mathbb{H}^3 , \tilde{f} must be an embedding. Since the map \tilde{f} is equivariant and the map f^* is an isomorphism, from the commutative diagram:

$$\begin{array}{ccc} (\tilde{U}, \tilde{u}_0) & \xrightarrow{\tilde{f}} & (\tilde{V}, \tilde{v}_0) \\ p' \downarrow & & \downarrow \bar{q} \\ (U, u_0) & \xrightarrow{\bar{f}} & (\bar{V}, \bar{q}(\tilde{v}_0)) \end{array}$$

we see that \bar{f} is an embedding. Hence $\tilde{f}(\tilde{U})$ is a convex submanifold of \tilde{V} covering the compact submanifold $\bar{f}(U)$ of \bar{V} . In fact, $\tilde{f}(\tilde{U})/H = \bar{f}(U)$.

If $H = f^*(\pi_1(U, u_0))$ contains parabolic elements, then a standard hyperbolic geometry argument shows that $\bar{f}(U)$ contains a non-compact cusp end. In fact if H_0 is a nontrivial maximal parabolic subgroup of H and if $a \in S_\infty^2$ is the point fixed by H_0 , then there is a horoball B_a of \mathbb{H}^3 , based at a , such that $(B_a \cap \tilde{f}(\tilde{U}))/H_0$ properly embeds into $\bar{f}(U)$ as a non-compact end. This is a contradiction, since $\bar{f}(U)$ is compact. □

Every metrically complete, convex subset of \mathbb{H}^3 is a manifold (Epstein–Marden [10, Theorem 1.4.3]). Obviously the intersection of two metrically complete, convex submanifolds of a metrically complete, convex 3–manifold is a metrically complete, convex submanifold (when non-empty). Every metrically complete, convex 3–submanifold U of a simply connected, metrically complete, convex, hyperbolic 3–manifold V is simply connected (which follows from Lemma 4.2). A metrically complete, hyperbolic

3–manifold (possibly with boundary) is convex or strictly convex if and only if it is everywhere locally convex or locally strictly convex, respectively (Canary–Epstein–Green [5, Corollary 1.3.7]). These facts will be often used in this paper.

Let V be a connected metric space and U a subspace of V (possibly disconnected). By an r –neighborhood of U in V , denoted $N_{(r,V)}(U)$, we mean the set of points in V whose distance from U is less than or equal to r . Note that the topology of $N_{(r,V)}(U)$ may be different from that of U . An r –neighborhood $N_{(r,V)}(U)$ is further called an r –collared neighborhood of U in V if, under a universal covering map $p: \tilde{V} \rightarrow V$, the components of $p^{-1}(U)$ are more than distance $2r$ apart from each other. When the ambient space V is clear, we simply write $N_r(U)$ for $N_{(r,V)}(U)$. The following lemma follows directly from the definition.

Lemma 4.3 *If V is a simply connected hyperbolic manifold and U a connected submanifold of V , then for any $r > 0$, $N_{(r,V)}(U)$ is an r –collared neighborhood of U in V .*

We also need to define “ r –collared neighborhood” in relative version, as follows. Let V be a connected, hyperbolic manifold with boundary and F a submanifold of ∂V (possibly with infinitely many components). Suppose that U is a submanifold of V and let $E = \partial U \cap F$ (which possibly has infinitely many components). If there is an r –collared neighborhood $N_{(r,V)}(U)$ of U in V such that for each component F_i of F , $N_{(r,V)}(U) \cap F_i$ is an r –collared neighborhood of $E \cap F_i$ in F_i (where F_i is given the induced metric as a submanifold of V), then we say that the pair (U, E) has an r –collared neighborhood in the pair (V, F) . Again directly from the definition we have the following lemma.

Lemma 4.4 *Suppose that V is a simply connected hyperbolic manifold and F a submanifold of ∂V such that each component of F is simply connected. Suppose that U is a connected submanifold of V and suppose that for each component F_i of F , $F_i \cap \partial U$ is a connected submanifold of F_i . Then for any $r > 0$, the pair $(U, \partial U \cap F)$ has an r –collared neighborhood in the pair (V, F) .*

For a metrically complete, convex submanifold $V \subset \mathbb{H}^3$ and a point v in the frontier of V in \mathbb{H}^3 , we use $P_{(v,V)}$ to denote a support plane for V at the point v , ie $P_{(v,V)}$ is a hyperbolic plane in \mathbb{H}^3 such that V lies on one side of the plane and such that $V \cap P_{(v,V)}$ contains the point v . A supporting plane always exists [10, Lemma 1.4.5]. Let ϵ be a fixed positive number. For a metrically complete, convex submanifold V in \mathbb{H}^3 , the ϵ –collared neighborhood of V in \mathbb{H}^3 , $N_\epsilon(V)$, is a metrically complete and strictly convex [10, Lemma 1.4.7] 3–dimensional submanifold of \mathbb{H}^3 , with C^1

boundary [10, Lemma 1.3.6]. Note that the supporting plane of $N_\epsilon(V)$ at a point x in the frontier of $N_\epsilon(V)$ (which is $\partial N_\epsilon(V)$ in this case) is unique, and intersects $N_\epsilon(V)$ only at the point x , due to the strict convexity of $N_\epsilon(V)$.

The following proposition will play a key role.

Proposition 4.5 *For any given $\epsilon > 0$, there is a number $R = R(\epsilon) > 0$ such that the following holds. If V and V' are metrically complete, convex submanifolds of \mathbb{H}^3 such that $N_\epsilon(V)$ and V' have non-empty intersection, and if x is a point in $\partial N_\epsilon(V)$ such that $d(x, N_\epsilon(V) \cap V') > R$, then $P_{(x, N_\epsilon(V))} \cap V' = \emptyset$. In particular if we take the convex hull of the union of $N_\epsilon(V)$ and $N_\epsilon(V')$ then all the added points are contained in an R -collared neighborhood of $N_\epsilon(V) \cap N_\epsilon(V')$.*

Proof Suppose otherwise that such R does not exist. Let $x \in \partial(N_\epsilon(V))$ be a point very far from $N_\epsilon(V) \cap V'$, let A be a geodesic segment, tangent to $N_\epsilon(V)$ at x , contained in the unique supporting plane $P_{(x, N_\epsilon(V))}$, and suppose that $A \cap V'$ contains a point x' .

If $\partial(N_\epsilon(V)) \cap V' = \emptyset$, then $V' \subset \text{int } N_\epsilon(V)$, and so $P_{(x, N_\epsilon(V))} \cap V' = \emptyset$. Thus, we may assume that $\partial(N_\epsilon(V)) \cap V'$ contains a point w . Since every component of $\partial N_\epsilon(V)$ separates \mathbb{H}^3 , we may assume that w and x are in the same component of $\partial N_\epsilon(V)$. Let B be a geodesic segment from x' to w , let C be a geodesic segment from w to x , and let P_0 be the unique geodesic plane containing the (distinct) points x, x' and w . See Figure 2.

Let x_1 and w_1 be the nearest points in V to x and w respectively, let C_1 be a geodesic segment from x_1 to w_1 , and let E be the geodesic rectangle in \mathbb{H}^3 with vertices x, x_1, w_1 and w . Since E bounds a surface of area less than 2π , then if C and C_1 are long enough, most of the arc C is very close to C_1 ; for example, we may assume that:

$$(4-1) \quad \text{Length}(C \cap N_{.01\epsilon}(C_1)) \geq .99 \text{Length}(C)$$

Now let D be the segment of the curve $P_0 \cap \partial(N_\epsilon(V))$ which runs from x to w . Since $D \subset \partial N_\epsilon V$, and $C_1 \subset V$, then:

$$(4-2) \quad N_\epsilon C_1 \cap D = \emptyset$$

By (4-1) and (4-2), we have:

$$(4-3) \quad \text{Length}(C - N_\epsilon D) \geq .99 \text{Length}(C)$$

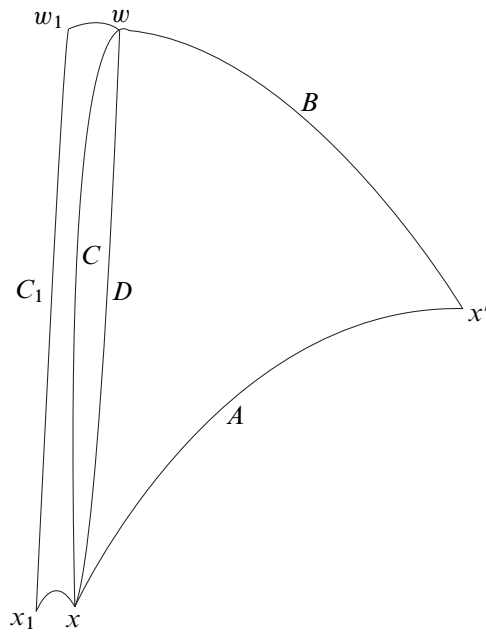

Figure 2: If C is long, the area between C and D becomes large.

By (4–3) and a simple integration, the area in P_0 bounded by C and D is at least $.99 \text{Length}(C) * .99\epsilon$. But since this region is contained in the triangle region ABC , its area must be less than π , which is a contradiction if C is long enough. \square

In a similar vein, we have:

Proposition 4.6 *Suppose that X is a convex submanifold of \mathbb{H}^3 , that V_1, \dots, V_n are convex subsets of X , and that $N_{(\epsilon, X)}(V_1), \dots, N_{(\epsilon, X)}(V_n)$ are all disjoint, for some $\epsilon > 0$. Then $\text{Hull}(N_{(\epsilon, X)}(V_1) \cup \dots \cup N_{(\epsilon, X)}(V_n)) \setminus (N_{(\epsilon, X)}(V_1) \cup \dots \cup N_{(\epsilon, X)}(V_n))$ is compact.*

Proof We first note that for any convex subset V of X , $N_{(\epsilon, X)}(V) = N_\epsilon(V) \cap X$ and that $\partial N_{(\epsilon, X)}(V) \cap \text{int } X = \partial N_\epsilon(V) \cap \text{int } X$.

For every x in $\partial N_{(\epsilon, X)}(V_i) \cap \text{int } X$, there is a geodesic plane P_x , such that $P_x \cap N_{(\epsilon, X)}(V_i) = \{x\}$. Let $\epsilon' > 0$ be a number such that $N_{(\epsilon, X)}(V_i) \cap N_{(\epsilon', X)}(V_j) \neq \emptyset$ for all $1 \leq i, j \leq n$. Since $N_{(\epsilon, X)}(V_i)$ and $N_{(\epsilon, X)}(V_j)$ are disjoint, the limit set of $N_{(\epsilon, X)}(V_i)$ is disjoint from the limit set of $N_{(\epsilon, X)}(V_j)$. Thus $N_{(\epsilon, X)}(V_i) \cap N_{(\epsilon', X)}(V_j)$ is compact in \mathbb{H}^3 . The proof of Proposition 4.5 shows that there is a compact subset

$B_i \subset N_{(\epsilon, X)}(V_i)$ such that for all $x \in (\partial N_{(\epsilon, X)}(V_i) \setminus B_i) \cap \text{int}(X)$, we have $P_x \cap N_{\epsilon'}(V_j) = \emptyset$ for each $j \neq i$. It follows that $\text{Hull}(N_{(\epsilon, X)}(V_1) \cup \dots \cup N_{(\epsilon, X)}(V_n)) \setminus (N_{(\epsilon, X)}(V_1) \cup \dots \cup N_{(\epsilon, X)}(V_n))$ has no limit points in S_∞^2 and thus is compact. \square

Let Γ be a group, $H \subset \Gamma$ a subgroup, and γ an element in $\Gamma - H$. We say that H is *separable* from γ in Γ if there exists a finite index subgroup G of Γ such that G contains H but does not contain γ . If H is separable from every element in $\Gamma - H$, then H is said to be separable in Γ . It is easy to see that if H is separable in Γ , then given any finite set of elements y_1, \dots, y_a in $\Gamma - H$, there is a finite index subgroup G of Γ such that G contains H but does not contain any of y_1, \dots, y_a .

Proposition 4.7 *Let U be a compact, convex, hyperbolic 3-manifold, let V be a metrically complete, convex, hyperbolic 3-manifold and let $f: (U, u_0) \rightarrow (V, v_0)$ be a local isometry. Then there is a finite (possibly empty) set of elements y_1, \dots, y_a in $\pi_1(V, v_0) - f^*(\pi_1(U, u_0))$ with the following property: if $G \subset \Gamma = \pi_1(V, v_0)$ is a finite index subgroup which separates $H = f^*(\pi_1(U, u_0))$ from y_1, \dots, y_a , and if \bar{V} is the finite cover of V corresponding to G , then the map $f: (U, u_0) \rightarrow (V, v_0)$ lifts to an embedding $\check{f}: U \rightarrow \bar{V}$.*

Proof Let $p: (\tilde{V}, \tilde{v}_0) \rightarrow (V, v_0)$ and $p': (\tilde{U}, \tilde{u}_0) \rightarrow (U, u_0)$ be the universal covering maps, let $\bar{V} = \tilde{V}/H$, and let $\bar{q}: (\tilde{V}, \tilde{v}_0) \rightarrow (\bar{V}, \bar{q}(\tilde{v}_0))$ and $\bar{p}: (\bar{V}, \bar{q}(\tilde{v}_0)) \rightarrow (V, v_0)$ be the covering maps. As in the proof of Lemma 4.2, we have the commutative diagrams:

$$\begin{array}{ccc}
 (\tilde{U}, \tilde{u}_0) & \xrightarrow{\tilde{f}} & (\tilde{V}, \tilde{v}_0) \\
 p' \downarrow & & \downarrow \bar{q} \\
 (U, u_0) & \xrightarrow{\bar{f}} & (\bar{V}, \bar{q}(\tilde{v}_0)) \\
 & \searrow f & \swarrow \bar{p} \\
 & (V, v_0) &
 \end{array}$$

where both \tilde{f} and \bar{f} are embeddings, such that $\tilde{f}(\tilde{U})$ is a simply connected convex submanifold of \tilde{V} covering $\bar{f}(U)$ with covering group H . Since $\bar{f}(U)$ is compact, there is a connected compact submanifold D in \tilde{V} such that $\bar{q}(D)$ contains $\bar{f}(U)$. Since the action of $\Gamma = \pi_1(V, v_0)$ on \tilde{V} is properly discontinuous, there are only finitely many elements γ of Γ with $D \cap \gamma(D) \neq \emptyset$. Let y_1, \dots, y_a be all such elements which are not contained in H . Suppose that G is a finite index subgroup of Γ such that G contains H but does not contain any of y_1, \dots, y_a . Let $\check{V} = \bar{V}/G$. Then the covering map $\check{q}: (\bar{V}, \bar{q}(\tilde{v}_0)) \rightarrow (\check{V}, \check{q}(\bar{q}(\tilde{v}_0)))$ embeds $\bar{f}(U)$ into \check{V} . Let

$\check{p}: (\check{V}, \check{q}(\check{q}(\check{v}_0))) \rightarrow (V, v_0)$ be the finite covering map. One can easily check that $f = \check{p} \circ \check{q} \circ \check{f}$ (since $f = \bar{p} \circ \bar{f}$ and $\bar{p} = \check{p} \circ \check{q}$). Hence $\check{f} = \check{q} \circ \check{f}: (U, u_0) \rightarrow (\check{V}, \check{q}(\check{q}(\check{v}_0)))$ is a lift of the map $f: (U, u_0) \rightarrow (V, v_0)$ such that \check{f} is an embedding. \square

5 Cusped quasi-Fuchsian surfaces and their convex cores

Recall that M denotes an arbitrary fixed, connected, orientable, complete, finite-volume, hyperbolic 3-manifold with a single cusp. We consider M as the quotient space of \mathbb{H}^3 under the action of a fixed, discrete, torsion-free subgroup Γ of $PLS_2(\mathbb{C})$. A point $a \in S_\infty$ is called a *parabolic fixed point* of a subgroup of Γ if a is the fixed point of a parabolic element of the subgroup (note that the trivial element is not considered as a parabolic element). We may assume that the point ∞ is a parabolic fixed point of Γ (up to replacing Γ by a conjugate of Γ in $PSL_2(\mathbb{C})$, which we may assume has been done). The quotient map $p: \mathbb{H}^3 \rightarrow M = \mathbb{H}^3/\Gamma$ is a fixed universal covering map of M . Note that Γ acts on \mathbb{H}^3 isometrically as the covering transformation group, and p is a local isometry. Also Γ is isomorphic to the fundamental group of M .

Let C be an embedded geometric cusp in M , ie $\mathcal{B} = p^{-1}(C)$ is a set of mutually disjoint horoballs in \mathbb{H}^3 invariant under the action of Γ . Later, we may need to shrink C if necessary to satisfy some extra conditions. Note that each component of \mathcal{B} is based at a parabolic fixed point of Γ , and in this fashion the set of parabolic fixed points of Γ is in one-to-one correspondence with the set of components of \mathcal{B} . Also the set of parabolic fixed points of Γ is invariant under the action of Γ , and the action is transitive (since M has a single cusp). Hence all components of \mathcal{B} are mutually isometric to each other by an element of Γ .

Let M^- be the complement of the interior of C in M . By Culler–Shalen [9] and Cooper–Long [7] there are two connected, embedded, orientable, cusped, quasi-Fuchsian surfaces S_i in M , such that $S_i^- = S_i \cap M^-$, $i = 1, 2$, have different boundary slopes (we may assume that $S_i \cap \partial M^-$ is a set of embedded simple closed curves each being essential in the torus ∂M^-). Let n_i be the number of cusps in S_i , ie n_i is the number of components of ∂S_i^- . By a well-known duality argument, at least one of the surfaces S_i must have even number of boundary components, ie at least one of the integers n_i must be even.

Let \tilde{S}_i be a fixed component of $p^{-1}(S_i) \subset \mathbb{H}^3$ whose closure in $\overline{\mathbb{H}^3}$ contains the point ∞ . Let $\text{Stab}_\Gamma(\tilde{S}_i)$ denote the maximal subgroup of Γ which leaves \tilde{S}_i invariant. Then there is a finite-index subgroup Γ_i of $\text{Stab}_\Gamma(\tilde{S}_i)$ such that $\tilde{S}_i/\Gamma_i = S_i$ and Γ_i is isomorphic to the fundamental group of S_i . As Γ_i is a quasi-Fuchsian subgroup, the limit set Λ_i of Γ_i is a Jordan circle in S_∞^2 , containing the point ∞ (by our choice).

Let H_i be the convex hull of Λ_i in \mathbb{H}^3 . Note that H_i is invariant under the action of Γ_i .

Lemma 5.1 [7] *The convex hull H_i lies between two parallel vertical planes in \mathbb{H}^3 .*

The two vertical planes given by Lemma 5.1 are based on two parallel Euclidean lines in \mathbb{C} . Among all pairs of planes satisfying Lemma 5.1, let $P_{i,j}$, $j = 1, 2$, be the pair which are closest to each other; thus H_i lies between $P_{i,1}$ and $P_{i,2}$, and $P_{i,j} \cap H_i$ is non-empty for each $j = 1, 2$. Let W_i be the closed 3-dimensional region between the two planes $P_{i,1}$ and $P_{i,2}$. Let B_∞ be the component of \mathcal{B} based at the point ∞ . So ∂B_∞ is a horizontal, Euclidean plane in \mathbb{H}^3 , and $W_i \cap \partial B_\infty$ is a strip – ie a region bounded by parallel lines in a Euclidean plane. Furthermore, $W_i \cap B_\infty$ is the product of the strip $W_i \cap \partial B_\infty$ with $[0, \infty)$; we call this a 3-dimensional strip region, based on $W_i \cap \partial B_\infty$.

Lemma 5.2 *If the cusp C of M is small enough, or equivalently if the horizontal plane ∂B_∞ is high enough (ie its Euclidean distance from the complex plane \mathbb{C} is big enough), then $H_i \cap B_\infty = W_i \cap B_\infty$.*

Proof Since H_i is convex, we just need to show that if the horizontal plane ∂B_∞ is high enough, then $P_{i,j} \cap B_\infty$ is contained in H_i for both $j = 1, 2$. We prove this for $j = 1$; the $j = 2$ case being entirely similar. Each of H_i , W_i , $P_{i,1}$ is invariant under the action of some parabolic element β_i of Γ_i , which is a horizontal Euclidean translation. Let x be a point in $H_i \cap P_{i,1}$. Then $\beta_i(x)$ is also contained in $H_i \cap P_{i,1}$, and so is the hyperbolic geodesic segment α in $P_{i,1}$ with endpoints x and $\beta_i(x)$. Since ∞ is a limit point of H_i , every vertical ray in \mathbb{H}^3 based at a point in H_i is entirely contained in H_i . So the part of $P_{i,1}$ lying directly above α is contained in $H_i \cap P_{i,1}$. So all the translations of this set under powers of β_i are contained in $H_i \cap P_{i,1}$. So it is clear that if ∂B_∞ is higher than the highest point of the geodesic segment α , then $P_{i,1} \cap B_\infty$ is contained in H_i . \square

Note that the center line of the strip $H_i \cap \partial B_\infty$ has the same slope as that of ∂S_i^- ; that is, its image under the covering map $p: \mathbb{H}^3 \rightarrow M$ is a simple closed curve in ∂M^- isotopic to a boundary component of S_i^- .

Now let B_a be any fixed component of \mathcal{B} based at a parabolic fixed point a of Γ_i , and let $\gamma \in \Gamma$ be any fixed element which maps a to ∞ . Then $\gamma(B_a) = B_\infty$. Consider the convex set $\gamma(H_i)$. As in Lemma 5.2, one can show that, after shrinking C if necessary, $\gamma(H_i) \cap B_\infty$ is a 3-dimensional strip region, based on a strip in ∂B_∞ . Note that the center line of the strip $\gamma(H_i) \cap \partial B_\infty$ is parallel to the center line of the strip $H_i \cap \partial B_\infty$, since the boundary curves of S_i^- are all isotopic in ∂M_i^- .

Lemma 5.3 *Up to replacing the cusp C by a smaller geometric cusp, $\gamma(H_i) \cap B_\infty$ is a 3-dimensional strip region, for every $\gamma \in \Gamma$ which sends a parabolic fixed point of Γ_i to ∞ . Moreover the center line of the strip $\gamma(H_i) \cap \partial B_\infty$ is parallel to the center line of the strip $H_i \cap \partial B_\infty$.*

Proof The lemma follows from the notes given in the preceding paragraph, together with the facts that the set of parabolic fixed points of Γ_i is invariant under the action of Γ_i and that the action has only finitely many orbits (exactly n_i orbits in fact). \square

From now on we assume that the cusp C of M has been chosen small enough so that the conclusion of Lemma 5.3 holds.

Fix a small positive number ϵ (eg $\epsilon = 1$) and let X_i be the ϵ -collared neighborhood of H_i in \mathbb{H}^3 (cf Lemma 4.3).

Corollary 5.4 *$\gamma(X_i) \cap \partial B_\infty$ is a strip between two parallel Euclidean lines in ∂B_∞ for every $\gamma \in \Gamma$ which sends a parabolic fixed point of Γ_i to ∞ . Moreover the center line of the strip $\gamma(X_i) \cap \partial B_\infty$ is parallel to the center line of the strip $X_i \cap \partial B_\infty$.*

In fact $\gamma(X_i) \cap \partial B_\infty$ is an ϵ -collared neighborhood of $\gamma(H_i) \cap \partial B_\infty$ in ∂B_∞ for every γ given in Corollary 5.4.

Note that X_i is a metrically complete and strictly convex 3-submanifold of \mathbb{H}^3 with C^1 boundary, invariant under the action of Γ_i . Let

$$\mathcal{B}_i = \{X_i \cap B; B \text{ a component of } \mathcal{B} \text{ based at a parabolic fixed point of } \Gamma_i\}.$$

We call \mathcal{B}_i the *horoball region* of X_i . Let $X_i^- = X_i \setminus \mathcal{B}_i$, and call $X_i^- \cap \partial \mathcal{B}_i$ the *parabolic boundary* of X_i^- , denoted by $\partial_p X_i^-$. Note that X_i^- is locally convex everywhere except on its parabolic boundary.

Each of X_i , \mathcal{B}_i , X_i^- and $\partial_p X_i^-$ is invariant under the action of Γ_i . Let $Y_i = X_i / \Gamma_i$, which is a metrically complete and strictly convex hyperbolic 3-manifold with boundary. Topologically $Y_i = S_i \times I$, where $I = [-1, 1]$. There is a local isometry f_i of Y_i into M , which is induced from the covering map $\mathbb{H}^3 / \Gamma_i \rightarrow M$ by restriction on Y_i , since $Y_i = X_i / \Gamma_i$ is a submanifold of \mathbb{H}^3 / Γ_i . Also $p|_{X_i} = f_i \circ p_i$, where p_i is the universal covering map $X_i \rightarrow Y_i = X_i / \Gamma_i$. Let $Y_i^- = X_i^- / \Gamma_i$, let $\mathcal{C}_i = \mathcal{B}_i / \Gamma_i$, and let $\partial_p Y_i^- = \partial_p X_i^- / \Gamma_i$. We call \mathcal{C}_i the cusp part of Y_i , and call $\partial_p Y_i^-$ the parabolic boundary of Y_i^- , which is the frontier of Y_i^- in Y_i and is also the frontier of \mathcal{C}_i in Y_i . The manifold Y_i^- is locally convex everywhere except on its parabolic boundary. Topologically $Y_i^- = S_i^- \times I$, where each component of $\partial_p Y_i^-$ is an annulus.

From now on we fix an I -bundle structure for $Y_i = S \times I$ as follows. We first fix an I -bundle structure on $Y_i^- = S_i^- \times I$ such that $\partial_p Y_i^- = \partial S_i^- \times I$. We may actually assume that $\partial S_i^- \times \{0\}$ are the center horo-circles of $\partial_p Y_i^-$ and that all the I -fibers in $\partial_p Y_i^-$ are perpendicular to $\partial S_i^- \times \{0\}$ with respect to the hyperbolic metric. Next we extend the I -bundle structure to the cusp part \mathcal{C}_i of Y_i in the most natural way, ie if $C_{i,j}$ is a component of \mathcal{C}_i and if we write $C_{i,j}$ as $A_{i,j} \times [0, \infty)$, where each $A_{i,j} \times \{*\}$ is a horo-annulus, then we require each $A_{i,j} \times \{*\}$ consists of I -fibers, and all the I -fibers in $A_{i,j} \times \{*\}$ to be Euclidean geodesics perpendicular to the center horo-circle of $A_{i,j} \times \{*\}$.

We let any (free) cover of Y_i have the induced I -bundle structure. In particular X_i has the induced I -bundle structure from that of Y_i , and this structure is preserved by the action of Γ_i ; ie every element of Γ_i sends an I -fiber of X_i to an I -fiber of X_i .

Lemma 5.5 *For each $i = 1, 2$, there is a upper bound for the lengths of the I -fibers of Y_i .*

Proof Certainly the lengths of the I -fibers of $Y_i^- = S_i^- \times I$ are bounded, since S_i^- is compact. So we only need to show that the lengths of the I -fibers are bounded in the cusp part \mathcal{C}_i of Y_i . In turn we just need to show that this is true for every component of \mathcal{C}_i . Let $C_{i,j}$ be a component of \mathcal{C}_i , and let $\tilde{C}_{i,j}$ be a component of $p_i^{-1}(C_{i,j})$. There is an element $\sigma_{i,j}$ of Γ such that $\sigma_{i,j}(\tilde{C}_{i,j}) = \sigma_{i,j}(X_i) \cap B_\infty$. So we only need to show that the lengths of the I -fibers are bounded in $\sigma_{i,j}(X_i) \cap B_\infty$. But $\sigma_{i,j}(X_i) \cap B_\infty$ is the ϵ -collared neighborhood of $\sigma_{i,j}(H_i) \cap B_\infty$ in B_∞ by Lemma 5.3. Also from Lemma 5.3, we see that $\sigma_{i,j}(H_i) \cap B_\infty$ has the natural I -bundle structure, which is the restriction of the I -bundle structure of $\sigma_{i,j}(X_i) \cap B_\infty$. Clearly all I -fibers of $\sigma_{i,j}(H_i) \cap \partial B_\infty$ have the same length and every other I -fiber of $\sigma_{i,j}(H_i) \cap B_\infty$ has shorter length. Similar conclusions hold for I -fibers of $\sigma_{i,j}(X_i) \cap B_\infty$. \square

Corollary 5.6 *For each $i = 1, 2$, there is a upper bound for the lengths of the I -fibers of X_i .*

The map $f_i: Y_i = S_i \times I \rightarrow M$ is a local isometry but is not an embedding in general. In particular the center surface $f_i|: S_i \times \{0\} \rightarrow M$ may not be an embedding, but it follows from Corollary 5.4 that the map is an embedding when restricted on each component of $(S_i \times \{0\}) \cap \mathcal{C}_i$. Hence we may slightly perturb, if necessary, the cusp part of the $S_i \times \{0\}$ in Y_i , keeping it totally geodesic and transverse to the I -fibers, so that the resulting surface, when restricted to its cusp part, will be an embedding under the map f_i . We still use S_i to denote this surface, and we still denote Y_i as $S_i \times I$ and Y_i^- as $S_i^- \times I$. We call S_i the (topological) center surface of Y_i . Note

that $f_i: S_i \rightarrow M$ is quasi-Fuchsian and each component of $p^{-1}(f_i(S_i))$ is contained in $\gamma(X_i)$ as a topological center surface for some $\gamma \in \Gamma$.

The restriction map $f_i: (Y_i^-, \partial_p Y_i^-) \rightarrow (M^-, \partial M^-)$ is a proper map of pairs and $f_i: (S_i^-, \partial S_i^-) \rightarrow (M^-, \partial M^-)$ is a proper map which is an embedding on ∂S_i^- (This property will remain valid if we shrink the cusp C of M geometrically). We fix an orientation for S_i , and let S_i^- and ∂S_i^- have the induced orientation. Let $\beta_{i,j}$, $j = 1, \dots, n_i$, denote the components of ∂S_i indexed so that their images $f_i(\beta_{i,j})$, $j = 1, \dots, n_i$, appear consecutively on ∂M^- . Let Δ be the geometric intersection number between $f_1(\beta_{1,1})$ and $f_2(\beta_{2,1})$. Since each $f_i(\beta_{i,j})$ is a Euclidean circle in the Euclidean torus ∂M^- , each pair of circles $f_1(\beta_{1,j})$ and $f_2(\beta_{2,k})$ have exactly Δ intersection points. Hence there are a total of $d = n_1 n_2 \Delta$ intersection points between $f_1(\partial S_1^-)$ and $f_2(\partial S_2^-)$ in the torus ∂M^- (all distinct in ∂M^-). Let t_1, \dots, t_d denote these intersection points. The points $f_i^{-1}\{t_1, \dots, t_d\}$ can be indexed as $\{t_{i,j,k}, j = 1, \dots, n_i, k = 1, \dots, d_i\}$, where $d_i = \Delta n_{i^*}$ and i^* is the number such that $\{i, i^*\} = \{1, 2\}$. We may further assume that $\{t_{i,j,k}, k = 1, \dots, d_i\}$ are contained successively in the component $\beta_{i,j}$, following the orientation of $\beta_{i,j}$, for each $j = 1, \dots, n_i$.

We remark that all the results and notations in this section will still be valid and consistent if we replace the cusp C by a smaller one.

6 The manifold K_i

We continue to use the notations established in [Section 5](#). The purpose of this section is to construct, for each of $i = 1, 2$, a manifold K_i , which, on an intuitive level, corresponds to the intersection of Y_1 and Y_2 in M , and which will be used to cut and paste two immersions.

For each of the points t_j , $j = 1, \dots, d$, which was defined at the end of [Section 5](#), there is a unique embedded geodesic ray R_j in C , based at t_j , perpendicular to ∂C . We shall associate to each R_j (thus to t_j), a metrically complete and convex hyperbolic manifold $K_{i,k}$ with a local isometry, $g_{i,k}$, into Y_i (for each of $i = 1, 2$) such that:

- (1) the truncated version of $K_{i,k}$, denoted $K_{i,k}^-$ (whose definition will be given below), is a compact 3-manifold;
- (2) there is an isometry $h_k: K_{1,k} \rightarrow K_{2,k}$ such that

$$h_k|: (K_{1,k}^-, \partial_p K_{1,k}^-) \rightarrow (K_{2,k}^-, \partial_p K_{2,k}^-)$$

is a proper isometry. (The definition of $\partial_p K_{i,k}^-$ will be given below.)

To do this, we first choose points b_j , $j = 1, \dots, d$, in ∂B_∞ such that $p(b_j) = t_j$. Recall that $p: \mathbb{H}^3 \rightarrow M$ and $p_i: X_i \rightarrow Y_i$ are fixed universal covering maps. Let $\tilde{S}_i = p_i^{-1}(S_i)$. Then \tilde{S}_i is the (topological) center surface of X_i . Since Γ acts transitively on the set $p^{-1}(t_j)$ for each fixed j , there is an element $\gamma_{i,j}$ of Γ such that $\gamma_{i,j}(\tilde{S}_i)$ contains the point b_j . Let $X_{i,j} = \gamma_{i,j}(X_i)$. Then $\gamma_{i,j}(\tilde{S}_i)$ is the center surface of $X_{i,j} = \gamma_{i,j}(X_i)$, and $X_{i,j}$ is invariant under the action of the subgroup $\gamma_{i,j}\Gamma_i\gamma_{i,j}^{-1}$. Let $W_j = X_{1,j} \cap X_{2,j}$. Then W_j is a metrically complete and strictly convex (thus simply connected) 3-dimensional submanifold of \mathbb{H}^3 which is invariant under the action of the subgroup $(\gamma_{1,j}\Gamma_1\gamma_{1,j}^{-1}) \cap (\gamma_{2,j}\Gamma_2\gamma_{2,j}^{-1})$. Let $Z_{i,j} = \gamma_{i,j}^{-1}(W_j)$. Then $Z_{1,j} = X_1 \cap \gamma_{1,j}^{-1}\gamma_{2,j}(X_2)$ is contained in X_1 and is invariant under the action of the subgroup $\Gamma_{i,j} = \Gamma_1 \cap (\gamma_{1,j}^{-1}\gamma_{2,j}\Gamma_2\gamma_{2,j}^{-1}\gamma_{1,j})$, and similarly $Z_{2,j} = X_2 \cap \gamma_{2,j}^{-1}\gamma_{1,j}(X_1)$ is contained in X_2 and is invariant under the action of the subgroup $\Gamma_{2,j} = \Gamma_2 \cap (\gamma_{2,j}^{-1}\gamma_{1,j}\Gamma_1\gamma_{1,j}^{-1}\gamma_{2,j})$.

Lemma 6.1 *The subgroup $\Gamma_{i,j}$ contains no parabolic elements, for any $i = 1, 2, j = 1, \dots, d$.*

Proof Recall that i and i_* denote the number 1 or 2 such that $\{i, i_*\} = \{1, 2\}$, and that $\Gamma_{i,j} = \Gamma_i \cap (\gamma_{i,j}^{-1}\gamma_{i_*,j}\Gamma_{i_*}\gamma_{i_*,j}^{-1}\gamma_{i,j})$. Also recall Γ_i , $i = 1, 2$, are the fundamental groups of two embedded, cusped, quasi-Fuchsian surfaces, with different boundary slopes. Thus no parabolic element in Γ_i is conjugate in Γ to any element in Γ_{i_*} (cf the proof of Cooper–Long [7, Lemma 2.1]). Hence the conclusion of the lemma follows. \square

Recall that \mathcal{B}_i is the horoball region of X_i , which is the intersection of X_i with the collection of horoballs in \mathcal{B} based at parabolic fixed points of Γ_i . Note that $\Lambda(X_i) = \Lambda(\Gamma_i)$. We claim that the limit set $\Lambda(Z_{i,j})$ of $Z_{i,j}$ is equal to the intersection $\Lambda(\Gamma_i) \cap \Lambda(\gamma_{i,j}^{-1}\gamma_{i_*,j}\Gamma_{i_*}\gamma_{i_*,j}^{-1}\gamma_{i,j})$. Indeed, the containment $\Lambda(Z_{i,j}) \subset \Lambda(\Gamma_i) \cap \Lambda(\gamma_{i,j}^{-1}\gamma_{i_*,j}\Gamma_{i_*}\gamma_{i_*,j}^{-1}\gamma_{i,j})$ is obvious. For the other containment, suppose that x is in $\Lambda(\Gamma_i) \cap \Lambda(\gamma_{i,j}^{-1}\gamma_{i_*,j}\Gamma_{i_*}\gamma_{i_*,j}^{-1}\gamma_{i,j})$. Then there are geodesic rays α and α' , contained in H_i and $\gamma_{i,j}^{-1}\gamma_{i_*,j}H_{i_*}$ respectively, with x as a limit endpoint. Then far enough along these geodesics, each point in α is within an epsilon-neighborhood of α' , and vice versa. Therefore, far enough along these geodesics, α and α' are both contained in $X_i \cap \gamma_{i,j}^{-1}\gamma_{i_*,j}X_{i_*}$, and therefore x is a limit point of $Z_{i,j}$.

Since quasi-Fuchsian groups are geometrically finite, we are able to apply Matsuzaki–Taniguchi [14, Theorem 3.14] (which is originally due to Susskind [18]) and to conclude that $\Lambda(\Gamma_i) \cap \Lambda(\gamma_{i,j}^{-1}\gamma_{i_*,j}\Gamma_{i_*}\gamma_{i_*,j}^{-1}\gamma_{i,j}) = \Lambda(\Gamma_{i,j}) \cup P_{i,j}$, where $P_{i,j}$ is the set of points $\zeta \in \Omega(\Gamma_{i,j}) = S_\infty^2 - \Lambda(\Gamma_{i,j})$ such that:

- (1) $\text{Stab}_{\Gamma_i}(\zeta)$ and $\text{Stab}_{\gamma_{i,j}^{-1}\gamma_{i^*,j}\Gamma_{i^*}\gamma_{i^*,j}^{-1}\gamma_{i,j}}(\zeta)$ generate a rank two Abelian group;
- (2) $\text{Stab}_{\Gamma_i}(\zeta) \cap \text{Stab}_{\gamma_{i,j}^{-1}\gamma_{i^*,j}\Gamma_{i^*}\gamma_{i^*,j}^{-1}\gamma_{i,j}}(\zeta) = \{\text{id}\}$.

Also, $\Lambda(\Gamma_{i,j}) = \Lambda_p(\Gamma_{i,j}) \cup \Lambda_c(\Gamma_{i,j})$, where Λ_c denotes the set of conical limit points and Λ_p the set of parabolic limit points (see Matsuzaki–Taniguchi [14] or Ratcliffe [17] for their definitions). By Lemma 6.1, $\Gamma_{i,j}$ contains no parabolic elements, and thus $\Lambda_p(\Gamma_{i,j}) = \emptyset$. Thus $\Lambda(\Gamma_i) \cap \Lambda(\gamma_{i,j}^{-1}\gamma_{i^*,j}\Gamma_{i^*}\gamma_{i^*,j}^{-1}\gamma_{i,j}) = \Lambda_c(\Gamma_{i,j}) \cup P_{i,j}$.

Let $\mathcal{B}_{i,j}$ be the intersection of $Z_{i,j}$ with the collection of horoballs in \mathcal{B} based at points of $P_{i,j}$. We call $\mathcal{B}_{i,j}$ the horoball region of $Z_{i,j}$. Let $Z_{i,j}^- = Z_{i,j} \setminus \mathcal{B}_{i,j}$, which is the truncated version of $Z_{i,j}$. We call $Z_{i,j}^- \cap \partial\mathcal{B}_{i,j}$ the parabolic boundary of $Z_{i,j}^-$ and denote it by $\partial_p Z_{i,j}^-$. Note that $Z_{i,j}^-$ is locally convex everywhere except on its parabolic boundary. Each of $Z_{i,j}$, $\mathcal{B}_{i,j}$, $Z_{i,j}^-$ and $\partial_p Z_{i,j}^-$ is invariant under the action of $\Gamma_{i,j}$.

Some members of $\{Z_{i,1}, \dots, Z_{i,d}\}$ maybe the same submanifold of X_i modulo the action of Γ_i on X_i , ie some one maybe a translation of another by an element of Γ_i .

Lemma 6.2 *The equality $Z_{1,j} = \gamma_1(Z_{1,k})$ holds for some $\gamma_1 \in \Gamma_1$ if and only if $Z_{2,j} = \gamma_2(Z_{2,k})$ for some $\gamma_2 \in \Gamma_2$.*

Proof Let $Z_{1,j} = \gamma_1(Z_{1,k})$ for some element $\gamma_1 \in \Gamma_1$ and suppose that $\gamma_2 = (\gamma_{2,j}^{-1}\gamma_{1,j})\gamma_1(\gamma_{1,k}^{-1}\gamma_{2,k})$. Then by our construction, γ_2 maps $Z_{2,k}$ to $Z_{2,j}$. Also, $Z_{2,k}$ contains a point in $p^{-1}(t_k) \cap \tilde{S}_2$, and γ_2 maps this to another point in $p^{-1}(t_k) \cap \tilde{S}_2$. Since the Γ -stabilizer of any point in $p^{-1}(t_k)$ is trivial and since Γ_2 acts transitively on the set $p^{-1}(t_k) \cap \tilde{S}_2$, the element γ_2 must belong to Γ_2 . \square

Let j_1, \dots, j_q be such that $\{Z_{i,j_1}, \dots, Z_{i,j_q}\}$ is a maximal set of representatives of $\{Z_{i,1}, \dots, Z_{i,d}\}$ which are mutually inequivalent under the action of Γ_i on X_i for each $i = 1, 2$. Note that the set $\{Z_{i,j_1}, \dots, Z_{i,j_q}\}$ is well defined (independent of the choices for the points $b_j \in p^{-1}(t_j) \cap \partial B_\infty$), up to translations by elements in Γ_i .

Lemma 6.3 *The subgroup Γ_{i,j_k} acts transitively on $p^{-1}(t_j) \cap Z_{i,j_k} \cap \tilde{S}_i$, for each fixed j, k, i .*

Proof We know that Γ_i acts transitively on $p^{-1}(t_j) \cap \tilde{S}_i$ and $\gamma_{i,j_k}^{-1}\gamma_{i^*,j_k}\Gamma_{i^*}\gamma_{i^*,j_k}^{-1}\gamma_{i,j_k}$ acts transitively on $p^{-1}(t_j) \cap \gamma_{i,j_k}^{-1}\gamma_{i^*,j_k}(\tilde{S}_{i^*})$, so given two distinct points \tilde{t} and \tilde{t}' in $p^{-1}(t_j) \cap Z_{i,j_k} \cap \tilde{S}_i$, there exists $\gamma \in \Gamma_i$, and $\gamma' \in \gamma_{i,j_k}^{-1}\gamma_{i^*,j_k}\Gamma_{i^*}\gamma_{i^*,j_k}^{-1}\gamma_{i,j_k}$ such that each of them maps \tilde{t} to \tilde{t}' . But there is a unique element of Γ which maps \tilde{t} to \tilde{t}' . Thus $\gamma = \gamma'$ and so $\gamma \in \Gamma_i \cap (\gamma_{i,j_k}^{-1}\gamma_{i^*,j_k}\Gamma_{i^*}\gamma_{i^*,j_k}^{-1}\gamma_{i,j_k}) = \Gamma_{i,j_k}$. \square

Each of the manifolds Z_{i,j_k} , Z_{i,j_k}^- , $\partial_p Z_{i,j_k}^-$ and \mathcal{B}_{i,j_k} is invariant under the action of the subgroup:

$$\Gamma_{i,j_k} = \Gamma_i \cap (\gamma_{i,j_k}^{-1} \gamma_{i^*,j_k} \Gamma_{i^*} \gamma_{i^*,j_k}^{-1} \gamma_{i,j_k})$$

Let $K_{i,k} = Z_{i,j_k} / \Gamma_{i,j_k}$, $K_{i,k}^- = Z_{i,j_k}^- / \Gamma_{i,j_k}$, $\partial_p K_{i,k} = \partial_p Z_{i,j_k}^- / \Gamma_{i,j_k}$, and $\mathcal{C}_{i,k} = \mathcal{B}_{i,j_k} / \Gamma_{i,j_k}$. For each $k = 1, \dots, q$, $K_{1,k}$ and $K_{2,k}$ are isometric, metrically complete, convex, hyperbolic manifolds. The isometry from $K_{1,k}$ to $K_{2,k}$ is the map h_k which makes the following diagram commute:

$$\begin{array}{ccc} Z_{1,j_k} & \xrightarrow{\gamma_{2,j_k}^{-1} \circ \gamma_{1,j_k}} & Z_{2,j_k} \\ \downarrow & & \downarrow \\ K_{1,k} & \xrightarrow{h_k} & K_{2,k} \end{array}$$

where the vertical maps are the covering maps. Also for each i and k , there is a local isometry $g_{i,k}$ from $K_{i,k}$ into Y_i which is the restriction of the covering map $X_i / \Gamma_{i,j_k} \rightarrow Y_i$. Let K_i be the disjoint union of $\{K_{i,k}, k = 1, \dots, q\}$. We have the isometry $h: K_1 \rightarrow K_2$ with $h|_{K_{1,k}} = h_k$. We also have the local isometry $g_i: K_i \rightarrow Y_i$ with $g_i|_{K_{i,k}} = g_{i,k}$.

Lemma 6.4 *The restriction of the covering map $Z_{i,j_k}^- \rightarrow K_{i,k}^-$ to every component of $\partial_p Z_{i,j_k}^-$ is an isometric embedding, for each of $i = 1, 2$ and each of $k = 1, \dots, q$. In fact the restriction of the covering map $Z_{i,j_k} \rightarrow K_{i,k}$ to every component of \mathcal{B}_{i,j_k} is an isometric embedding, for each of $i = 1, 2$ and each of $k = 1, \dots, q$.*

Proof It follows from [Corollary 5.4](#) and the transitivity of the action of Γ on the set $p^{-1}(t_j)$ (for any fixed j) that every component of $\partial_p Z_{i,j_k}^-$ is a Euclidean parallelogram in some horosphere. Now the first statement of the lemma follows from the fact that Γ_{i,j_k} has no parabolic elements ([Lemma 6.1](#)). The second assertion can be proved similarly. \square

We have just shown that each component \tilde{D} of $\partial_p Z_{i,j_k}^-$ (for any i, j_k) is a Euclidean parallelogram in a horosphere. We define the (topological) center point of \tilde{D} to be the point $\tilde{D} \cap \tilde{S}_i \cap \gamma_{i,j_k}^{-1} \gamma_{i^*,j_k} (\tilde{S}_{i^*})$. The union of all the center points in $\partial_p Z_{i,j_k}^-$ is invariant under the action of the subgroup Γ_{i,j_k} . By [Lemma 6.4](#), each component D of $\partial_p K_{i,k}$ is the isometric image of a component \tilde{D} of $\partial_p Z_{i,j_k}^-$ under the covering map $Z_{i,j_k} \rightarrow K_{i,k}$. We define the (topological) center point of D to be the image of the center point of \tilde{D} . Thus by our construction, for each $t_j \in f_1(\partial S_1^-) \cap f_2(\partial S_2^-)$, there is a component D of $\partial_p K_{i,k}^-$ (for some k) whose center point is mapped to the point t_j under the map $K_{i,k} \rightarrow Y_i \rightarrow M$. In fact there is a geodesic ray, based at the

center point, in the cusp part of $K_{i,k}$ which maps isometrically to the ray $R_j \subset C$, under the map $K_{i,k} \rightarrow Y_i \rightarrow M$. This component of $\partial_p K_{i,k}^-$ is said to be *associated to the ray R_j* (thus to the point t_j), and so is the component $K_{i,k}$ of K_i .

Lemma 6.5 *For each of $i = 1, 2$, the parabolic boundary of K_i^- has exactly d components (each being a Euclidean parallelogram), associated to the points t_j , $j = 1, \dots, d$, respectively.*

Proof We prove this for $i = 1$; the case for $i = 2$ can be proved similarly. By the construction, we see that the parabolic boundary of K_1^- has at least d components, associated to the points t_1, \dots, t_d respectively. Suppose that there are distinct components P_1 and P_2 of the parabolic boundary of K_1^- associated to the same point, say t_1 . Also we may assume that $K_{1,1}^-$ and $K_{1,k}^-$ are the components of K_1^- containing P_1 and P_2 respectively. We first show that $k = 1$ is impossible. So suppose that both P_1 and P_2 are components of $\partial_p K_{1,1}^-$. Recall that $K_{1,1}^- = Z_{1,j_1}^- / \Gamma_{1,j_1}$ and $\Gamma_{1,j_1} = \Gamma_1 \cap \gamma_{1,j_1}^{-1} \gamma_{2,j_1} \Gamma_2 \gamma_{2,j_1}^{-1} \gamma_{1,j_1}$. So the parabolic boundary of Z_{1,j_1}^- contains two components \tilde{P}_1 and \tilde{P}_2 which are mapped to P_1 and P_2 , respectively, under the covering map $Z_{1,j_1}^- \rightarrow K_{1,1}^-$. Because the center points of \tilde{P}_1 and \tilde{P}_2 are contained in $p^{-1}(t_1)$ and because Γ_{1,j_1} acts on $p^{-1}(t_1) \cap Z_{1,j_1}^- \cap \tilde{S}_1$ transitively (Lemma 6.3), there is an element $\gamma \in \Gamma_{1,j_1}$ such that $\gamma(\tilde{P}_1) = \tilde{P}_2$. Hence both \tilde{P}_1 and \tilde{P}_2 are mapped to P_1 under the covering map $Z_{1,j_1}^- \rightarrow K_{1,1}^-$, which gives a contradiction. Now suppose that $k \neq 1$. Then $Z_{1,j_1}^- = X_1^- \cap \gamma_{1,j_1}^{-1} \gamma_{2,j_1} (X_2^-)$ and $Z_{1,j_k}^- = X_1^- \cap \gamma_{1,j_k}^{-1} \gamma_{2,j_k} (X_2^-)$ are two different submanifolds of X_1^- , and there are two components \tilde{P}_1 and \tilde{P}_2 , belonging to $\partial_p Z_{1,j_1}^-$ and $\partial_p Z_{1,j_k}^-$ respectively, which are mapped to P_1 and P_2 under the covering maps $Z_{1,j_1}^- \rightarrow K_{1,1}^-$ and $Z_{1,j_k}^- \rightarrow K_{1,k}^-$ respectively. Since the center points of \tilde{P}_1 and \tilde{P}_2 are contained in $p^{-1}(t_1)$, and Γ_1 acts on $p^{-1}(t_1) \cap \tilde{S}_1$ transitively, there is an element $\gamma \in \Gamma_1$ which maps \tilde{P}_1 to \tilde{P}_2 . So $\gamma \gamma_{1,j_1}^{-1} \gamma_{2,j_1} (X_2)$ intersects X_1 at \tilde{P}_2 . So $(\gamma \gamma_{1,j_1}^{-1} \gamma_{2,j_1})^{-1}(\tilde{P}_2)$ and $(\gamma_{1,j_k}^{-1} \gamma_{2,j_k})^{-1}(\tilde{P}_2)$ are both contained in X_2 . It follows that $(\gamma \gamma_{1,j_1}^{-1} \gamma_{2,j_1})(\gamma_{1,j_k}^{-1} \gamma_{2,j_k})^{-1}$ is contained in Γ_2 . Therefore $(\gamma \gamma_{1,j_1}^{-1} \gamma_{2,j_1})(\gamma_{1,j_k}^{-1} \gamma_{2,j_k})^{-1}(X_2) = X_2$, ie $\gamma \gamma_{1,j_1}^{-1} \gamma_{2,j_1} (X_2) = \gamma_{1,j_k}^{-1} \gamma_{2,j_k} (X_2)$. Hence $\gamma(Z_{1,j_1}) = X_1 \cap \gamma \gamma_{1,j_1}^{-1} \gamma_{2,j_1} (X_2) = X_1 \cap \gamma_{1,j_k}^{-1} \gamma_{2,j_k} (X_2) = Z_{1,j_k}$. Hence Z_{1,j_1} and Z_{1,j_k} are equivalent under the translations of Γ_1 . This gives a contradiction to our assumption that these Z_{1,j_k} , $k = 1, \dots, q$, are mutually inequivalent under translations of elements of Γ_1 . \square

Lemma 6.6 $K_{i,k}^-$ is compact for each $i = 1, 2$, $k = 1, \dots, q$.

Proof Recall that $K_{i,k} = Z_{i,j_k} / (\Gamma_{i,j_k})$ and $\Gamma_{i,j_k} = \Gamma_i \cap (\gamma_{i,j_k}^{-1} \gamma_{i^*,j_k} \Gamma_{i^*} \gamma_{i^*,j_k}^{-1} \gamma_{i,j_k})$. The limit set of Z_{i,j_k} is equal to $\Lambda_c(\Gamma_{i,j_k}) \cup P_{i,j_k}$ (see the two paragraphs following the proof of Lemma 6.1).

Since $K_{i,k}$ is convex and metrically complete, between any two points in $K_{i,k}$ there is a distance minimizing geodesic connecting them. Fix a point k_0 in $K_{i,k}^-$. Consider $N_{(r,K_{i,k})}(k_0)$, the closed r -neighborhood of the point k_0 in $K_{i,j}$. Then by the Hopf–Rinow Theorem (Canary–Epstein–Green [5, Theorem 1.3.]) $N_{(r,K_{i,k})}(k_0)$ is a compact subset of $K_{i,k}$ for any $r > 0$.

As a subset of $K_{i,k}$, $K_{i,k}^-$ is closed. Hence $K_{i,k}^- \cap N_{(r,K_{i,k})}(k_0)$ is a closed subset of the compact set $N_{(r,K_{i,k})}(k_0)$ and thus is compact. Therefore if $K_{i,k}^-$ is not compact, then it is not contained in $N_{(r,K_{i,k})}(k_0)$ for any fixed $r > 0$. So we can find a point k_r in $K_{i,k}^-$ with $d(k_0, k_r) > r$ for any $r > 0$. By Lemma 6.5, the parabolic boundary of $K_{i,k}^-$ has finitely many components. Also each component of the parabolic boundary of $K_{i,k}^-$ is a compact Euclidean parallelogram. Hence for all sufficiently large $r > 0$, the parabolic boundary of $K_{i,k}^-$ is contained in $N_{(r,K_{i,k})}(k_0)$. Hence the points k_r are not in $\partial_p(K_{i,k}^-)$ for all sufficiently large $r > 0$. Let α_r be the distance minimizing geodesic segment in $K_{i,k}$ with endpoints k_0 and k_r .

Let $p_{i,k}: Z_{i,j_k} \rightarrow K_{i,k}$ be the covering map. Pick a point z_0 in Z_{i,j_k} such that $p_{i,k}(z_0) = k_0$. Let $\tilde{\alpha}_r \subset Z_{i,j_k}$ be the lift of α_r starting at z_0 (note that the lift is unique). Let z_r be the other endpoint of $\tilde{\alpha}_r$. Note that $\tilde{\alpha}_r$ is a distance minimizing geodesic segment in Z_{i,j_k} with $d(z_0, z) = d(p_{i,k}(z_0), p_{i,k}(z))$ for any $z \in \tilde{\alpha}_r$. Now consider the sequence of the geodesic segments $\{\tilde{\alpha}_n\}_{n=1}^\infty$. As $d(z_0, z_n) = d(k_0, k_n) \rightarrow +\infty$ as $n \rightarrow +\infty$, there is a subsequence of $\{z_n\}$ which converges to a point a in S_∞^2 . We may assume, for simplicity in notation, that $\{z_n\}$ itself converges to a . Now a is in the limit set of Z_{i,j_k} and thus $a \in \Lambda_c(\Gamma_{i,j_k}) \cup P_{i,j_k}$.

Let $\tilde{\alpha}$ be the geodesic ray in \mathbb{H}^3 starting at z_0 and approaching a (such a ray exists and is unique). Since Z_{i,j_k} is metrically complete and convex, $\tilde{\alpha}$ is contained in Z_{i,j_k} . In fact the sequence $\{\tilde{\alpha}_n\}$ is approaching $\tilde{\alpha}$ in the sense that every point x in $\tilde{\alpha}$ is the limit of a sequence of points $\{x_n\}$ with $x_n \in \tilde{\alpha}_n$. It follows that each finite sub-segment of the projection $p_{i,k}(\tilde{\alpha})$ is a distance-minimizing segment in $K_{i,k}$.

We first show that the point a is not in P_{i,j_k} . For otherwise if B_a is the horoball component in \mathcal{B} based at a , $\tilde{\alpha}$ intersects perpendicularly every horosphere inside B_a based at a . Hence $\tilde{\alpha} \cap B_a$ is a geodesic ray contained in $B_a \cap Z_{i,j_k}$. But $\tilde{\alpha}_n$ is approaching $\tilde{\alpha}$, so for sufficiently large n , z_n will enter into B_a . So z_n is not in Z_{i,j_k}^- and thus $p_{i,k}(z_n) = k_n$ is not contained in $K_{i,k}^-$, which contradicts our construction of k_n .

So a is a conical limit point of Γ_{i,j_k} . By definition there is a geodesic ray \tilde{l} ending at a and there is a sequence of elements σ_m in Γ_{i,j_k} such that $\sigma_m(z_0)$ is contained in $N_\epsilon(\tilde{l})$ (which is a fixed ϵ -collared neighborhood of \tilde{l} in \mathbb{H}^3) for all sufficiently large m , and converges to the point a as $m \rightarrow \infty$. Now the ray $\tilde{\alpha}$ is contained in $N_\epsilon(\tilde{l})$ except possibly for a finite initial segment. Let $\tilde{\alpha}_w$ be a sub-ray of $\tilde{\alpha}$ starting at a point $w \in \tilde{\alpha}$ such that $\tilde{\alpha}_w$ is entirely contained in $N_\epsilon(\tilde{l})$ and $d(z_0, w) > 2\epsilon$. For any point x on \tilde{l} let P_x be the hyperbolic plane intersecting \tilde{l} perpendicularly at the point x , and let $D_x = P_x \cap N_\epsilon(\tilde{l})$. Then D_x is topologically a disk separating $N_\epsilon(\tilde{l})$ into two pieces one of which contains the sub-ray of \tilde{l} starting at x . Now every point in the ray $\tilde{\alpha}_w$ is contained in D_x for some $x \in \tilde{l}$. In particular the endpoint w of $\tilde{\alpha}_w$ is contained in some D_x . Let V be the component of $N_\epsilon(\tilde{l}) - D_x$ which contains a sub-ray of \tilde{l} . Since the sequence $(\sigma_m(z_0))$ approaches a , there is some $\sigma_m(z_0)$ which is contained in V . Let $D_{x'}$ be the disk defined above containing $\sigma_m(z_0)$. Then $D_{x'}$ is contained in V and it also intersects a point w' in $\tilde{\alpha}_w$ (cf Figure 3). So $d(\sigma_m(z_0), w') \leq d(\sigma_m(z_0), x') + d(x', w') \leq \epsilon + \epsilon$. Hence $2\epsilon < d(z_0, w) \leq d(z_0, w') = d(p_{i,k}(z_0), p_{i,k}(w')) = d(p_{i,k}(\sigma_m(z_0)), p_{i,k}(w')) \leq d(\sigma_m(z_0), w') \leq 2\epsilon$ (here the first equality follows from the property that $\tilde{\alpha}$ is a distance minimizing curve), giving a contradiction. \square

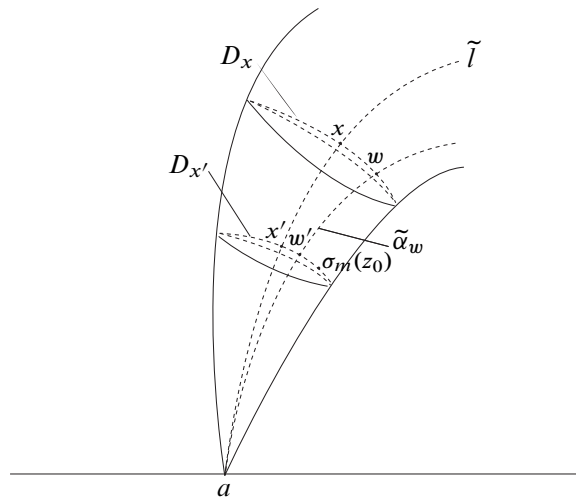

Figure 3

Let R be a fixed number bigger than the number $R(\epsilon)$ provided in Proposition 4.5 and also bigger than the upper bound provided by Corollary 5.6 for the lengths of I -fibers of X_i (for each of $i = 1, 2$). Consider $N_{(R, X_i)}(Z_{i,j_k})$, the R -collared neighborhood

of Z_{i,j_k} in X_i . It is a convex 3–submanifold in $X_i \subset \mathbb{H}^3$ (thus is simply connected) and is invariant under the action of Γ_{i,j_k} . We let $AN_{(R,X_i)}(K_{i,k})$ denote the quotient space $N_{(R,X_i)}(Z_{i,j_k}) / \Gamma_{i,j_k}$, and call it the *abstract R –collared neighborhood of $K_{i,k}$ with respect to X_i* . Similarly we can define the truncated version of $N_{(R,X_i)}(Z_{i,j_k})$ and the truncated version of $AN_{(R,X_i)}(K_{i,k})$, denoted by $(N_{(R,X_i)}(Z_{i,j_k}))^-$ and $(AN_{(R,X_i)}(K_{i,k}))^-$ respectively. It follows from Lemma 6.6 that $(AN_{(R,X_i)}(K_{i,k}))^-$ is compact. We can extend $g_{i,k}: K_{i,k} \rightarrow Y_i$ to a map, which we still denote $g_{i,k}$, from $AN_{(R,X_i)}(K_{i,k})$ to Y_i .

By construction, $N_{(R,X_i)}(Z_{i,j_k})$ contains all the I –fibers of X_i which meet Z_{i,j_k} . Let Z'_{i,j_k} be the sub- I –bundle of X_i consisting of all the I –fibers of X_i which meet Z_{i,j_k} . It is easy to see that Z'_{i,j_k} is a manifold. The manifold Z'_{i,j_k} is also invariant under the action of Γ_{i,j_k} since Z_{i,j_k} is invariant under the action of Γ_{i,j_k} and since the action of $\Gamma_{i,j_k} \subset \Gamma_i$ on X_i sends fibers to fibers. Hence $Z'_{i,j_k} / \Gamma_{i,j_k} = F_{i,k} \times I$ for some surface $F_{i,k}$ (which is non-compact), with the induced I –fiber structure. From the inclusions $K_{i,k} \subset F_{i,k} \times I \subset AN_{(R,X_i)}(K_{i,k})$ and from the fact that the inclusion map $K_{i,k} \subset AN_{(R,X_i)}(K_{i,k})$ induces an isomorphism on the fundamental groups, we see that the inclusion map $F_{i,k} \times I \subset AN_{(R,X_i)}(K_{i,k})$ induces a surjective homomorphism on the fundamental groups.

Note that $\partial F_{i,k} \times I$ is precisely the frontier of $F_{i,k} \times I$ in $AN_{(R,X_i)}(K_{i,k})$. Each component of $\partial F_{i,k} \times I$ is either an annulus or a strip, where a strip means $\mathbb{R} \times I$.

Lemma 6.7 *Let A be an annulus component of $\partial F_{i,k} \times I$. Then:*

- (1) A divides $AN_{(R,X_i)}(K_{i,k})$ into two components B_1 and B_2 .
- (2) Suppose B_1 is the component whose interior is disjoint from $F_{i,k} \times I$. Then either $B_1 = D \times I$, where D is a disk, such that $A = \partial D \times I$; or $B_1 = S^1 \times D$, where D is a disk, such that $A = I \times S^1$, where I is an interval contained in ∂D .

Proof Since $F_{i,k} \times I$ is a submanifold of $AN_{(R,X_i)}(K_{i,k})$ and carries the fundamental group of $AN_{(R,X_i)}(K_{i,k})$, it follows that A is separating in $AN_{(R,X_i)}(K_{i,k})$, ie we have (1). Part (2) also follows easily. \square

Similarly we have:

Lemma 6.8 *Let E be a strip component of $\partial F_{i,k} \times I$. Then:*

- (1) E divides $AN_{(R,X_i)}(K_{i,k})$ into two components B_1 and B_2 .
- (2) Suppose B_1 is the component whose interior is disjoint from $F_{i,k} \times I$. Then $B_1 = \mathbb{R} \times D$, where D is a disk, such that $E = \mathbb{R} \times I$, where I is an interval contained in ∂D .

It follows from Lemmas 6.7 and 6.8 that the I bundle structure of $F_{i,k} \times I$ can be extended to one on $AN_{(R,X_i)}(K_{i,k})$ in an obvious way.

Similarly one can obtain corresponding results in the truncated setting. Namely $(AN_{(R,X_i)}(K_{i,k}))^-$ has a sub-manifold of the form $F_{i,k}^- \times I$ which carries the fundamental group of $(AN_{(R,X_i)}(K_{i,k}))^-$, and the I -bundle structure of $F_{i,k}^- \times I$ can be extended to one on $(AN_{(R,X_i)}(K_{i,k}))^-$ in an obvious way, such that the parabolic boundary of $(AN_{(R,X_i)}(K_{i,k}))^-$ consists of I -fibers. Note that the I -fiber structure may not agree with the original I -fiber structure on $X_i/\Gamma_{i,j}$.

Since $(AN_{(R,X_i)}(K_{i,k}))^-$ is compact for each $i = 1, 2$, $k = 1, \dots, q$, and since the horoball region of $AN_{(R,X_i)}(K_{i,k})$ has a standard shape, we may assume, up to replacing the cusp C of M by a smaller one, that $g_{i,k}^{-1}(C_i) \cap (AN_{(R,X_i)}(K_{i,k}))^- = \partial_p(AN_{(R,X_i)}(K_{i,k}))^-$ (where C_i is the cusp part of Y_i) for each of $i = 1, 2$, $k = 1, \dots, q$.

We let $AN_{(R,X_i)}(K_i)$ denote the disjoint union of $\{AN_{(R,X_i)}(K_{i,k}); k = 1, \dots, q\}$, and let $g_i: AN_{(R,X_i)}(K_i) \rightarrow Y_i$, extending the local isometries $g_{i,k}$. For later use, we record the following corollary.

Corollary 6.9 *Suppose that the local isometry*

$$g_i: (AN_{(R,X_i)}(K_i))^- = \amalg_k (AN_{(R,X_i)}(K_{i,k}))^- \rightarrow Y_i^-$$

lifts to an embedding in a finite cover \check{Y}_i^- of Y_i^- . Then the I -bundle structure on \check{Y}_i^- can be adjusted to one so that the image of $(AN_{(R,X_i)}(K_i))^-$ is a sub- I -bundle in \check{Y}_i^- .

Let $Fr_{X_i}(N_{(R,X_i)}(Z_{i,j_k}))$ denote the frontier of $N_{(R,X_i)}(Z_{i,j_k})$ in X_i . If we define the frontier boundary $\partial_f(AN_{(R,X_i)}(K_{i,k}))$ of $AN_{(R,X_i)}(K_{i,k})$ to be

$$Fr_{X_i}(N_{(R,X_i)}(Z_{i,j_k}))/\Gamma_{i,j_k}$$

then $\partial_f(AN_{(R,X_i)}(K_{i,k}))$ is topologically parallel to $\partial F_{i,k} \times I$ by Lemmas 6.7 and 6.8. Thus each component of $\partial_f(AN_{(R,X_i)}(K_{i,k}))$ is either an annulus or a strip. A strip component must enter the cusp region of $AN_{(R,X_i)}(K_{i,k})$. From the shape of the cusp region of $AN_{(R,X_i)}(K_{i,k})$ and from Lemma 6.5, we see that the frontier boundary of $AN_{(R,X_i)}(K_i)$ has exactly d strip components and that the frontier boundary of each component $AN_{(R,X_i)}(K_{i,k})$ of $AN_{(R,X_i)}(K_i)$ has at least two strip components. We restate this fact in the following corollary for later use.

Corollary 6.10

- (1) $\partial_f(AN_{(R,X_i)}(K_{i,k}))$ has at least two strip components for each $i = 1, 2$ and $k = 1, \dots, q$.
- (2) $\partial_f(AN_{(R,X_i)}(K_i))$ has exactly d strip components for each $i = 1, 2$.

The following corollary follows easily from the convexity of $N_{(R,X_i)}(Z_{i,j_k})$ and from the shape of the parabolic region of $N_{(R,X_i)}(Z_{i,j_k})$.

Corollary 6.11 Every component of $Fr_{X_i}(N_{(R,X_i)}(Z_{i,j_k}))$ has its two ends contained in two different horoball components of \mathcal{B} respectively.

We conclude with some remarks.

Remark 6.12 Results and notations in this section will still be valid if we replace the cusp C by a smaller one.

Remark 6.13 In the construction of $K_{i,k}$ and its local isometry $g_{i,k}$ into Y_i some choices were made (for instance the universal cover Z_{i,j_k} in X_i which is defined up to translation by elements of Γ_i). But, up to isometry, the construction is independent of all such choices; ie if $g'_{i,k}: K'_{i,k} \rightarrow Y_i$ is another result of this construction, then there is an isometry $\phi_{i,k}: K_{i,k} \rightarrow K'_{i,k}$ such that $g_{i,k} = g'_{i,k} \circ \phi_{i,k}$.

7 Constructing J_i

In Section 6, we constructed, for each $i = 1, 2$, the manifold $AN_{(R,X_i)}(K_i)$, which is the disjoint union of $\{AN_{(R,X_i)}(K_{i,k}); k = 1, \dots, q\}$, such that each component of $AN_{(R,X_i)}(K_i)$ is a metrically complete, convex, hyperbolic 3-manifold, and we defined a local isometry $g_i: AN_{(R,X_i)}(K_i) \rightarrow Y_i$. In this section we construct, for each $i = 1, 2$, a *connected*, metrically complete, convex, hyperbolic 3-manifold J_i with a local isometry $g_i: J_i \rightarrow Y_i$, such that J_i contains $AN_{(R,X_i)}(K_i)$ as a hyperbolic submanifold, and $J_i \setminus AN_{(R,X_i)}(K_i)$ is a compact 3-manifold W_i (which may not be connected). Obviously we may assume that $q > 1$, since otherwise we may simply take $J_i = AN_{(R,X_i)}(K_{i,1})$.

We continue to use the notations established in early sections. We have showed (Corollary 6.10) that $\partial_f(AN_{(R,X_i)}(K_{i,k}))$ has at least two strip components for each $k = 1, \dots, q$ and that $\partial_f(AN_{(R,X_i)}(K_i))$ has exactly d strip components. Let $E_{i,k}$ be a fixed strip component of $\partial_f AN_{(R,X_i)}(K_{i,k})$ for each fixed i and k . Recall $p_{i,k}: N_{(R,X_i)}(Z_{i,j_k}) \rightarrow AN_{(R,X_i)}(K_{i,k})$ is the universal covering map. Then each

component of $p_{i,k}^{-1}(E_{i,k}) \subset Fr_{X_i}(N_{(R,X_i)}(Z_{i,j_k}))$ is a strip isometric to $E_{i,k}$ under the map $p_{i,k}$. Let $\tilde{E}_{i,k}$ be a fixed component of $p_{i,k}^{-1}(E_{i,k})$.

The required J_i will be constructed by gluing components of $AN_{(R,X_i)}(K_i)$ with a compact 3-manifold W_i , along an attaching region in $\Pi E_{i,k}$. We shall construct the connecting manifold W_i in X_i . The procedure is as follows: find a suitable translation of $N_{(R,X_i)}(Z_{i,j_k})$ by an element $\tau_{i,k}$ of Γ_i , then take the convex hull of $\{\tau_{i,k}(N_{(R,X_i)}(Z_{i,j_k})); k = 1, \dots, q\}$ in X_i . The added part in forming the convex hull is the manifold W_i , which will be shown to be compact, and the attaching region of W_i with $\tau_{i,k}(N_{(R,X_i)}(Z_{i,j_k}))$ is contained in $\tau_{i,k}(\tilde{E}_{i,k})$.

If such W_i can be found, we can glue it with each $AN_{(R,X_i)}(K_{i,k})$ along $E_{i,k}$ using the isometry $\tau_{i,k}(\tilde{E}_{i,k}) \xrightarrow{\tau_{i,k}^{-1}} \tilde{E}_{i,k} \xrightarrow{p_{i,k}} E_{i,k}$. The resulting manifold J_i is a convex hyperbolic 3-manifold, with a local isometry into Y_i , extending the map $g_i: AN_{(R,X_i)}(K_i) \rightarrow Y_i$. It is easy to see that the hyperbolic structure in $AN_{(R,X_i)}(K_i)$ and the hyperbolic structure on W_i match up along their gluing surfaces, forming a global hyperbolic structure for J_i .

We now give the construction of W_i , beginning with some well known facts. Let γ be any hyperbolic element of $PSL_2(\mathbb{C})$. The axis of γ is denoted A_γ . Let a, a' be the two limit points of A_γ , which are the two fixed points of γ in S_∞^2 . Then for any point x in \mathbb{H}^3 , the sequence $\gamma^n(x)$ approaches one of the points a, a' , say a , as $n \rightarrow \infty$, and approaches a' , as $n \rightarrow -\infty$. Thus for any fixed closed subset W of \mathbb{H}^3 which is disjoint from a' , and for any fixed open neighborhood U of a in \mathbb{H}^3 there is an integer n such that $\gamma^n(W) \subset U$.

Lemma 7.1 *For any open arc α in $\Lambda_i = \Lambda(\Gamma_i)$, there exists a hyperbolic element γ of Γ_i such that the two limit points of A_γ are contained in α .*

Proof Since fixed points of hyperbolic elements of Γ_i are dense in Λ_i , there is a hyperbolic element δ in Γ_i with at least one of its two fixed points contained in α . Now take a hyperbolic element η of Γ_i such that the limit points of A_η are disjoint from the limit points of A_δ . By the notes given preceding the lemma, there is an integer n such that the two limit points of $\delta^n(A_\eta)$ are both contained in α . Let $\gamma = \delta^n \eta \delta^{-n}$, then $A_\gamma = \delta^n(A_\eta)$. \square

Each strip $\tilde{E}_{i,k}$ (defined earlier in this section) has exactly two limit points in Λ_i and each of them is a parabolic fixed point of Γ_i (the two parabolic fixed points are distinct because of the convexity of $N_{(R,X_i)}(Z_{i,j_k})$). Note that $\tilde{E}_{i,k}$ separates X_i into two

parts, one of which contains $N_{(R, X_i)}(Z_{i, j_k})$. Let $U_{i, k}$ be the part whose interior is disjoint from $N_{(R, X_i)}(Z_{i, j_k})$. Let $\alpha_{i, k}$ be the limit set of $U_{i, k}$.

Lemma 7.2 *After translations by suitable elements of Γ_i , we may assume that $N_{(R, X_i)}(Z_{i, j_2})$ is contained in the interior of $U_{i, 1}$ and that $N_{(R, X_i)}(Z_{i, j_1})$ is contained in the interior of $U_{i, 2}$*

Proof Let \bar{X}_i denote the closure of X_i in $\bar{\mathbb{H}}^3$. Note that $N_{(R, X_i)}(Z_{i, j_k})$ has the same limit set as Z_{i, j_k} . Let γ be a hyperbolic element of Γ_i whose axis has a limit point, a , disjoint from the limit points of $N_{(R, X_i)}(Z_{i, j_2})$. Then by the notes given in the paragraph proceeding [Lemma 7.1](#), we may move $N_{(R, X_i)}(Z_{i, j_2})$ by a power of γ into a small open neighborhood of a' (which is the other limit point of A_γ) in \bar{X}_i . In particular, we may assume that the limit set of this translate does not contain the limit set of $U_{i, 1}$. Then, applying [Lemma 7.1](#), there is an element in Γ_i which translates $N_{(R, X_i)}(Z_{i, j_2})$ into $U_{i, 1}$.

Thus we may assume that $N_{(R, X_i)}(Z_{i, j_2})$ is contained in the interior of $U_{i, 1}$. If $N_{(R, X_i)}(Z_{i, j_1})$ is contained in the interior of $U_{i, 2}$ already, then we are done. So suppose not. Then $U_{i, 2}$ is contained in the interior of $U_{i, 1}$. Let γ be a hyperbolic element of Γ_i such that the two limit points of A_γ are contained in the interior of the arc $\alpha_{i, 2}$; such an element exists by [Lemma 7.1](#). Then, after replacing $N_{(R, X_i)}(Z_{i, j_2})$ by its translate under a suitably high power of γ , one may check that the conclusion of the lemma is satisfied. \square

By [Lemma 7.2](#), $\tilde{E}_{i, 1}$ and $\tilde{E}_{i, 2}$ co-bound a connected submanifold of X_i , V_1 , whose interior is disjoint from both $N_{(R, X_i)}(Z_{i, j_1})$ and $N_{(R, X_i)}(Z_{i, j_2})$. The limit set of V_1 consists of two disjoint arcs in Λ_i . Now if $q > 2$, then by a method similar to the proof of [Lemma 7.2](#), we may assume, up to translation by a hyperbolic element of Γ_i , that $N_{(R, X_i)}(Z_{i, j_3})$ is in the interior of V_1 , and that both $N_{(R, X_i)}(Z_{i, j_1})$ and $N_{(R, X_i)}(Z_{i, j_2})$ are contained in the interior of $U_{i, 3}$. In other words, the three strips $\tilde{E}_{i, 1}$, $\tilde{E}_{i, 2}$ and $\tilde{E}_{i, 3}$ co-bound a connected submanifold V_2 in X_i such that the interior of V_2 is disjoint from $N_{(R, X_i)}(Z_{i, j_1})$, $N_{(R, X_i)}(Z_{i, j_2})$ and $N_{(R, X_i)}(Z_{i, j_3})$.

By a simple induction, we may assume that $N_{(R, X_i)}(Z_{i, j_k})$, $k = 1, \dots, q$, are located in X_i in such way that the q strips $\tilde{E}_{i, k}$, $k = 1, \dots, q$, co-bound a connected submanifold V of X_i whose interior is disjoint from $N_{(R, X_i)}(Z_{i, j_k})$, $k = 1, \dots, q$. Now we take the convex hull of the set $\{N_{(R, X_i)}(Z_{i, j_k}), k = 1, \dots, q\}$ in X_i , and let Z_i be the resulting convex manifold. Let W_i be the complement of the interior of $N_{(R, X_i)}(Z_{i, j_k})$, $k = 1, \dots, q$, in Z_i . Then, by [Proposition 4.6](#), W_i is a compact submanifold of X_i . This

W_i is the desired connecting manifold. The attaching region in ∂W , to be glued to $E_{i,k}$, is $W_i \cap \tilde{E}_{i,k}$.

We still use g_i to denote the local isometry $J_i \rightarrow Y_i$. Since W_i is compact, there exists a cusp C' of M , smaller than or equal to C , such that $g_i(W_i)$ is disjoint from the corresponding cusp region C'_i of Y_i . We may assume that the cusp C itself already satisfies this condition. Under this assumption, W_i is disjoint from $AN_{(R,X_i)}(K_i) \setminus (AN_{(R,X_i)}(K_i))^-$, and the components of $(AN_{(R,X_i)}(K_i))^-$ are connected together by W_i along the frontier boundary of $AN_{(R,X_i)}(K_i)$, forming a connected compact manifold which we denote by J_i^- . The parabolic boundary $\partial_p J_i^-$ is defined to be the parabolic boundary of $(AN_{(R,X_i)}(K_i))^-$. Then $g_i: (J_i^-, \partial_p J_i^-) \rightarrow (Y_i^-, \partial_p Y_i^-)$ is a proper map of pairs.

Each component of $\partial_p J_i^-$ can be isometrically embedded in ∂B_∞ as a Euclidean parallelogram. The convex hull of such a parallelogram is a convex 3–ball in B_∞ lying vertically above the parallelogram. We let \hat{J}_i denote the manifold obtained by capping off each of its parabolic boundary component by a convex 3–ball as just described. Then \hat{J}_i is a connected, compact, convex 3–manifold with a local isometry (which we still denote by g_i) into Y_i .

8 Constructing $C_n(J_i^-)$

From Sections 5, 6 and 7, we have the following setting: for each $i = 1, 2$, $f_i: Y_i = S_i \times I \rightarrow M$ is a local isometry; $f_i|: (Y_i^- = S_i^- \times I, \partial_p Y_i^- = \partial S_i^- \times I) \rightarrow (M, \partial M)$ is a proper map; $f_i|: \partial S_i^- \rightarrow \partial M$ is an embedding; ∂S_i^- has n_i components $\{\beta_{i,j}, j = 1, \dots, n_i\}$ with induced orientation; Δ is the geometric intersection number between $f_1(\beta_{1,1})$ and $f_2(\beta_{2,1})$; there are $d = \Delta n_1 n_2$ intersection points $\{t_1, \dots, t_d\}$ between $f_1(\partial S_1^-)$ and $f_2(\partial S_2^-)$ in ∂M ; $\{t_{i,j,k}, j = 1, \dots, n_i, k = 1, \dots, d_i\}$ are the points in $f_i^{-1}\{t_1, \dots, t_d\}$, where $d_i = \Delta n_{i^*}$, indexed so that $\{t_{i,j,k}, k = 1, \dots, d_i\}$ are contained successively in the component $\beta_{i,j}$ (following the orientation of $\beta_{i,j}$) for each $j = 1, \dots, n_i$; K_i is the disjoint union of the “intersection manifolds” $\{K_{i,j}, j = 1, \dots, q\}$; the manifold $AN_{(R,X_i)}(K_i) = \Pi AN_{(R,X_i)}(K_{i,k})$ is the abstract R –collared neighborhood of K_i with respect to X_i ; each component $AN_{(R,X_i)}(K_{i,k})$ is a metrically complete, convex, hyperbolic 3–manifold with a local isometry $g_{i,k}: AN_{(R,X_i)}(K_{i,k}) \rightarrow Y_i$; the restriction $g_{i,k}|: ((AN_{(R,X_i)}(K_{i,k}))^-, \partial_p(AN_{(R,X_i)}(K_{i,k}))^-) \rightarrow (Y_i^-, \partial_p Y_i^-)$ is a proper map; $g_i: AN_{(R,X_i)}(K_i) \rightarrow Y_i$ is the local isometry with $g_i|_{AN_{(R,X_i)}(K_{i,k})} = g_{i,k}$; J_i is a metrically complete convex (thus connected) hyperbolic 3–manifold with local isometry $g_i: J_i \rightarrow Y_i$; $g_i|: (J_i^-, \partial_p J_i^-) \rightarrow (Y_i^-, \partial_p Y_i^-)$ is a proper map; J_i contains $AN_{(R,X_i)}(K_i)$ as a submanifold; and $\partial_p J_i^- = \partial_p(AN_{(R,X_i)}(K_i))^-$.

Also recall that there are exactly d components in $\partial_p J_i^- = \partial_p(AN_{(R, X_i)}(K_i))^-$, one each associated to the points t_1, \dots, t_d respectively. Let $D_{i,j,k}$, $j = 1, \dots, n_i, k = 1, \dots, d_i$ denote the components of $\partial_p J_i^-$ and let $b_{i,j,k}$ be the topological center point of $D_{i,j,k}$, indexed so that $g_i(b_{i,j,k}) = t_{i,j,k}$.

The purpose of this section is to construct, for each sufficiently large integer n , a connected, compact, convex, hyperbolic 3-manifold $C_n(J_i^-)$, with a local isometry into Y_i , such that $C_n(J_i^-)$ contains J_i^- as a hyperbolic submanifold. $C_n(J_i^-)$ is obtained by gluing together J_i^- with n_i “multi- I -handles” $H_{i,j}^n$, $j = 1, \dots, n_i$, along the attaching region $\partial_p J_i^-$ (see Figure 4 for a preview). A more precise description of $C_n(J_i^-)$ will be clear after its construction. The needed properties of $C_n(J_i^-)$ will be described in later sections.

Now we proceed to construct the multi- I -handle $H_{i,j}^n$ for each fixed $i \in \{1, 2\}$ and each fixed $j \in \{1, \dots, n_i\}$. Let $c_{i,j}$ be a fixed component of $p^{-1}(f_i(\beta_{i,j}))$ in the horizontal horosphere ∂B_∞ . The transitivity of the action of Γ implies that there is element $\delta_{i,j} \in \Gamma$ such that $\delta_{i,j}(\tilde{S}_i)$ contains $c_{i,j}$. By Corollary 5.4, $\delta_{i,j}(X_i) \cap \partial B_\infty$ is a strip in ∂B_∞ between two parallel Euclidean lines, which contains $c_{i,j}$ as its (topological) center line. Let $E_{i,j}$ denote this strip.

Along $c_{i,j}$, we index the set of points $p^{-1}(\{f_i(t_{i,j,k}), k = 1, \dots, d_i\})$ as $a_{i,j,k,m}$, $k = 1, \dots, d_i, m \in \mathbb{Z}$, such that:

- (1) for each fixed m , the points $\{a_{i,j,k,m}, k = 1, \dots, d_i\}$ appear consecutively along the line $c_{i,j}$ following the orientation of $c_{i,j}$ (which is induced from that of $\beta_{i,j}$);
- (2) the point $a_{i,j,d_i,m}$ is followed immediately by the point $a_{i,j,1,m+1}$, for every m ;
- (3) $p(a_{i,j,k,m}) = f_i(t_{i,j,k})$, for all $k = 1, \dots, d_i$ and $m \in \mathbb{Z}$.

For an arbitrary (fixed) sufficiently large integer $n > 0$, consider the following d_i points on $c_{i,j}$: $a_{i,j,1,0}, a_{i,j,2,n}, a_{i,j,3,2n}, \dots, a_{i,j,d_i,(d_i-1)n}$.

Again by transitivity of the action of Γ , there are elements $\gamma_{i,j,1}, \gamma_{i,j,2}, \dots, \gamma_{i,j,d_i} \in \Gamma$ such that $\gamma_{i,j,1}(\tilde{S}_{i*}), \gamma_{i,j,2}(\tilde{S}_{i*}), \dots, \gamma_{i,j,d_i}(\tilde{S}_{i*})$ contain the points $a_{i,j,1,0}, a_{i,j,2,n}, \dots, a_{i,j,d_i,(d_i-1)n}$ respectively. Consider the corresponding translations of:

$$X_{i*} : \gamma_{i,j,1}(X_{i*}), \gamma_{i,j,2}(X_{i*}), \dots, \gamma_{i,j,d_i}(X_{i*})$$

Each of $\delta_{i,j}(X_i) \cap \gamma_{i,j,1}(X_{i*}), \delta_{i,j}(X_i) \cap \gamma_{i,j,2}(X_{i*}), \dots, \delta_{i,j}(X_i) \cap \gamma_{i,j,d_i}(X_{i*})$ is a translation of some component in $\{Z_{i,j_1}, \dots, Z_{i,j_q}\}$.

Let Z_1, \dots, Z_{d_i} denote $\delta_{i,j}(X_i) \cap \gamma_{i,j,1}(X_{i*}), \dots, \delta_{i,j}(X_i) \cap \gamma_{i,j,d_i}(X_{i*})$ respectively, and let $N_R(Z_i) = N_{(R, \delta_{i,j}(X_i))}(Z_i)$. Each of $N_R(Z_1), \dots, N_R(Z_{d_i})$ is a translation of some component in $\{N_{(R, X_i)}(Z_{i,j_1}), \dots, N_{(R, X_i)}(Z_{i,j_q})\}$.

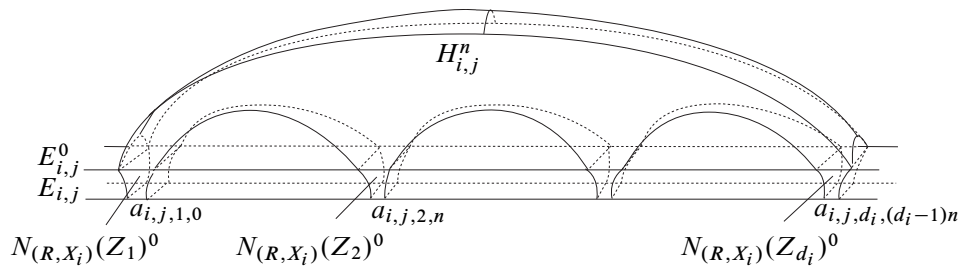

Figure 4

Let B_∞^0 be a fixed horoball based at ∞ which is a little smaller than B_∞ , ie its boundary ∂B_∞^0 is a little higher than ∂B_∞ . Let $E_{i,j}^0 = \delta_{i,j}(X_i) \cap \partial B_\infty^0$, and let $N_R(Z_1)^0, \dots, N_R(Z_{d_i})^0$ be the part of $N_R(Z_1), \dots, N_R(Z_{d_i})$ between the two horizontal planes ∂B_∞^0 and ∂B_∞ .

Then $N_R(Z_1)^0 \cap \partial B_\infty, N_R(Z_2)^0 \cap \partial B_\infty, \dots, N_R(Z_{d_i})^0 \cap \partial B_\infty$ are Euclidean parallelograms contained in $E_{i,j}$, containing the points $a_{i,j,1,0}, a_{i,j,2,n}, \dots, a_{i,j,d_i,(d_i-1)n}$ as their topological center points, respectively, and they are isometric to $D_{i,j,k}, k = 1, 2 \dots, d_i$, respectively.

As n is sufficiently large, $N_R(Z_1)^0, \dots, N_R(Z_{d_i})^0$ are mutually far apart from each other. We now take the convex hull of the set $\{N_R(Z_1)^0, \dots, N_R(Z_{d_i})^0\}$ in \mathbb{H}^3 and let $H_{i,j}^n$ be the resulting convex manifold. Obviously $H_{i,j}^n$ is contained in $\delta_{i,j}(X_i) \cap B_\infty$.

Let $U_{i,j}$ be the part of $\delta_{i,j}(X_i)$ between $E_{i,j}^0$ and $E_{i,j}$.

Then $N_R(Z_1)^0, \dots, N_R(Z_{d_i})^0$ are all contained in $U_{i,j}$, far apart from each other. We now show:

Lemma 8.1 *If n is sufficiently large, then:*

$$H_{i,j}^n \cap U_{i,j} = \{N_R(Z_1)^0, \dots, N_R(Z_{d_i})^0\}$$

Proof Let F_k be the frontier of $N_R(Z_k)^0$ in $U_{i,j}$, $1 \leq k \leq d_i$. Then F_k is contained in $\partial(N_R(\gamma_{i,j,k}(X_{i_*})))$. Since $N_R(\gamma_{i,j,k}(X_{i_*}))$ is strictly convex and since $\partial N_R(\gamma_{i,j,k}(X_{i_*}))$ is smooth, then for any point $x \in F_k$, there is a unique geodesic plane P_x in \mathbb{H}^3 such that $P_x \cap N_R(\gamma_{i,j,k}(X_{i_*})) = x$. Obviously P_x is not a vertical plane. Thus $P_x \cap \partial B_\infty$ is a Euclidean circle in ∂B_∞ with finite Euclidean diameter a_x . Since F_k is compact, the set of numbers $\{a_x; x \in F_k\}$ has a finite maximal value a_k . Let $a = \max\{a_1, \dots, a_{d_i}\}$, and let c be the maximal Euclidean diameter of the parallelograms $\{N_R(Z_1)^0 \cap E_{i,j}^0, \dots, N_R(Z_{d_i})^0 \cap E_{i,j}^0\}$. By taking n large enough, we can ensure that $N_R(Z_1)^0 \cap E_{i,j}^0, \dots, N_R(Z_{d_i})^0 \cap E_{i,j}^0$ are mutually far apart from

each other by Euclidean distance at least $a + c$. Then the convex hull will satisfy the condition $H_{i,j}^n \cap U_{i,j} = \{N_R(Z_1)^0, \dots, N_R(Z_{d_i})^0\}$. \square

The manifold $H_{i,j}^n$ provided by Lemma 8.1 is the multi- l -handle we were seeking. (Figure 4 gives an illustration of $H_{i,j}^n$ when $d_i = 4$). We may assume the choice of n works in constructing all the multi- l -handles $H_{i,j}^n$, $j = 1, \dots, n_i$, $i = 1, 2$.

We now glue the multi- l -handles $H_{i,j}^n$, $j = 1, \dots, n_i$, to J_i^- along $D_{i,j,k}$, $k = 1, \dots, d_i$, $j = 1, \dots, n_i$, (the gluing isometry should be clear). By our explicit construction, one can see that the hyperbolic structure on $H_{i,j}^n$ and the hyperbolic structure on J_i^- match up after the gluing, forming a global (convex) hyperbolic structure. Thus we obtain a compact, convex 3-manifold $C_n(J_i^-)$. We also have a local isometry $g_i: C_n(J_i^-) \rightarrow Y_i$, extending the local isometry $g_i: J_i^- \rightarrow Y_i$.

9 Strong separability in the free group

In this section, we present our main group theoretical result, (Theorem 9.1), which, together with the techniques used in its proof, will have crucial applications in this paper.

Let S^- be a connected, compact, orientable surface with genus g and with $b > 0$ boundary components. Fix a point s in S^- as the base point, and let $F = \pi_1(S^-, s)$. Then F is a free group. We may choose a free basis of F ,

$$a_1, b_1, a_2, b_2, \dots, a_g, b_g, x_1, \dots, x_{b-1},$$

such that

$$x_1, x_2, \dots, x_{b-1}, x_b = [a_1, b_1][a_2, b_2] \cdots [a_g, b_g] x_1 x_2 \cdots x_{b-1}$$

are represented by embedded loops in S^- (based at s) which are freely isotopic to the b boundary components of S^- respectively. An element γ of F is peripheral iff γ is conjugate to some power of some x_i . We prove the following:

Theorem 9.1 *Let $H \subset F$ be a finitely generated subgroup containing no nontrivial peripheral elements of F , and let $y_1, \dots, y_a \in F - H$. Then there exists a subgroup G of F , with $|F : G| = m < \infty$, such that G contains H but does not contain any elements of $\{y_1, \dots, y_a, x_i, x_i^2, \dots, x_i^{m-1} : i = 1, \dots, b\}$.*

In particular, the subgroup H is separable; indeed, by M Hall's Theorem, every finitely generated subgroup of F is separable. However, Theorem 9.1 gives much more

information about G , since the number of elements to be separated is tied up with the index of the subgroup G in F .

As an aside, we record a topological consequence of [Theorem 9.1](#), which may be of independent interest.

Corollary 9.2 *Let $f: \alpha \rightarrow S^-$ be an immersion of a geodesic loop in a hyperbolic surface S^- with $b > 0$ boundary components. Then f lifts to an embedding in a finite cover $\tilde{S}^- \rightarrow S^-$, such that \tilde{S}^- has exactly b boundary components.*

The proof of [Theorem 9.1](#) is based on a technique, due originally to Stallings and developed thoroughly in Kapovich and Myasnikov [\[11\]](#), of using folded graphs. We first need to recall some definitions, and refer to [\[11\]](#) for more details. Let L be a free basis for a free group F , and let L^{-1} be the set $\{x^{-1}; x \in L\}$. An L -labeled directed graph is a graph such that each edge of the graph is oriented, ie with an initial vertex and a terminal vertex assigned, and is labeled with a unique element of L . Given an L -labeled directed graph \mathcal{G} , we form an $L \cup L^{-1}$ -labeled graph $\widehat{\mathcal{G}}$ as follows: for each edge e of \mathcal{G} —say with label x , initial vertex v_1 and terminal vertex v_2 —add a new edge, denoted e^{-1} , with label x^{-1} , initial vertex v_2 and terminal vertex v_1 . The introduction of $\widehat{\mathcal{G}}$ is purely for technique convenience.

An L -labeled directed graph \mathcal{G} is said to be L -regular if, for every vertex v of \mathcal{G} and every $x \in L \cup L^{-1}$, there is exactly one edge of $\widehat{\mathcal{G}}$ with initial vertex v and with label x . An L -labeled directed graph \mathcal{G} is called *folded* if there is no pair of distinct edges e, e' in $\widehat{\mathcal{G}}$ with the same initial vertex and the same label. Obviously a regular graph is folded.

If \mathcal{G} is folded, then every reduced path (ie path containing no subpath of the form e, e^{-1}) in $\widehat{\mathcal{G}}$ determines a unique freely reduced word in $L \cup L^{-1}$, and thus a unique element of F . If we fix a vertex $v_0 \in \mathcal{G}$, then the set of all elements of F corresponding to the set of reduced loops in $\widehat{\mathcal{G}}$ based at v_0 is a subgroup of F , denoted $L(\mathcal{G}, v_0)$. A proof of the following lemma is contained in Kapovich and Myasnikov [\[11\]](#).

Lemma 9.3 *If \mathcal{G} is a finite and L -regular graph, then $L(\mathcal{G}, v_0)$ is a finite-index subgroup of F , and its index in F is equal to the number of vertices in \mathcal{G} .*

An example of an L directed graph \mathcal{G}_0 is the wedge of $|L|$ circles each given some fixed orientation and labeled with the labels of L , one each. If we denote the vertex by v_0 , then $L(\mathcal{G}_0, v_0) = F$. The point of [Lemma 9.3](#) is that a graph \mathcal{G} as given in the lemma is naturally a finite sheeted covering of the graph \mathcal{G}_0 with degree equal to the number of vertices of \mathcal{G} .

We now proceed to prove [Theorem 9.1](#). From now on in this section L denotes the free basis of the free group $F = \pi_1(S^-, s)$ given at the beginning of this section. We may certainly assume that F is not a cyclic group, and thus we have either $g > 0$, or $g = 0$ and $b > 2$. Elements of F will be considered as words in letters in $L \cup L^{-1}$. It follows directly from the proof of Hall's Theorem in [\[11\]](#) that there is a connected, finite, folded, L -labeled directed graph \mathcal{G}_0 , with base vertex v_0 , such that $L(\mathcal{G}_0, v_0) = H$, and the words y_1, \dots, y_a are representable by non-closed paths in $\widehat{\mathcal{G}}_0$ with the base vertex v_0 as their initial vertex. Also, no loop in $\widehat{\mathcal{G}}_0$ (based at any vertex) represents a non-zero power of any x_i , for otherwise H would contain nontrivial peripheral elements. Note that \mathcal{G}_0 is the quotient of the minimal H -invariant subtree of the Cayley graph of F with respect to the given generators.

We need some more definitions. Suppose that \mathcal{G} is a finite, connected, L -labeled directed graph. For each $i = 1, \dots, b$, we call a path in $\widehat{\mathcal{G}}$ an x_i -path if it represents a subword of the word x_i^k for some non-negative integer k . A single vertex of the graph is also considered as an x_i -path, corresponding to the empty subword of x_i . An x_i -path is called an x_i -loop if it is a loop representing the word x_i^k for some positive integer k . An x_i -path is called *maximal* if it is not contained in any other x_i -path besides itself. Now suppose further that \mathcal{G} is folded and $\widehat{\mathcal{G}}$ contains no x_i -loops, for all $i = 1, \dots, b$. Then for each $i = 1, \dots, b$, every x_i -path is contained in a unique maximal x_i -path with finite length (where the length of a path is the number of edges that the path contains). If $i < b$, then any maximal x_i -path is an embedded path, and any two different maximal x_i -paths are disjoint. For a maximal x_b -path, every oriented edge in the path appears only once in the path but the path may cross itself at some common vertices. Any two different maximal x_b -paths have disjoint oriented edges but may cross each other at some common vertices. It follows that there are only finitely many maximal x_i -paths in $\widehat{\mathcal{G}}$, which we denote by $C_{i,j}$, $i = 1, \dots, b$, $j = 1, \dots, m_i$. For a maximal x_i -path $C_{i,j}$, its initial (respectively terminal) vertex is missing an incoming (respectively outgoing) edge whose label is the predecessor (respectively successor) to the first (respectively the last) label of $C_{i,j}$, where $C_{i,j}$ is considered as a subword of the word x_i^k (for some $k \geq 0$). We shall call these two missing labels the *initial* and *terminal* missing labels of $C_{i,j}$ respectively. Of course if $i < b$, then the initial or terminal missing label for every $C_{i,j}$ is always x_i . Note that for a maximal x_b -path $C_{b,j}$, if the first label of $C_{b,j}$ is the letter a_1 , then the initial missing label of $C_{b,j}$ is the letter x_{b-1} if $b > 1$ or the letter b_g^{-1} if $b = 1$; and similarly if the last label of $C_{b,j}$ is the letter b_g^{-1} , then the terminal missing label of $C_{b,j}$ is the letter x_1 if $b > 1$ or the letter a_1 if $b = 1$.

Lemma 9.4 *Let \mathcal{G} be a finite, connected, L -labeled, directed graph such that \mathcal{G} is folded and such that $\widehat{\mathcal{G}}$ contains no x_i -loops for any $i = 1, \dots, b$. Then $x \in L$ is the*

initial missing label of some maximal x_i -path $C_{i,j}$ if and only if x is the terminal missing label for some maximal x_i -path $C_{i,j'}$.

Proof Suppose that the number of vertices of \mathcal{G} is m . Let k be the number of existing directed edges of \mathcal{G} with label x . Then $m - k$ is equal to the number of initial missing edges of $\widehat{\mathcal{G}}$ with label x and is also equal to the number of terminal missing edges of $\widehat{\mathcal{G}}$ with label x . The lemma follows. \square

We shall let:

$$L_* = \{a_1, b_1, \dots, a_g, b_g\}$$

The proof of the following lemma is obvious.

Lemma 9.5 Let \mathcal{G} be a finite connected L -labeled directed graph such that \mathcal{G} is folded and such that $\widehat{\mathcal{G}}$ contains no x_i -loops for any $i = 1, \dots, b$. If $x \in L_* \cup L_*^{-1}$ is the initial or terminal missing label of some $C_{b,j}$ at a vertex v , then x^{-1} must also be the terminal or initial missing label of some $C_{b,j'}$ respectively at the same vertex v .

By Lemma 9.3, it is enough to show that the graph \mathcal{G}_0 embeds in a finite L -regular graph \mathcal{G}_* such that $\widehat{\mathcal{G}}_*$ contains no x_i -loop (based at any vertex) representing the word x_i^k for any $i = 1, \dots, b$ and $k = 1, \dots, m_* - 1$, where m_* is the number of vertices of \mathcal{G}_* . Indeed, assuming such \mathcal{G}_* is found, we have:

- (1) $G = L(\mathcal{G}_*, v_0)$ is an index m_* subgroup of F (Lemma 9.3);
- (2) G contains H as a subgroup but does not contain any of the elements y_1, \dots, y_a (because \mathcal{G}_0 is an embedded subgraph of \mathcal{G}_* and y_1, \dots, y_a are represented by non-closed paths with initial vertex v_0);
- (3) G does not contain any of the elements x_i^k , $i = 1, \dots, b$, $k = 1, \dots, m_* - 1$ (because $\widehat{\mathcal{G}}_*$ has no x_i -loop representing the word x_i^k for any $i = 1, \dots, b$ and any $k = 1, \dots, m_* - 1$).

In the rest of this section we show that such a graph \mathcal{G}_* exists.

Definition Let \mathcal{G} be a finite, connected, L -labeled, directed graph such that \mathcal{G} is folded and such that $\widehat{\mathcal{G}}$ contains no x_i -loops for any $i = 1, \dots, b$. A graph \mathcal{G}' is called a *good extension* of \mathcal{G} if:

- (1) \mathcal{G}' is a finite, connected, L -labeled, directed graph;
- (2) \mathcal{G}' contains \mathcal{G} as an embedded subgraph;
- (3) \mathcal{G}' is folded;

(4) $\widehat{\mathcal{G}}'$ contains no x_i -loops for all $i = 1, \dots, b$.

Definition Let \mathcal{G} be a finite, connected, L -labeled, directed graph such that \mathcal{G} is folded and such that $\widehat{\mathcal{G}}$ contains no x_i -loops for any $i = 1, \dots, b$. A graph \mathcal{G}' is called a *perfect extension* of \mathcal{G} if:

- (1) \mathcal{G}' is a finite, connected, L -labeled, directed graph;
- (2) \mathcal{G}' contains \mathcal{G} as an embedded subgraph;
- (3) \mathcal{G}' is L -regular;
- (4) $\widehat{\mathcal{G}}'$ contains no loop representing the word x_i^k for any $i = 1, \dots, b$ and any $k = 1, \dots, m - 1$, where m is the number of vertices of \mathcal{G}' .

We shall describe a canonical procedure for constructing a finite sequence of graphs $\mathcal{G}_0, \mathcal{G}_1, \dots, \mathcal{G}_n$ such that:

- (1) \mathcal{G}_0 is the graph given above;
- (2) \mathcal{G}_{p+1} is a good extension of \mathcal{G}_p for each $p = 1, \dots, n - 2$ (if $n > 1$);
- (3) \mathcal{G}_n is a perfect extension of \mathcal{G}_{n-1} .

Obviously if such a sequence of graphs can be constructed, then \mathcal{G}_n will be the graph which we seek.

We divide our discussion into three cases: $b = 1$, $b = 2$ and $b > 2$. We need the following definitions for all the three cases.

Definitions For $g > 0$, let \mathcal{G} be a finite, connected, L -labeled, directed graph such that \mathcal{G} is folded and such that $\widehat{\mathcal{G}}$ contains no x_i -loops for any $i = 1, \dots, b$. Let $x \in L_* \cup L_*^{-1}$.

A maximal x_b -path $C_{b,j}$ of $\widehat{\mathcal{G}}$ is called a *type I maximal x_b -path with missing label x* if:

- (1) x is the initial missing label of $C_{b,j}$ and x^{-1} is the terminal missing label of the same path $C_{b,j}$;
- (2) the initial vertex and the terminal vertex of $C_{b,j}$ are the same vertex.

A maximal x_b -path $C_{b,j}$ of $\widehat{\mathcal{G}}$ is called a *type II maximal x_b -path with missing label x* (again we assume that $g > 0$) if x is the initial missing label of $C_{b,j}$ and is also the terminal missing label of the same path.

Figure 5 (a) illustrates a pair of type I maximal x_b -paths, and Figure 5 (b) shows a pair of type II maximal x_b -paths. In these figures, a missing label is represented by a dotted, labeled edge; the initial missing label is given at the left end of a path and the terminal one at the right end.



Figure 5

Case 1 $b = 1$

In this case, we have $g > 0$, free basis $L = L_* = \{a_1, b_1, \dots, a_g, b_g\}$, and a surface S^- with a single boundary component, which is freely isotopic to a loop representing the commutator $x_b = x_1 = [a_1, b_1] \cdots [a_g, b_g]$.

Start with the graph \mathcal{G}_0 . Since $\widehat{\mathcal{G}}_0$ has no x_b -loops, every maximal x_b -path in $\widehat{\mathcal{G}}_0$ has both initial and terminal missing labels. Suppose that x is a missing label. Then $x \in L_* \cup L_*^{-1}$. By Lemmas 9.4 and 9.5, we have maximal x_b -paths (possibly non-distinct) $C_{b,j}, C_{b,j'}, C_{b,k}, C_{b,k'}$, with missing labels as illustrated on the left hand side in Figure 6. Note that although we draw these paths separately, they may actually share some common vertices. Also a path we draw may not be simply connected, ie some of its vertices maybe the same vertex. Note also that instead of drawing an oriented edge with label x^{-1} , we often draw, equivalently, an edge with the opposite orientation and with label x (ie every edge we draw shall be considered as two directed edges with opposite orientations and inverse labels). Also, a pair of paths in the figure may in fact be non-distinct (eg maybe $C_{b,j} = C_{b,j'}$). However, the four paths given on the left hand side in Figure 6 must satisfy $C_{b,j} \neq C_{b,k}$ and $C_{b,j'} \neq C_{b,k'}$.

Operation 1 Suppose that the four maximal x_b -paths given in Figure 6 satisfy: $C_{b,j} \neq C_{b,j'}$, $C_{b,k} \neq C_{b,k'}$, and either $C_{b,j} \neq C_{b,k'}$ or $C_{b,j'} \neq C_{b,k}$. Then we may perform the following operation: add a new vertex w ; for each letter in $L - \{x\}$ add a new edge with both its initial and terminal vertices at w and with that letter as the label; add a new edge with label x , initial vertex v and terminal vertex w ; and add a new edge with label x , initial vertex w and terminal vertex v' . A piece of the resulting graph is shown on the right hand side in Figure 6, where there are exactly $2g - 1$ single-edge loops at the new vertex w , with labels one each from $L - \{x\}$.

We claim that the resulting graph is a good extension of \mathcal{G}_0 , and that the number of maximal x_b -paths in the new graph is reduced. Indeed, the new graph is obviously

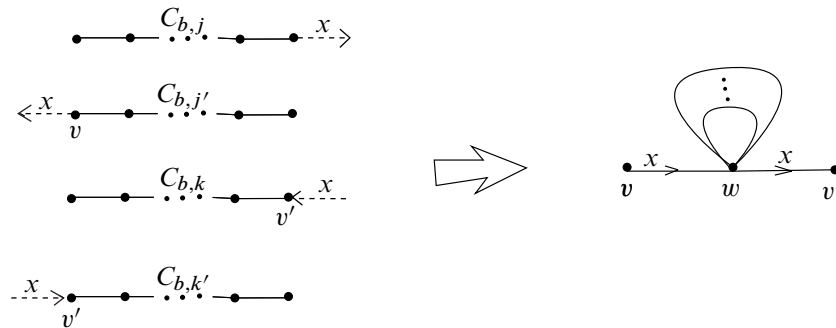

Figure 6

finite, connected, L -labeled and contains \mathcal{G}_0 as an embedded subgraph, and one can check that it is folded. One can also check that the number of maximal x_b -paths in the new graph is reduced. Namely the maximal x_b -paths $C_{b,j}$ and $C_{b,j'}$ are joined into a single maximal x_b -path, as are $C_{b,k}$ and $C_{b,k'}$. No extra maximal x_b -paths are created, since all the added edges are used in the two new maximal x_b -paths. In particular no x_b -loops are created.

Operation 2 Suppose that the four maximal x_b -paths given in Figure 6 satisfy: $C_{b,j} \neq C_{b,k'}$, $C_{b,j'} \neq C_{b,k}$ and either $C_{b,j} \neq C_{b,j'}$ or $C_{b,k} \neq C_{b,k'}$. Then we may perform the following operation: add a new edge e with the label x , initial vertex v and terminal vertex v' . Again one can easily check that the resulting graph from an operation 2 is a good extension of the old graph, and the number of maximal x_b -paths in the new graph is reduced.

For each pair $\{x, x^{-1}\}$, we perform Operations 1 and 2 as many times as possible. Since each operations reduces the number of maximal x_b -paths, this process will terminate in a graph \mathcal{G}_1 for which neither Operation 1 nor Operation 2 may be applied for any pair $\{x, x^{-1}\}$.

Lemma 9.6

- (1) \mathcal{G}_1 is a good extension of \mathcal{G}_0 .
- (2) In $\widehat{\mathcal{G}}_1$, for each letter pair $\{x, x^{-1}\}$, one of the following holds:
 - I* every maximal x_b -path with x or x^{-1} as an initial or terminal missing label is of Type I; or
 - II* there are only two maximal x_b -paths which have x or x^{-1} as a missing label; moreover one of the two paths is a type II maximal x_b -path with x as its missing label and the other path is a type II maximal x_b -path with x^{-1} as a missing label; or

III there is no maximal x_b -path with x or x^{-1} as an initial or terminal missing label.

Proof Part (1) of the lemma holds since we have checked that Operations 1 and 2 always yield good extensions.

To show part (2) of the lemma, fix a letter pair $\{x, x^{-1}\}$, and suppose that case III does not happen. Then as discussed above, in $\widehat{\mathcal{G}}_1$ we have maximal x_b -paths $C_{b,j}$, $C_{b,j'}$, $C_{b,k}$ and $C_{b,k'}$ (possibly non-distinct) as shown in Figure 6. If $C_{b,j} = C_{b,j'}$, then we must have $C_{b,k} = C_{b,k'}$, and vice versa. For otherwise Operation 2 would apply. It follows that if $C_{b,j} = C_{b,j'}$ or $C_{b,k} = C_{b,k'}$ are the same path, then any other such pair of paths must be the same, ie Case I holds. So we may assume that for any two pairs of maximal x_b -paths $(C_{b,j}, C_{b,j'})$ and $(C_{b,k}, C_{b,k'})$ as shown in Figure 6, we have $C_{b,j} \neq C_{b,j'}$ and $C_{b,k} \neq C_{b,k'}$. But since Operation 1 does not apply to them, we must have $C_{b,j} = C_{b,k'}$ and $C_{b,j'} = C_{b,k}$. Thus we have a pair of Type II maximal x_b -paths with x and x^{-1} as their missing labels, respectively. Again since Operation 1 does not apply, there is at most one such pair, ie case II occurs. \square

Operation 3 Suppose that $\widehat{\mathcal{G}}_1$ satisfies Property I of Lemma 9.6, for some letter pair $\{x, x^{-1}\}$. Let k be the total number of pairs of Type I maximal x_b -paths with missing labels in $\{x, x^{-1}\}$. Then we may perform the operation shown in Figure 7 to change all of them into a single pair of Type II maximal x_b -paths with a letter different from x or x^{-1} as the missing label. For illustration, in Figure 7 we assume that $k = 3$ and $x = a_1$. We add three new vertices w_1, w_2, w_3 , two new edges with label b_1 , and new loops at each w_i having labels one each from $L_* - \{a_1, b_1\}$. The three pairs of type I maximal x_b -paths with missing label a_1 and a_1^{-1} become one pair of type II maximal x_b -paths with missing label b_1 and b_1^{-1} . All the added new edges are used in this pair of new maximal x_b -paths. If the missing labels for the type I pairs are b_1 and b_1^{-1} instead of a_1 and a_1^{-1} , then in Figure 7 we exchange the letters a_1 and b_1 . In general, for arbitrary k and arbitrary missing label pair $\{x, x^{-1}\}$, it should be clear how to make a similar operation.

Again one can check that, if Operation 3 is applied to a good extension, then the resulting graph is a good extension. Also, after Operation 3 is applied, the k pairs of Type I paths are replaced with a single pair of Type II paths, whose missing labels are different from $\{x, x^{-1}\}$. If $\{x, x^{-1}\} = \{a_i, a_i^{-1}\}$, then the new label pair is $\{b_i, b_i^{-1}\}$, and vice versa. Note that after applying Operation 3, the total number of maximal x_b -paths cannot increase, although it may stay the same.

Now, starting with the graph \mathcal{G}_1 , we perform Operation 3 as many times as possible. We are left with a graph, \mathcal{G}_2 , whose maximal x_b -paths are all of Type II. Suppose \mathcal{G}_2 has more than one pair of Type II maximal x_b -paths with missing labels in $\{x, x^{-1}\}$.

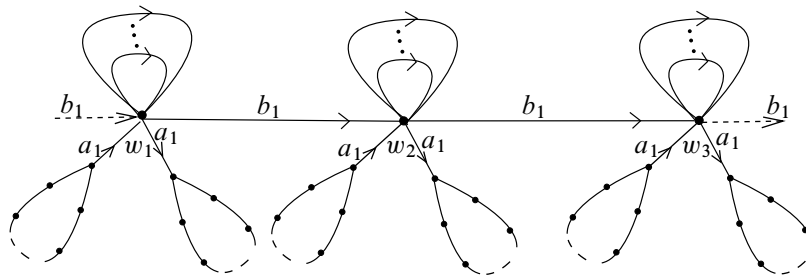

Figure 7

Then we may apply Operation 2. The effect is to replace a pair of Type II paths with a single Type II path. Therefore, after performing Operation 2 repeatedly, we arrive at a graph \mathcal{G}_3 , such that, for every missing label pair $\{x, x^{-1}\}$, there is exactly one pair of Type II paths corresponding to that pair, and there are no other maximal x_b -paths with x or x^{-1} as missing label. Note that \mathcal{G}_3 cannot be L -regular, since our operations thus far never create an x_b -loop.

Operation 4 We add a single vertex w , and then add the appropriate edges to make the graph folded, with no missing labels from L_* . This is illustrated in Figure 8 in the case where there are exactly three pairs of maximal x_b -paths, with missing labels $\{x, x^{-1}\}, \{x', x'^{-1}\}, \{x'', x''^{-1}\}$. The loops at the added vertex w have labels from the remaining labels in L_* .

The resulting graph \mathcal{G}_4 is what we wanted, ie it is a perfect extension of \mathcal{G}_3 . Indeed, it is easy to check that the graph is finite, connected, and folded, with \mathcal{G}_3 as an embedded subgraph; also, in the current case, $L_* = L$, so \mathcal{G}_4 is L -regular. So we only need to check that $\widehat{\mathcal{G}}_4$ has no x_b -loops representing the word x_b^k for any $k = 1, \dots, m - 1$, where m is the number of vertices of \mathcal{G}_4 . To see this holds, refer to Figure 8, and trace out an x_b -loop, starting at any vertex of \mathcal{G}_4 . One sees that an x_b -loop does not occur until every edge of $\widehat{\mathcal{G}}_4$ has been used exactly once (in particular each maximal x_b -path $C_{b,j}$ in $\widehat{\mathcal{G}}_3$ has been traced out exactly once). This x_b -loop represents the word x_b^m , since \mathcal{G}_4 is L -regular and contains m vertices. This completes the proof of Theorem 9.1 when $b = 1$.

Case 2 $b = 2$

In this case, the free basis $L = \{a_1, b_1, \dots, a_g, b_g, x_1\}$, and we also have $x_b = x_2 = [a_1, b_1] \cdots [a_g, b_g] x_1$ (note that $g > 0$ in this case too). Recall $L_* = \{a_1, b_1, \dots, a_g, b_g\}$.

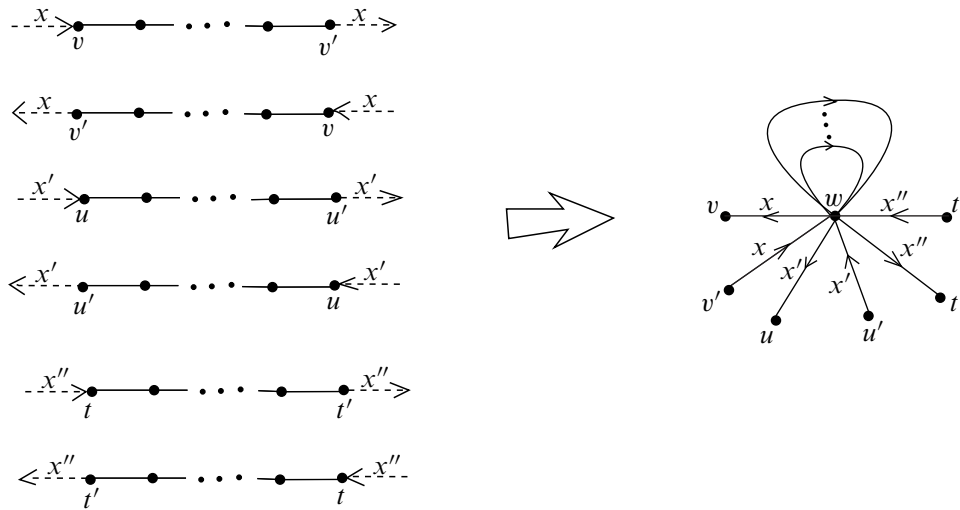

Figure 8

The first step in this case is to construct a good extension graph \mathcal{G}_1 of \mathcal{G}_0 such that $\widehat{\mathcal{G}}_1$ has no missing label pairs from $L_* \cup L_*^{-1}$. The procedure for constructing such \mathcal{G}_1 is the same as that given in Case 1. Only in the current case, after applying an Operation 1, or 3, or 4, we may increase the number of maximal x_b -paths with missing label x_1 and may also increase the number of maximal x_1 -paths. But no x_1 -loops will be created because during each of these operations no new edge with label x_1 is added.

Let \mathcal{G}_1 be the resulting good extension graph after all missing edges with labels from L_* are eliminated. So every maximal x_b -path $C_{b,j}$ in $\widehat{\mathcal{G}}_1$ has both its initial and terminal missing labels being x_1 . In the current case, we also need to consider maximal x_1 -paths. Their missing labels are of course always x_1 . Note also that in $\widehat{\mathcal{G}}_1$ the number of maximal x_b -paths is the same as the number of maximal x_1 -paths (since $b = 2$ and since x_1 is now the only missing label from L). Suppose that there are at least three maximal x_b -paths in $\widehat{\mathcal{G}}_1$. We illustrate three such paths in Figure 9 left hand side. Thus there are at least three maximal x_1 -paths, which are shown in Figure 9 right hand side. Since the graph \mathcal{G}_1 is connected and folded, the vertices shown in Figure 9 satisfy $v_1 \neq v_3 \neq v_5 \neq v_1$, $v_2 \neq v_4 \neq v_6 \neq v_2$. Also $C_{1,1}$, $C_{1,2}$, $C_{1,3}$ are mutually disjoint embedded paths. By adding to v_2 a subgraph which is shown in Figure 10 (in the figure, the loops have labels one each from L_*), we may assume that $v_2 \neq v_3$ and $v_2 \neq v_5$. We may also assume that $v_2 = w_2$, and $v_3 \neq w_1$. Now we simply add an edge with label x_1 to \mathcal{G}_1 pointing from v_2 to v_3 . Then the new graph is folded with one less number of maximal x_b -paths, and with no x_i -loops created, $i = 1, 2$ (since v_3 is not an end vertex in the path $C_{1,1}$).

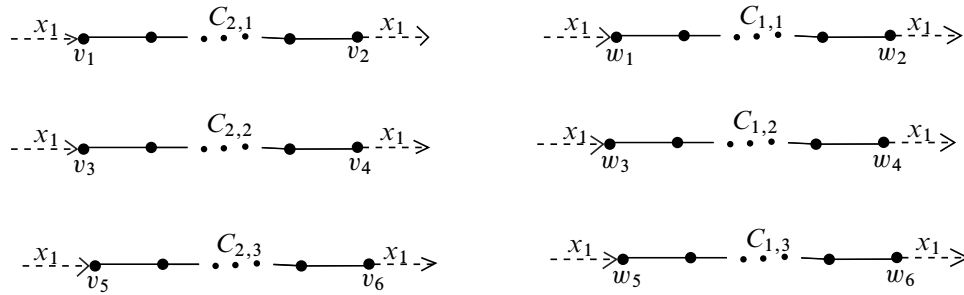

Figure 9

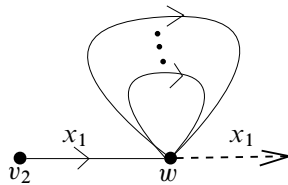

Figure 10

So we may assume we have a graph, still denoted \mathcal{G}_1 , such that $\widehat{\mathcal{G}}_1$ has at most two maximal x_b -paths. If there is only one such path, we simply add a single edge with the missing label x_1 . The resulting graph is what we requested. So we may assume that there are exactly two such paths, as shown in Figure 11. Again we have $v_1 \neq v_3$, $v_2 \neq v_4$ and may assume $v_2 \neq v_3$ and $v_2 = w_2$. If $v_3 \neq w_1$, then we simply add an edge with label x_1 pointing from v_2 to v_3 . So we may assume that $v_3 = w_1$. In such case we cannot add an edge from v_2 to v_3 with label x_1 since that will create a graph which has an x_1 -loop but is not yet L -regular. The initial and terminal vertices of these paths are illustrated in the first two rows of Figure 12. Now we take an identical copy \mathcal{G}'_1 of the graph \mathcal{G}_1 . The corresponding maximal x_i -paths in $\widehat{\mathcal{G}}'_1$ are denoted by $C'_{i,j}$. The union of these paths from the two graphs are shown in Figure 12. We now connect these two graphs together as follows: add an edge from v_2 to v'_1 , add an edge from v_4 to v'_3 , add an edge from v'_2 to v_3 , and add an edge from v'_4 to v_1 , all with label x_1 . Then one can easily check that the resulting graph is what we requested. This proves the theorem when $b = 2$.

Case 3 $b \geq 3$

Again we first eliminate all missing labels belonging to $L_* = \{a_1, b_1, \dots, a_g, b_g\}$, with a similar method as in Case 2. Namely during the relevant operations, no new edges with label x_i , $i = 1, \dots, b - 1$ are added. Note that the resulting graph \mathcal{G}_1 must

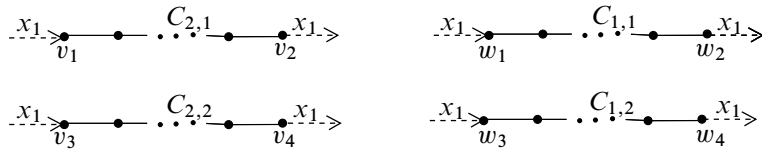

Figure 11

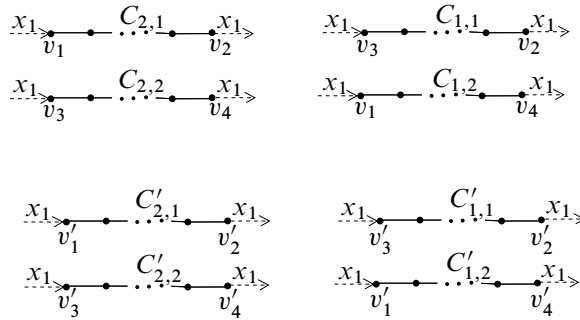

Figure 12

have missing x_i -labels for each $i = 1, \dots, b - 1$ (since no x_i -loops were created). Let $C_{b,j}$ be a maximal x_b -path in $\widehat{\mathcal{G}}_1$. Its initial missing label might not be the same as its terminal missing label. If so, we call such path a maximal x_b -path with mixed missing labels. Note that for each $i = 1, \dots, b - 1$, the number of initial missing x_i labels is equal to the number of terminal missing x_i labels. It follows that if the graph $\widehat{\mathcal{G}}_1$ has a maximal x_b -path $C_{b,j}$ with mixed missing labels and with x_1 , say, as the terminal missing label, then there must be another maximal x_b -path $C_{b,j'}$ with mixed missing labels and with x_1 as the initial missing label, and vice versa.

Take $b - 1$ maximal x_b -paths with mutually distinct terminal missing labels. Such $b - 1$ paths must exist as we already noted. By adding a subgraph as shown in Figure 13 to the $b - 1$ terminal vertices of the maximal x_b -paths (in Figure 13, loops at the vertex w have labels from L_*) we may assume that the terminal vertex is different from the initial vertex for every one of these $b - 1$ maximal x_b -paths, and we may also assume that the graph has a maximal x_b -path with mixed missing labels. Note that the operation given in Figure 13 results in a good extension, and does not change the number of maximal x_b -paths. Together with the notes given in the preceding paragraph, we see that for any given label x_i , $i = 1, \dots, b - 1$, we may change our graph with the operation given in Figure 13 so that the resulting graph has a maximal x_b -path with mixed missing labels and with x_i as the terminal missing label, without increasing the total number of maximal x_b -paths.

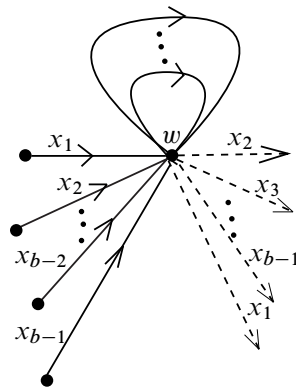

Figure 13

Now suppose that there is a maximal x_b -path $C_{b,1}$ with mixed missing labels and with x_1 , say, as terminal missing label, and suppose that there are at least two maximal x_1 -paths in the graph. Then there are at least two maximal x_b -paths $C_{b,2}$ and $C_{b,3}$ which have x_1 as their initial missing label. The situation is illustrated in Figure 14. We may assume that $v_2 = w_2$. We may assume one of v_3 and v_5 , say v_3 , is different from w_1 since the graph is folded. Now we add an edge connecting v_2 to v_3 with the label x_1 . Then no x_b -loop is created since $C_{b,1}$ has mixed missing labels. Also no x_1 -loop is created since $v_2 \neq v_3$ and $v_3 \neq w_1$. But the number of maximal x_b -paths is reduced.

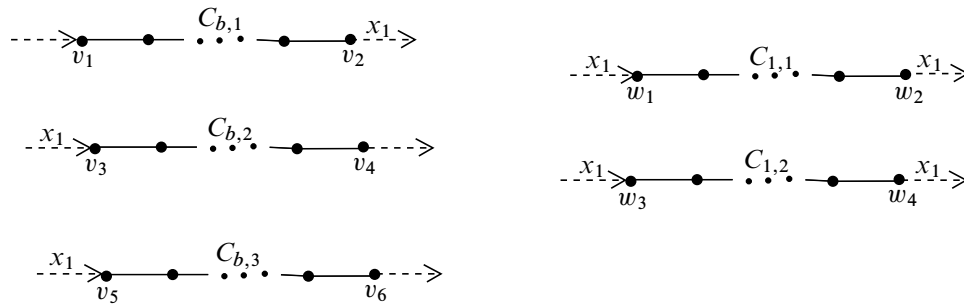

Figure 14

Repeating such operation, we may assume that our graph has exactly one maximal x_i -path for each $i = 1, 2, \dots, b - 1$. Thus there are exactly $b - 1$ maximal x_b -paths, $C_{b,i}$, $i = 1, \dots, b - 1$. We may assume that the initial missing label of $C_{b,i}$ is x_i for $i = 1, \dots, b - 1$. Then the terminal missing label of $C_{b,i}$ is $x_{\sigma(i)}$ for some permutation σ of the set $\{1, 2, \dots, b - 1\}$. Suppose that σ has order n . We take n copies of the graph and connect them as indicated in Figure 15.

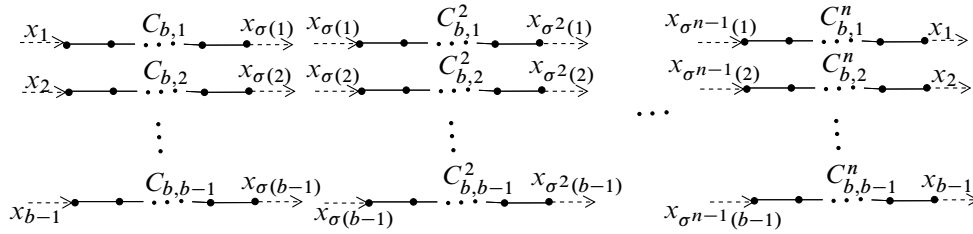

Figure 15

The resulting graph again has exactly $b - 1$ maximal x_b -paths, but the permutation of their missing labels is the identity now. By adding the subgraph in Figure 13 to the graph at the right side, the permutation becomes a cyclic permutation $i \rightarrow i + 1$, $i = 1, \dots, b - 1$ (defined mod $b - 1$). Now we simply fill in $b - 1$ edges at the obvious places with the right labels. The resulting graph is what we wanted.

The proof of Theorem 9.1 is finally completed.

Remark 9.7 Note that the arguments in this section actually show that if $\mathcal{G}_\#$ is a finite, L -labeled, directed, folded graph with base vertex v_0 , with corresponding subgroup $G_\# = L(\mathcal{G}_\#, v_0) \subset F = \pi_1(S^-, s)$, such that

- $\mathcal{G}_\#$ does not contain any loop representing the word x_i^j for any $i = 1, \dots, b$, $j \in \mathbb{Z} - \{0\}$, and
- y_1, \dots, y_r are some fixed, non-closed paths based at v_0 in $\mathcal{G}_\#$, then there is a finite, connected, L -regular graph \mathcal{G}_* such that
- \mathcal{G}_* contains $\mathcal{G}_\#$ as an embedded subgraph, and thus in particular y_1, \dots, y_a remain non-closed paths based at v_0 in \mathcal{G}_* , and
- \mathcal{G}_* contains no loops representing the word x_i^j , for each $i = 1, \dots, b$, $j = 1, \dots, m_* - 1$, where m_* is the number of vertices of \mathcal{G}_* .

That is, the graph \mathcal{G}_* is a perfect extension of $\mathcal{G}_\#$.

In terms of groups, $L(\mathcal{G}_*, v_0)$ represents a subgroup G_* of F of index m_* such that

- G_* contains $G_\#$ as a subgroup;
- G_* does not contain any of the elements x_i^j , $i = 1, \dots, b$, $j = 1, \dots, m_* - 1$;
- G_* does not contain any of the elements y_1, \dots, y_r (considered as words in the generators in $L \cup L^{-1}$).

This remark will be used later in Section 11.

10 Lifting immersions to embeddings

We recall some of the notations from earlier sections. Each of i, i_* denotes a number 1 or 2 such that $\{i, i_*\} = \{1, 2\}$. We have the universal covering maps $p: \mathbb{H}^3 \rightarrow M$, $p|: \mathbb{H}^3 \setminus \mathcal{B} \rightarrow M^-$, $p_i: X_i = \tilde{S}_i \times I \rightarrow Y_i = S_i \times I$, and $p_i|: X_i^- = \tilde{S}_i^- \times I \rightarrow Y_i^- = S_i^- \times I$. We have a local isometry $f_i: Y_i = S_i \times I \rightarrow M$ such that $f_i|: (Y_i^- = S_i^- \times I, \partial_p Y_i^- = \partial S_i^- \times I) \rightarrow (M, \partial M)$ is a proper map and such that $f_i: \partial S_i^- \rightarrow \partial M$ is an embedding. The surface S_i^- has n_i boundary components $\{\beta_{i,j}, j = 1, \dots, n_i\}$ with induced orientation. There are $d = \Delta n_1 n_2$ intersection points $\{t_j, j = 1, \dots, d\}$ between $f_1(\partial S_1^-)$ and $f_2(\partial S_2^-)$ in ∂M . The points in $f_i^{-1}\{t_1, \dots, t_d\}$ are $\{t_{i,j,k}, j = 1, \dots, n_i, k = 1, \dots, d_i\}$, where $d_i = \Delta n_{i_*}$, indexed so that $\{t_{i,j,k}, k = 1, \dots, d_i\}$ are contained successively in the component $\beta_{i,j}$ (following the orientation of $\beta_{i,j}$) for each $j = 1, \dots, n_i$. We constructed a metrically complete, convex, hyperbolic 3-manifold J_i with a local isometry $g_i: J_i \rightarrow Y_i$ such that $g_i|: (J_i^-, \partial_p J_i^-) \rightarrow (Y_i^-, \partial_p Y_i^-)$ is a proper map. The parabolic boundary of J_i^- , $\partial_p J_i^-$, has exactly d components $\{D_{i,j,k}, j = 1, \dots, n_i, k = 1, \dots, d_i\}$, and the topological center point of $D_{i,j,k}$ is denoted $b_{i,j,k}$. We have $g_i(b_{i,j,k}) = t_{i,j,k}$. For each sufficiently large integer $n > 0$, we constructed a compact, convex, hyperbolic 3-manifold $C_n(J_i^-)$ which contains J_i^- as an embedded submanifold, and a local isometry $g_i: C_n(J_i^-) \rightarrow Y_i$, extending the map $g_i: J_i^- \rightarrow Y_i$.

Base point convention From now on, we will fix t_1 as a basepoint for each of M , M^- and ∂M , and $t_{i,1,1}$ will be the base point for each of S_i , S_i^- , Y_i and Y_i^- . After re-ordering $\{t_1, \dots, t_d\}$, we may assume that $f_i(t_{i,1,1}) = t_1$ for $i = 1, 2$, and that the point $\tilde{b} = \tilde{S}_1 \cap \tilde{S}_2 \cap \partial B_\infty$ is in $p^{-1}(t_1)$. The point \tilde{b} will be the base point for each of \mathbb{H}^3 , X_i , X_i^- , \tilde{S}_i , \tilde{S}_i^- , and ∂B_∞ . The point $b_{i,1,1}$ will be the base point for each of J_i , J_i^- , \hat{J}_i and $C_n(J_i^-)$. Under these choices of base points, we can identify, as in Section 4, each of $\pi_1(M, t_1)$ and $\pi_1(M^-, t_1)$ with the group Γ ; identify each of $\pi_1(S_i, t_{i,1,1})$, $\pi_1(S_i^-, t_{i,1,1})$, $\pi_1(Y_i, t_{i,1,1})$, $\pi_1(Y_i^-, t_{i,1,1})$ with the quasi-Fuchsian group $\Gamma_i \subset \Gamma$; and identify $\pi_1(\partial M, t_1)$ with the stabilizer of ∞ in Γ . Under such identifications, the induced map $f_i^*: \pi_1(S_i, t_{i,1,1}) = \Gamma_i \rightarrow \pi_1(M, t_1) = \Gamma$ is the inclusion homomorphism, and each of the inclusion maps $(S_i, t_{i,1,1}) \subset (Y_i, t_{i,1,1})$, $(S_i^-, t_{i,1,1}) \subset (Y_i^-, t_{i,1,1})$, $(S_i^-, t_{i,1,1}) \subset (S_i, t_{i,1,1})$, $(Y_i^-, t_{i,1,1}) \subset (Y_i, t_{i,1,1})$ and $(M^-, t_1) \subset (M, t_1)$ induces the identity isomorphism on the fundamental groups.

Choice of a free basis for Γ_i Recall that n_i is the number of boundary components of the truncated surface S_i^- . Let g_i be the genus of S_i^- . As in Section 9, the group $\Gamma_i = \pi_1(S_i^-, t_{i,1,1}) = \pi_1(Y_i, t_{i,1,1}) = \pi_1(S_i, t_{i,1,1}) = \pi_1(Y_i, t_{i,1,1})$ has a set of

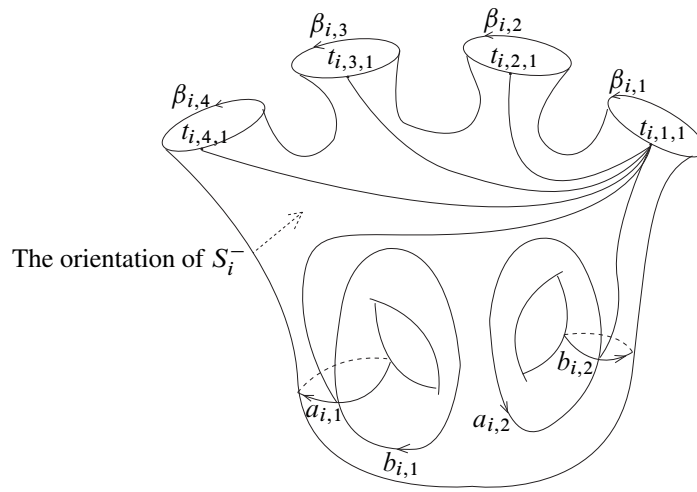

Figure 16: Choice of generators for $\pi_1(S_i^-, t_{i,1,1})$

generators

$$X = \{a_{i,1}, b_{i,1}, \dots, a_{i,g_i}, b_{i,g_i}, x_{i,1}, \dots, x_{i,n_i-1}\}$$

such that the elements

$$x_{i,1}, x_{i,2}, \dots, x_{i,n_i-1}, x_{i,n_i} = [a_{i,1}, b_{i,1}][a_{i,2}, b_{i,2}] \cdots [a_{i,g_i}, b_{i,g_i}]x_{i,1}x_{i,2} \cdots x_{i,n_i-1}$$

have representative loops freely homotopic to the n_i boundary components of S_i^- respectively. In the current case, we pick representative loops based at the point $t_{i,1,1}$ for the elements $a_{i,1}, b_{i,1}, \dots, a_{i,g_i}, b_{i,g_i}, x_{i,1}, \dots, x_{i,n_i-1}$ as shown in Figure 16. For instance $x_{i,2}$ is represented by the loop which goes along the given arc from $t_{i,1,1}$ to $t_{i,2,1}$, then goes around $\beta_{i,2}$ once following the given orientation and then comes back to $t_{i,1,1}$ along the given arc from $t_{i,2,1}$ to $t_{i,1,1}$. The representative for x_{i,n_i} is obtained similarly, except that in this case, we choose a loop which disagrees with the orientation of β_{i,n_i} . Then it is easy to see that

$$x_{i,n_i} = [a_{i,1}, b_{i,1}][a_{i,2}, b_{i,2}] \cdots [a_{i,g_i}, b_{i,g_i}]x_{i,1}x_{i,2} \cdots x_{i,n_i-1}$$

is in fact satisfied.

Choice of generators for $\pi_1(C_n(J_i^-), b_{i,1,1})$ Recall from the construction of $C_n(J_i^-)$ that $C_n(J_i^-)$ is obtained by gluing together J_i^- and n_i multi-1-handles $H_{i,1}^n, \dots, H_{i,n_i}^n$ along the parabolic regions $D_{i,j,k}$, $j = 1, \dots, n_i, k = 1, \dots, d_i$, of J_i^- . Recall that $b_{i,j,k}$ is the center point of $D_{i,j,k}$ which maps to $t_{i,j,k}$.

Let $\alpha_{i,j,k} \subset J_i^-$ be a fixed, oriented path from $b_{i,1,1}$ to $b_{i,j,k}$, $j = 1, \dots, n_i, k = 1, \dots, d_i$ ($\alpha_{i,1,1}$ is the constant path). For $j = 1, \dots, n_i, 1 \leq k \leq d_i - 1$, let $\delta_{i,j,k}(n)$ be the oriented geodesic arc in $H_{i,j}^n$ from $b_{i,j,k}$ to $b_{i,j,k+1}$. For $1 \leq k \leq d_i - 1$, let $z_{i,j,k}(n)$ be the loop $\alpha_{i,j,k} \cdot \delta_{i,j,k} \cdot \overline{\alpha_{i,j,k+1}}$, where the symbol “ \cdot ” denotes path concatenation (sometimes omitted), and $\overline{\alpha_{i,j,k}}$ denotes the reverse of $\alpha_{i,j,k}$. Also we always write path (in particular loop) concatenation from left to right. We also consider $z_{i,j,k}(n)$ as an element of $\pi_1(C_n(J_i^-), b_{i,1,1})$. Fix a set of generators $w_{i,1}, \dots, w_{i,\ell_i}$ for $\pi_1(J_i^-, b_{i,1,1})$. Then it's not hard to see, by recalling the structure of $H_{i,j}^n$, that $\pi_1(C_n(J_i^-), b_{i,1,1})$ is generated by the set of elements

$$w_{i,1}, \dots, w_{i,\ell_i}, z_{i,j,k}(n), 1 \leq j \leq n_i, 1 \leq k \leq d_i - 1.$$

In fact

$$\pi_1(C_n(J_i^-), b_{i,1,1}) = \pi_1(J_i^-, b_{i,1,1}) * \langle z_{i,j,k}(n) \mid 1 \leq j \leq n_i, 1 \leq k \leq d_i - 1 \rangle,$$

where $*$ denotes the free product, and $\langle z_{i,j,k}(n) \mid 1 \leq j \leq n_i, 1 \leq k \leq d_i - 1 \rangle$ is the free group freely generated by the $z_{i,j,k}(n)$'s.

By Lemma 4.2, the local isometry $g_i: (C_n(J_i^-), b_{i,1,1}) \rightarrow (Y_i, t_{i,1,1})$ induces an injective homomorphism $g_i^*: \pi_1(C_n(J_i^-), b_{i,1,1}) \rightarrow \Gamma_i = \pi_1(Y_i, t_{i,1,1})$. If α is an oriented arc in $C_n(J_i^-)$, we use α^* to denote the oriented arc $g_i \circ \alpha$ in Y_i . We use γ^* to denote the image of an element γ of $\pi_1(C_n(J_i^-), b_{i,1,1})$ under the map g_i^* . Then $g_i^*(\pi_1(C_n(J_i^-), b_{i,1,1}))$ is generated by the set of elements

$$w_{i,1}^*, \dots, w_{i,\ell_i}^*, z_{i,j,k}(n)^*, 1 \leq j \leq n_i, 1 \leq k \leq d_i - 1.$$

Now consider the images of these generators in Y_i . The oriented path $\alpha_{i,j,k}^*$ in Y_i^- runs from $t_{i,1,1}$ to $t_{i,j,k}$. For $j = 1, \dots, n_i, 1 \leq k \leq d_i - 1$, let $\eta_{i,j,k}$ be an oriented arc in $\beta_{i,j}$ from $t_{i,j,k}$ to $t_{i,j,k+1}$ following the orientation of $\beta_{i,j}$, and let $\sigma_{i,j,k} \subset Y_i^-$ be the loop $\alpha_{i,j,k}^* \cdot \eta_{i,j,k} \cdot \overline{\alpha_{i,j,k+1}^*}$. Let $\sigma_{i,j,0}$ be the constant path based at $t_{i,1,1}$. Let $x'_{i,j}$ be the loop $\alpha_{i,j,1}^* \cdot \beta_{i,j} \cdot \overline{\alpha_{i,j,1}^*}$, where $\beta_{i,j}$ is considered an oriented loop starting and ending at the point $t_{i,j,1}$.

Lemma 10.1 *Considered as an element in Γ_i ,*

$$z_{i,j,k}(n)^* = (\overline{\sigma_{i,j,k-1}} \cdots \overline{\sigma_{i,j,0}})(x'_{i,j})^n(\sigma_{i,j,0} \cdots \sigma_{i,j,k}),$$

for each $j = 1, \dots, n_i, k = 1, \dots, d_i - 1$.

Proof From the construction of $H_{i,j}^n$, we see that the arc $\delta_{i,j,k}(n)^*$ is isotopic in Y_i , with the endpoints fixed, to an arc which: starts from the point $t_{i,j,k}$, goes around $\beta_{i,j}$ exactly n times (following the orientation of $\beta_{i,j}$), then continues along $\beta_{i,j}$

until it reaches the point $t_{i,j,k+1}$. Now it is easy to check that the loop $z_{i,j,k}(n)^*$ is homotopic in Y_i , fixing the base point $t_{i,1,1}$, to the loop:

$$(\overline{\sigma_{i,j,k-1}} \cdots \overline{\sigma_{i,j,0}})(x'_{i,j})^n(\sigma_{i,j,0} \cdots \sigma_{i,j,k})$$

This proves the lemma. \square

Remark 10.2 The elements $\sigma_{i,j,k}$ $j = 1, \dots, n_i, k = 1, \dots, d_i - 1$, are independent of the integer n .

Definition Suppose that $\check{p}_i: \check{\beta}_{i,j} \rightarrow \beta_{i,j}$ is a covering map, and let $\check{\beta}_{i,j}$ have orientation induced from $\beta_{i,j}$. Let $\alpha \subset \check{\beta}_{i,j}$ be an embedded, connected, compact arc with orientation induced from $\check{\beta}_{i,j}$, whose initial point is in $\check{p}_i^{-1}(t_{i,j,k})$ and whose terminal point is in $\check{p}_i^{-1}(t_{i,j,k+1})$ (here $k+1$ is defined mod d_i). We say that α has *wrapping number* n if there are exactly n distinct points of $\check{p}_i^{-1}(t_{i,j,k})$ which are contained in the interior of α .

In the next section we show the following.

Proposition 10.3 For each $i = 1, 2$ and $n \geq 0$, there is a finite cover $\check{Y}_i = \check{S}_i \times I$ of $Y_i = S_i \times I$, having the following properties:

- (1) $\partial_p \check{Y}_i^- = \partial \check{S}_i^- \times I$ has the same number of components as $\partial_p Y_i^- = \partial S_i^- \times I$;
- (2) the map $g_i: J_i^- \rightarrow Y_i^-$ lifts to an embedding $\check{g}_i: J_i^- \rightarrow \check{Y}_i^-$;
- (3) the points $\check{g}_i(b_{i,1,1}), \dots, \check{g}_i(b_{i,n_i,d_i})$ are evenly spaced; ie there is an integer $N_i > n$ such that each of the $n_i d_i$ components of $\partial \check{S}_i^- \setminus \{\check{g}_i(b_{i,1,1}), \dots, \check{g}_i(b_{i,n_i,d_i})\}$ has wrapping number equal to the integer N_i .

11 Adjusting the wrapping numbers

In this section we prove [Proposition 10.3](#).

Recall from [Section 7](#) that \hat{J}_i is a connected, compact, convex, hyperbolic 3-manifold obtained from J_i^- by capping off each component of $\partial_p J_i^-$ with a compact, convex 3-ball, and that $\pi_1(J_i, b_{i,1,1}) = \pi_1(J_i^-, b_{i,1,1}) = \pi_1(\hat{J}_i, b_{i,1,1})$. Also, \hat{J}_i is a submanifold of $C_n(J_i^-)$, so by [Lemma 4.2](#), $\pi_1(\hat{J}_i, b_{i,1,1})$ can be considered as a subgroup of $\pi_1(C_n(J_i^-), b_{i,1,1})$.

By [Proposition 4.7](#) there is a set of elements $y_{i,1}, \dots, y_{i,r_i}$ in $\Gamma_i - g_i^*(\pi_1(\hat{J}_i, b_{i,1,1}))$ such that, if G_i is a finite index subgroup of Γ_i which separates $g_i^*(\pi_1(\hat{J}_i, b_{i,1,1}))$

from $y_{i,1}, \dots, y_{i,r_i}$, then the local isometry $g_i: \widehat{J}_i \rightarrow Y_i$ lifts to an embedding \check{g}_i in the finite cover \check{Y}_i corresponding to G_i .

To prove [Proposition 10.3](#), we shall construct a finite index subgroup G_i of Γ_i , of sufficiently large index m_i , such that:

- (i) $m_i = N_i d_i + 1$ for some integer $N_i > n$;
- (ii) G_i contains the elements $w_{i,1}^*, \dots, w_{i,\ell_i}^*$ (defined in [Section 10](#)), and thus contains the subgroup $g_i^*(\pi_1(\widehat{J}_i, b_{i,1,1}))$;
- (iii) G_i contains the elements $z_{i,j,k}(N_i)^*$, $j = 1, \dots, n_i$, $k = 1, \dots, d_i - 1$;
- (iv) G_i does not contain any of $x_{i,j}^l$, $j = 1, \dots, n_i$, and $l = 1, \dots, m_i - 1$;
- (v) G_i does not contain any of $y_{i,1}, \dots, y_{i,r_i}$.

Proposition 11.1 *Assuming such a subgroup G_i can be found, then the corresponding finite cover $\check{Y}_i = X_i/G_i$ of Y_i will satisfy all the properties given in [Proposition 10.3](#).*

Proof Suppose that $\check{q}_i: X_i \rightarrow \check{Y}_i$ and $\check{p}_i: \check{Y}_i \rightarrow Y_i$ are the covering maps. Properties (ii) and (v) imply that the map $g_i: (\widehat{J}_i, b_{i,1,1}) \rightarrow (Y_i, t_{i,1,1})$ lifts to an embedding $\check{g}_i: (\widehat{J}_i, b_{i,1,1}) \rightarrow (\check{Y}_i, \check{q}_i(\tilde{b}))$. By our choice for the cusp C of M (which determines the cusp region \mathcal{C}_i for Y_i), the restriction of \check{g}_i on J_i^- gives a proper embedding $\check{g}_i: (J_i^-, \partial J_i^-) \rightarrow (\check{Y}_i^-, \partial \check{Y}_i^-)$, ie we have (2) of [Proposition 10.3](#).

We claim that condition (iv) implies $\partial_p \check{Y}_i^-$ has the same number of components as $\partial_p Y_i^-$, ie we have (1) of [Proposition 10.3](#). To see this, recall that each of $x_{i,j}$, $j = 1, \dots, n_i$, has a representative loop ([Figure 16](#)) which is homotopic, with the base point $t_{i,1,1}$ fixed, to an embedded loop, $x''_{i,j}$, in S_i^- , such that $x''_{i,j}$ is parallel to $\beta_{i,j}$ in S_i^- . Since G_i does not contain any of the elements $x_{i,j}^l$, $j = 1, \dots, n_i$, $l = 1, \dots, m_i - 1$, then $\check{p}_i^{-1}(x''_{i,j})$ is a single, embedded loop in \check{S}_i^- for each fixed $j = 1, \dots, n_i$. Hence $\check{p}_i^{-1}(\beta_{i,j})$ is a single component of $\partial \check{S}_i^-$ for each $j = 1, \dots, n_i$. This proves the claim.

We now show that condition (i) and (iii) imply (3) of [Proposition 10.3](#). Namely we want to show that the set of points $\check{g}_i(b_{i,1,1}), \dots, \check{g}_i(b_{i,n_i,d_i})$ are evenly spaced in $\partial \check{S}_i^-$ so that each of the $n_i d_i$ components of $\partial \check{S}_i^- \setminus \{\check{g}_i(b_{i,1,1}), \dots, \check{g}_i(b_{i,n_i,d_i})\}$ has wrapping number equal to N_i .

Consider the manifold $C_{N_i}(J_i^-)$. As noted in the previous section, the subgroup

$$g_{i,N_i}^*(\pi_1(C_{N_i}(J_i^-), b_{i,1,1})) \subset \Gamma_i$$

is generated by the elements $w_{i,1}^*, \dots, w_{i,\ell_i}^*$ and $z_{i,j,k}(N_i)^*$, $j = 1, \dots, n_i, k = 1, \dots, d_i - 1$. Hence the group $g_{i,N_i}^*(\pi_1(C_{N_i}(J_i^-), b_{i,1,1}))$ is contained in G_i by conditions (ii) and (iii). Therefore the map $g_i: (C_{N_i}(J_i^-), b_{i,1,1}) \rightarrow (Y_i, t_{i,1,1})$ lifts to a map $\check{g}_i: (C_{N_i}(J_i^-), b_{i,1,1}) \rightarrow (\check{Y}_i, \check{q}_i(\check{b}))$, ie $\check{p}_i \circ \check{g}_i = g_i$.

Let $\check{\beta}_{i,j}$ be the component of $\partial\check{S}_i^-$ which covers $\beta_{i,j}$, $j = 1, \dots, n_i$. Then by (1) and condition (i), $\check{p}_i: \check{\beta}_{i,j} \rightarrow \beta_{i,j}$ is an $N_i d_i + 1$ -fold cyclic covering, for each $j = 1, \dots, n_i$. For each fixed $j = 1, \dots, n_i$, the set of points $\{\check{g}_{i,N_i}(b_{i,j,k}), k = 1, \dots, d_i\}$ divides $\check{\beta}_{i,j}$ into d_i segments.

Recall the notations established in Section 10. Consider the multi-handle $H_{i,j}^{N_i} \subset C_{N_i}(J_i^-)$ containing the points $b_{i,j,1}, \dots, b_{i,j,d_i}$, and the geodesic arcs $\delta_{i,j,k}(N_i) \subset H_{i,j}^{N_i}$, $k = 1, \dots, d_i - 1$. By our construction the immersed arc $g_{i,N_i}: \delta_{i,j,k}(N_i) \rightarrow S_i$ is homotopic, with end points fixed, to the arc in $\beta_{i,j}$ which starts at the point $t_{i,j,k}$, wraps N_i times around $\beta_{i,j}$ and then continues to the point $t_{i,j,k+1}$, following the orientation of $\beta_{i,j}$. This latter (immersed) arc lifts to an embedded arc in $\check{\beta}_{i,j}$ connecting $\check{g}_{i,N_i}(b_{i,j,k})$ and $\check{g}_{i,N_i}(b_{i,j,k+1})$, since $\check{\beta}_{i,j}$ is an $N_i d_i + 1$ -fold cyclic cover of $\beta_{i,j}$. Now it is easy to see that the conclusion of (3) follows. \square

To find the required subgroup G_i of Γ_i , we apply again the graph technique used in Section 9. We shall use terminologies established there without recalling them again. From now on all elements of Γ_i will be considered as words in letters from $L_i \cup L_i^{-1}$, where

$$L_i = \{a_{i,1}, b_{i,1}, \dots, a_{i,g_i}, b_{i,g_i}, x_{i,1}, \dots, x_{i,n_i-1}\}$$

is the free basis of Γ_i given in Section 10. For simplicity a word w in letters of $L_i \cup L_i^{-1}$ shall also be considered as a path in a L_i -labeled directed graph, and the context will make it clear which is meant.

From Section 9 we know that to find the required subgroup G_i of Γ_i , it suffices to find a finite, connected, L_i -labeled, directed graph \mathcal{G}_i (with a fixed base vertex $v_{i,0}$) with the following properties:

- (0) \mathcal{G}_i is L_i -regular;
- (1) $m_i = N_i d_i + 1$ for some integer $N_i > n$, where m_i is the number of vertices of \mathcal{G}_i ;
- (2) each of the words $w_{i,1}^*, \dots, w_{i,\ell_i}^*$ is representable by a loop, based at $v_{i,0}$, in \mathcal{G}_i ;
- (3) \mathcal{G}_i contains a closed loop, based at $v_{i,0}$, representing the word $z_{i,j,k}(N_i)^*$, for each $j = 1, \dots, n_i, k = 1, \dots, d_i - 1$;

- (4) \mathcal{G}_i contains no loop representing the word $x_{i,j}^l$ for any $j = 1, \dots, n_i$ and $l = 1, \dots, m_i - 1$;
- (5) each of the words $y_{i,1}, \dots, y_{i,r_i}$ is representable by a non-closed path, based at $v_{i,0}$, in \mathcal{G}_i .

If such a graph can be found, then the subgroup of Γ_i represented by $L(\mathcal{G}_i, v_{i,0})$ will satisfy all the requirements (i)-(v) set for G_i . Indeed, Properties (0) and (1) of \mathcal{G}_i imply Property (i) of G_i (Lemma 9.3), and Properties (2)-(5) of \mathcal{G}_i imply Properties (ii)-(v) of G_i respectively. The task of the rest of this section is to construct such a graph \mathcal{G}_i .

If \mathcal{G} is an L_i -labeled directed graph, then \mathcal{G}^f will denote the folded graph resulting from folding \mathcal{G} (see Kapovich and Myasnikov [11] for the folding operation). Note that if \mathcal{G} is an L_i -labeled directed graph, and \mathcal{G}' is a graph obtained from \mathcal{G} by performing some folding operations on \mathcal{G} , then there is a uniquely associated quotient map $q: \mathcal{G} \rightarrow \mathcal{G}'$. In particular there is a uniquely associated quotient map from \mathcal{G} to \mathcal{G}^f .

Let n be a large integer such that the manifold $C_n(J_i^-)$ is convex, for each of $i = 1, 2$. Hence the local isometry $g_i: C_n(J_i^-) \rightarrow Y_i$ induces an injective homomorphism $g_i^*: \pi_1(C_n(J_i^-), b_{i,1,1}) \rightarrow \pi_1(Y_i, t_{i,1,1})$.

Recall that the subgroup $g_i^*(\pi_1(C_n(J_i^-), b_{i,1,1})) \subset \Gamma_i$ is generated by the elements

$$w_{i,1}^*, \dots, w_{i,\ell_i}^*, z_{i,j,k}(n)^*, 1 \leq j \leq n_i, 1 \leq k \leq d_i - 1.$$

Let $\mathcal{G}_{i,0}(n)$ be the connected, finite, L_i -labeled, directed graph which results from taking a disjoint union of embedded loops, representing the reduced versions of the words

$$w_{i,1}^*, \dots, w_{i,\ell_i}^*, z_{i,j,k}(n)^*, 1 \leq j \leq n_i, 1 \leq k \leq d_i - 1$$

respectively, and non-closed embedded paths, representing the reduced versions of the words

$$y_{i,1}, \dots, y_{i,r_i}$$

respectively, and then identifying their base vertices (their initial vertices) to a common vertex $v_{i,0}$.

Then obviously $L(\mathcal{G}_{i,0}(n), v_{i,0}) = L(\mathcal{G}_{i,0}(n)^f, v_{i,0}) = g_i^*(\pi_1(C_n(J_i^-), b_{i,1,1}))$.

We may consider a graph \mathcal{G} as metric space, by making each edge isometric to the interval $[0, 1]$, and taking the induced path metric. If $x \in \mathcal{G}$ and $s \in \mathbb{R}$, then $N_s(x)$ denotes the s -neighborhood of x in \mathcal{G} .

Lemma 11.2 *There is an integer $s > 0$, independent of n , such that, when n is large, the natural quotient map $f: \mathcal{G}_{i,0}(n) \rightarrow \mathcal{G}_{i,0}(n)^f$ is an embedding on $\mathcal{G}_{i,0} \setminus N_s(v_{i,0})$, and each of $f(y_{i,1}), \dots, f(y_{i,r_i})$ is still a non-closed path in $\mathcal{G}_{i,0}(n)^f$.*

Proof We give an explicit construction of $\mathcal{G}_{i,0}(n)^f$, building it in steps.

Let $\mathcal{G}_{i,1}$ be the connected, finite, L_i -labeled, directed graph which results from taking a disjoint union of embedded loops—representing the reduced versions of the words $w_{i,1}^*, \dots, w_{i,\ell_i}^*$ respectively—and non-closed embedded paths—representing the reduced versions of the words $y_{i,1}, \dots, y_{i,r_i}$ respectively—and then identifying their base points to a common vertex $v_{i,0}$. Then obviously $L(\mathcal{G}_{i,1}, v_{i,0})$ represents the subgroup $g_i^*(\pi_1(J_i^-, b_{i,1,1})) \subset \Gamma_i$. Since the folding operation does not change the group that the graph represents, $L(\mathcal{G}_{i,1}^f, v_{i,0}) = g_i^*(\pi_1(J_i^-, b_{i,1,1}))$. By assumption, none of the elements $y_{i,1}, \dots, y_{i,r_i}$ belong to the subgroup $g_i^*(\pi_1(J_i^-, b_{i,1,1}))$, so $y_{i,1}, \dots, y_{i,r_i}$ are still non-closed paths in $\mathcal{G}_{i,1}^f$ based at $v_{i,0}$.

Recall from [Lemma 10.1](#) that

$$z_{i,j,k}(n)^* = (\overline{\sigma_{i,j,k-1}} \cdots \overline{\sigma_{i,j,0}})(x'_{i,j})^n(\sigma_{i,j,0} \cdots \sigma_{i,j,k})$$

for $k = 1, \dots, d_i - 1$, where $\sigma_{i,j,k}$ and $x'_{i,j}$ were defined in Section 8. Note that $x'_{i,j}$ is conjugate to $x_{i,j}$ in Γ_i . Let $\tau_{i,j}$ be an element of Γ_i such that $x'_{i,j} = \tau_{i,j} x_{i,j} \tau_{i,j}^{-1}$. Let $\mathcal{G}_{i,2}$ be the connected graph which results from taking the disjoint union of $\mathcal{G}_{i,1}^f$ and non-closed embedded paths representing the reduced version of the words $\overline{\sigma_{i,j,k-1}} \cdots \overline{\sigma_{i,j,0}} \tau_{i,j}$, $1 \leq j \leq n_i$, $1 \leq k \leq d_i$, respectively, and then identifying their base vertices into a single base vertex which we still denote by $v_{i,0}$. Then obviously we have $L(\mathcal{G}_{i,2}^f, v_{i,0}) = L(\mathcal{G}_{i,2}, v_{i,0}) = L(\mathcal{G}_{i,1}^f, v_{i,0}) = g_i^*(\pi_1(J_i^-, b_{i,1,1}))$.

Let $v_{i,j,k}$ be the terminal vertex of the path $\overline{\sigma_{i,j,k-1}} \cdots \overline{\sigma_{i,j,0}} \tau_{i,j}$ in $\mathcal{G}_{i,2}^f$, for each $j = 1, \dots, n_i$ and $k = 1, \dots, d_i$. For each $j = 1, \dots, n_i - 1$ (when $n_i > 1$) and $k = 1, \dots, d_i$, let $q_{i,j,k}$ be the maximal $x_{i,j}$ -path in $\widehat{\mathcal{G}_{i,2}^f}$ (a maximal $x_{i,j}$ -path was defined in [Section 9](#)) which contains the vertex $v_{i,j,k}$. For $j = n_i$, and each $k = 1, \dots, d_i$, let $q_{i,n_i,k}$ be the maximal x_{i,n_i} -path in $\widehat{\mathcal{G}_{i,2}^f}$ determined by:

- (1) if there is a directed edge of $\widehat{\mathcal{G}_{i,2}^f}$ with $v_{i,j,k}$ as its initial vertex and with the first letter of the word x_{i,n_i} as its label, then $q_{i,n_i,k}$ contains that edge;
- (2) if the edge described in (1) does not exist, then $v_{i,j,k}$ is the terminal vertex of $q_{i,n_i,k}$ and the first letter of the word x_{i,n_i} is the terminal missing label of $q_{i,n_i,k}$.

Note that each $q_{i,j,k}$ is uniquely determined. Also no $q_{i,j,k}$ can be an $x_{i,j}$ -loop, since the group $L(\mathcal{G}_{i,2}^f, v_{i,0}) = g_i^*(\pi_1(J_i^-, b_{i,1,1}))$ does not contain non-trivial peripheral elements of Γ_i . Let $v_{i,j,k}^-$ and $v_{i,j,k}^+$ be the initial and terminal vertices of $q_{i,j,k}$ respectively. Note that if $j < n_i$ and $q_{i,j,k}$ is not a constant path, then $v_{i,j,k}^-$ and $v_{i,j,k}^+$

must be distinct vertices; however $v_{i,n_i,k}^-$ and $v_{i,n_i,k}^+$ may possibly be the same vertex, even if $q_{i,j,k}$ is a non-constant path.

For each $j = 1, \dots, n_i$ and $k = 1, \dots, d_i$, let $q_{i,j,k}^-$ be the embedded subpath of $q_{i,j,k}$ with $v_{i,j,k}^-$ as the initial vertex and with $v_{i,j,k}$ as the terminal vertex, and let $q_{i,j,k}^+$ be the embedded subpath of $q_{i,j,k}$ with $v_{i,j,k}$ as the initial vertex and with $v_{i,j,k}^+$ as the terminal vertex.

Note that the set $\{\text{Length}(q_{i,j,k}) : i = 1, 2, j = 1, \dots, n_i, k = 1, \dots, d_i\}$ is independent of n , and thus is bounded. So we may assume that for each $i = 1, 2$,

$$n > 10 + \max\{2\text{Length}(q_{i,j,k}) : i = 1, 2, j = 1, \dots, n_i, k = 1, \dots, d_i\}.$$

Now for each $j = 1, \dots, n_i$ and $k = 1, \dots, d_i - 1$, we make a new non-closed embedded path $\Theta_{i,j,k}(n)$ representing the word $x_{i,j}^n$, and we add it to the graph $\mathcal{G}_{i,2}^f$, by identifying the initial vertex of $\Theta_{i,j,k}(n)$ with $v_{i,j,k}$ and the terminal vertex with $v_{i,j,k+1}$. In the resulting graph there are some obvious places one can perform the folding operation: for each $j = 1, \dots, n_i$ and $k = 1, \dots, d_i - 1$, the path $q_{i,j,k}^+$ can be completely folded into the added new path $\Theta_{i,j,k}(n)$, and likewise the path $q_{i,j,k+1}^-$ can be completely folded into $\Theta_{i,j,k}(n)$. Let $\mathcal{G}_{i,3}(n)$ be the resulting graph after performing these specific folding operations for each $j = 1, \dots, n_i$ and $k = 1, \dots, d_i - 1$.

From the explicit construction, it is clear that $\mathcal{G}_{i,3}(n)$ has the following properties:

- (1) $\mathcal{G}_{i,3}(n)$ is a connected, finite, L_i -labeled, directed graph;
- (2) $\mathcal{G}_{i,3}(n)$ contains loops, based at $v_{i,0}$, representing the word $z_{i,j,k}(n)^*$ for each $j = 1, \dots, n_i, k = 1, \dots, d_i - 1$;
- (3) $\mathcal{G}_{i,3}(n)$ contains $\mathcal{G}_{i,2}^f$ as an embedded subgraph;
- (4) $\mathcal{G}_{i,3}(n)$ is obtained from $\mathcal{G}_{i,0}(n)$ by a sequence of folds.

It follows from Property (3) that the paths in $\mathcal{G}_{i,2}^f$ representing the words $y_{i,1}, \dots, y_{i,r_i}$ remain each non-closed in $\mathcal{G}_{i,3}(n)$, and it follows from Property (4) that:

$$L(\mathcal{G}_{i,3}(n), v_{i,0}) = L(\mathcal{G}_{i,0}(n), v_{i,0}) = g_i^*(\pi_1(C_n(J_i^-), b_{i,1,1})).$$

So $\widehat{\mathcal{G}_{i,3}(n)}$ cannot have $x_{i,j}$ -loops for any j .

Now we consider the remaining folding operations on $\mathcal{G}_{i,3}(n)$ that need to be done, in order to get the folded graph $\mathcal{G}_{i,3}(n)^f$.

For each $j = 1, \dots, n_i$ and $k = 1, \dots, d_i - 1$, let $\Theta_{i,j,k}(n)' = \Theta_{i,j,k}(n) \setminus (q_{i,j,k}^+ \cup q_{i,j,k+1}^-)$. Then by our construction each $\Theta_{i,j,k}(n)'$ is an embedded $x_{i,j}$ -path with

$v_{i,j,k}^+$ as its initial vertex and with $v_{i,j,k+1}^-$ as the terminal vertex, and contains a subpath representing the word $x_{i,j}^{10}$. Also all these paths $\Theta_{i,j,k}(n)'$, $j = 1, \dots, n_i$ and $k = 1, \dots, d_i - 1$, are mutually disjoint in their interior, and their disjoint union is equal to $\mathcal{G}_{i,3}(n) \setminus \mathcal{G}_{i,2}^f$.

For each fixed $j = 1, \dots, n_i$, there is an $x_{i,j}$ -path in $\mathcal{G}_{i,3}(n)$ with $v_{i,j,1}^-$ as the initial vertex and with v_{i,j,d_i}^+ as the terminal vertex, containing all the vertices $v_{i,j,k}^\pm$, $k = 1, \dots, d_i$, and containing all the paths $\Theta_{i,j,k}(n)$, $k = 1, \dots, d_i - 1$. Since $\widehat{\mathcal{G}_{i,3}(n)}$ has no $x_{i,j}$ -loops, we see immediately that when $j < n_i$, all the vertices $v_{i,j,k}^\pm$, $k = 1, \dots, d_i$, are mutually distinct.

We know that:

- (1) each vertex $v_{i,j,k}^\pm$ is a initial or terminal vertex of a maximal $x_{i,j}$ -path in $\mathcal{G}_{i,2}^f$;
- (2) the graph $\mathcal{G}_{i,2}^f$ is an embedded, folded subgraph of $\mathcal{G}_{i,3}(n)$;
- (3) each $\Theta_{i,j,k}(n)'$ is an embedded path in $\mathcal{G}_{i,3}(n)$;
- (4) for each fixed $j < n_i$, all the vertices $v_{i,j,k}^\pm$, $k = 1, \dots, d_i$, are mutually distinct.

It follows that the only remaining folds are at the vertices $v_{i,n_i,k}^\pm$, where possibly a single edge from $\Theta_{i,n_i,k}(n)'$ may be folded to a single edge from $\Theta_{i,j,k_*}(n)'$, for some $1 \leq j < n_i$ and some $1 \leq k_* \leq d_i - 1$. At such a vertex there is at most one edge from $\Theta_{i,n_i,k}(n)'$ which may be folded with one $x_{i,j}$ -edge of $\Theta_{i,j,k_*}(n)'$. Thus $\mathcal{G}_{i,3}(n)^f$ is obtained from $\mathcal{G}_{i,3}(n)$ by performing at most $2d_i$ folds (which occur at some of the vertices $v_{i,n_i,k}^\pm$, $k = 1, \dots, d_i$), and every non-closed, reduced path in $\mathcal{G}_{i,3}(n)$ which is based at $v_{i,0}$ will remain non-closed in $\mathcal{G}_{i,3}(n)^f$. In particular, the paths representing the words $y_{i,1}, \dots, y_{i,r_i}$ are each non-closed in $\mathcal{G}_{i,3}(n)^f = \mathcal{G}_{i,0}(n)^f$.

Let $f_3: \mathcal{G}_{i,3}(n) \rightarrow \mathcal{G}_{i,3}(n)^f$ be the natural map. Then by the construction, we see that if s_1 is greater than $2d_i + \text{Diameter}(\mathcal{G}_{i,2}^f)$, then the map $f_3: \mathcal{G}_{i,3}(n) \rightarrow \mathcal{G}_{i,3}(n)^f$ is an embedding on $\mathcal{G}_{i,3}(n) - N_{s_1}(v_{i,0})$. Since $\mathcal{G}_{i,3}(n)$ is a partial folding of $\mathcal{G}_{i,0}(n)$, there is a quotient map $g: \mathcal{G}_{i,0}(n) \rightarrow \mathcal{G}_{i,3}(n)$. Letting s be the diameter of $g^{-1}(N_{s_1}(v_{i,0}))$, then g is an embedding on $\mathcal{G}_{i,0}(n) - N_s(v_{i,0})$. Since the map $f: \mathcal{G}_{i,0}(n) \rightarrow \mathcal{G}_{i,0}(n)^f = \mathcal{G}_{i,3}(n)^f$ is the composition of the maps g and f_3 , we see that f is an embedding on $\mathcal{G}_{i,0} - N_s(v_{i,0})$. Obviously the number s is independent of n . The proof of [Lemma 11.2](#) is now complete. \square

Let s be the constant integer guaranteed by [Lemma 11.2](#). We may assume that s is large enough so that $N_s(v_{i,0})$ in $\mathcal{G}_{i,0}(n)$ contains the loops $w_{i,1}^*, \dots, w_{i,\ell_i}^*$, the paths y_1, \dots, y_{r_i} and the paths representing the words $\overline{\sigma_{i,j,k-1}} \cdots \overline{\sigma_{i,j,0}} \tau_{i,j}$, $j = 1, \dots, n_i$,

$k = 1, \dots, d_i - 1$. (The choice of s given in the proof of Lemma 11.2 actually already satisfies this requirement.) We may assume further that n is large enough so that the components of $\mathcal{G}_{i,0}(n)^f \setminus f(N_{v_{i,0}}(s))$ can be denoted by $\Phi_{i,j,k}(n)$, $1 \leq j \leq n_i$, $1 \leq k \leq d_i - 1$, such that $\Phi_{i,j,k}(n)$ is an embedded subpath in $\Theta_{i,j,k}(n)'$ (and thus is a $x_{i,j}$ -path) containing a sufficiently large power of $x_{i,j}$. This is clearly possible from the proof of Lemma 11.2.

The next step is to modify the graph $\mathcal{G}_{i,0}(n)^f$, by inserting copies of a certain graph Ω , pictured in Figure 17, and then performing folding operations, to obtain a graph (the graph $\mathcal{G}_{i,4}(n)$ given below) which contains loops, based at the base vertex $v_{i,0}$, representing the words

$$w_{i,1}^*, \dots, w_{i,\ell_i}^*, z_{i,j,k}(n+1)^*, 1 \leq j \leq n_i, 1 \leq k \leq d_i - 1,$$

respectively, and which contains non-closed paths, based at $v_{i,0}$, representing the words

$$y_{i,1}, \dots, y_{i,r_i}$$

respectively. Then from this graph we can go two steps further to find the required graph (The graph $\mathcal{G}_{i,6}(n)$ given afterwards). The method for constructing $\mathcal{G}_{i,4}(n)$ breaks into three cases, ie

- (a) when n_i is even,
- (b) when $n_i > 1$ is odd, and
- (c) when $n_i = 1$.

In Figure 17, single edge loops at a vertex have one label each from the labels $L_i^* = \{a_{i,1}, b_{i,1}, \dots, a_{i,g_i}, b_{i,g_i}\}$. The edges in part (a) and (b) connecting two adjacent vertices are $x_{i,j}$ -edges, $j = 1, 2, \dots, n_i - 1$, (precisely $n_i - 1$ edges). In part (a) of the figure, an $x_{i,j}$ -edge points from the left vertex to the right vertex iff j is odd, and in part (b) of the figure, an $x_{i,j}$ -edge points from left to right iff j is 1 or an even number. The edges in part (c) connecting the left two vertices and pointing from left to right are labeled $a_{i,j}$ and $b_{i,j}$, $j = 1, 2, \dots, g_i$, respectively, while the edges connecting the left two vertices but pointing from right to left are labeled $b_{i,1}, a_{i,j}, b_{i,j}$, $j = 2, \dots, g_i$, respectively. The right half of (c) is an identical copy of the left half of (c).

Case (a) n_i is even.

We shall insert $d_i - 1$ copies of the graph Ω (Figure 17 part (a)), denoted $\Omega_k, k = 1, \dots, d_i - 1$, as follows. For each $1 \leq k \leq d_i - 1$, we define a subset of vertices $\mathcal{U}_{i,k} = \{u_{i,j,k} : 1 \leq j \leq n_i\} \subset \mathcal{G}_{i,0}(n)^f$ where,

- if $j \leq n_i - 1$, then $u_{i,j,k}$ is a vertex in $\Phi_{i,j,k}(n)$, such that there are at least three

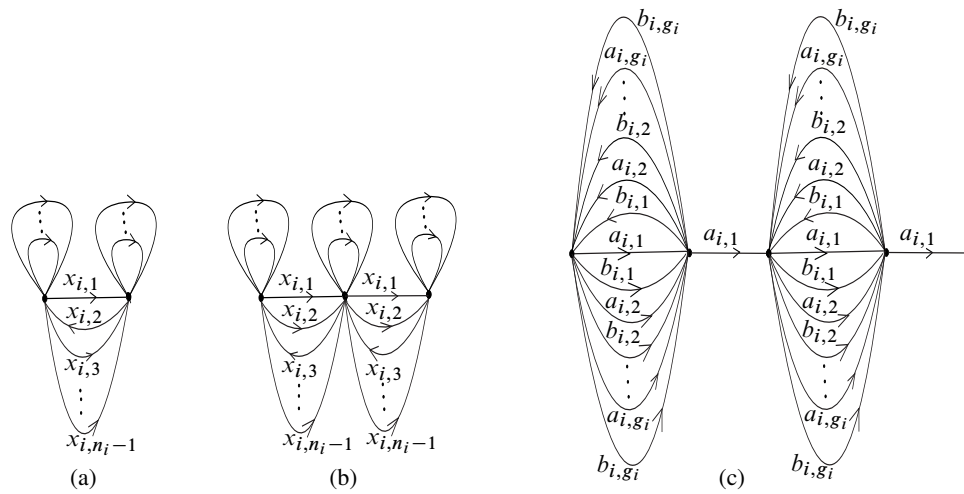

Figure 17: The graph Ω when: (a) n_i is even (b) $n_i > 1$ is odd (c) $n_i = 1$

edges before it and after it in the directed (and thereby ordered) path $\Phi_{i,j,k}(n)$, and $u_{i,n_i,k}$ is the initial vertex of an edge labeled x_1 in $\Phi_{i,n_i,k}(n)$ such that there are at least three edges with label x_1 before it and after it in the path $\Phi_{i,n_i,k}(n)$.

Then cut $\mathcal{G}_{i,0}(n)^f$ at the vertices of $\mathcal{U}_{i,k}$, $k = 1, \dots, d_i - 1$, and for each k , insert the graph Ω_k , which is a copy of the graph Ω shown in Figure 17 (a). That is, we:

(1) Form a cut graph $\mathcal{G}_{i,0}(n)^f_c = \mathcal{G}_{i,0}(n)^f \setminus \{\mathcal{U}_{i,k}; k = 1, \dots, d_i - 1\}$, whose vertex set is obtained from the vertex set of $\mathcal{G}_{i,0}(n)^f$ by replacing each $u_{i,j,k} \in \mathcal{U}_{i,k}$ with a pair of vertices $u_{i,j,k}^\pm$. More precisely the point $u_{i,j,k}$ cuts the path $\Phi_{i,j,k}$ into two components; $u_{i,j,k}^+$ is the terminal vertex of one component, and $u_{i,j,k}^-$ is the initial vertex of the other component. If each pair $\{u_{i,j,k}^+, u_{i,j,k}^-\}$ is identified into a single vertex, then the resulting graph is $\mathcal{G}_{i,0}(n)^f$.

(2) For each fixed $k = 1, \dots, d_i - 1$, we identify the vertex set $\{u_{i,j,k}^\pm, j = 1, \dots, n_i\}$ of $\mathcal{G}_{i,0}(n)^f_c$ with the vertices of Ω_k as follows:

- if $j < n_i$, identify $u_{i,j,k}^+$ with the left vertex of Ω_k if j is odd and to the right vertex if j is even, and identify $u_{i,j,k}^-$ with the right vertex of Ω_k if j is odd and to the left vertex if j is even;
- identify $u_{i,n_i,k}^+$ with the left vertex of Ω_k and identify $u_{i,n_i,k}^-$ with the right vertex of Ω_k .

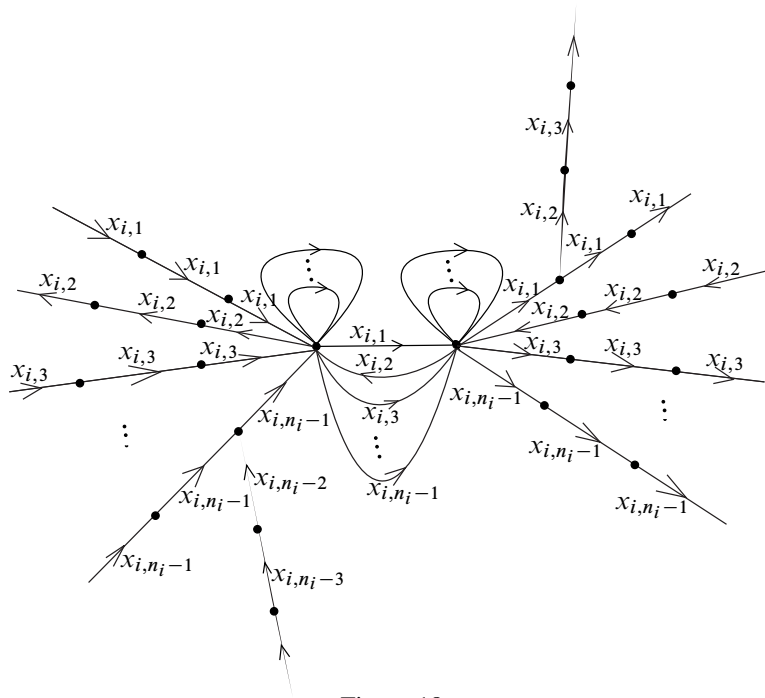

Figure 18

The resulting graph is not folded, but becomes folded graph after the following obvious folding operation around each inserted Ω_k :

- fold the subpath $x_{i,n_i-1}a_{i,1}b_{i,1}a_{i,1}^{-1}b_{i,1}^{-1}\cdots a_{i,g_i}b_{i,g_i}a_{i,g_i}^{-1}b_{i,g_i}^{-1}$ whose terminal vertex is the vertex $u_{i,n_i,k}^+$ with the loops of Ω_k at the left vertex of Ω_k and then with the x_{i,n_i-1} -edge of $\mathcal{G}_{i,4}(n)$ whose terminal vertex is the left vertex of Ω_k , and
- fold the two x_1 -edges whose initial vertices are the right vertex of Ω_k .

The resulting folded graph $\mathcal{G}_{i,4}(n)$ around the inserted Ω_k is shown in Figure 18. By our construction we see that $\mathcal{G}_{i,4}(n)$ is a folded, L_i -labeled, directed graph, with no $x_{i,j}$ -loops, with each of the words $w_{i,1}^*, \dots, w_{i,\ell_i}^*$ still representable by a loop based at $v_{i,0}$, and with each of the words $y_{i,1}, \dots, y_{i,r_i}$ still representable by a non-closed path based at $v_{i,0}$. Also we see that the graph $\mathcal{G}_{i,4}(n)$ contains loops based $v_{i,0}$ representing the words $z_{i,j,k}(n+1)^*$, for any $j = 1, \dots, n_i, k = 1, \dots, d_i - 1$.

The graph $\mathcal{G}_{i,4}(n)$ is not L_i -regular yet since it does not contain any $x_{i,j}$ -loops. So it must contain a missing label. Let $x \in L_i$ be a missing label at a vertex v of $\mathcal{G}_{i,4}(n)$. Let α be a finite directed graph consisting of a single path of edges all labeled with x , as shown in Figure 19. We identify the left end vertex of α to the vertex v of $\mathcal{G}_{i,4}(n)$. The resulting graph $\mathcal{G}_{i,5}(n)$ is obviously still folded, contains $\mathcal{G}_{i,4}(n)$ as an embedded subgraph, and contains no $x_{i,j}$ -loops for any $j = 1, \dots, n_i$. By choosing a

long enough path α , we may assume that the number of vertices of $\mathcal{G}_{i,5}(n)$ is bigger than $d_i(n+1)+1$.



Figure 19

Now by [Remark 9.7](#), we can obtain an L_i -regular graph $\mathcal{G}_{i,6}(n)$ such that

- (1) $\mathcal{G}_{i,5}(n)$ is an embedded subgraph of $\mathcal{G}_{i,6}(n)$; thus in particular in $\mathcal{G}_{i,6}(n)$ each of the words $w_{i,1}^*, \dots, w_{i,\ell_i}^*$, $z_{i,j,k}(n+1)^*$, $j = 1, \dots, n_i$, $k = 1, \dots, d_i - 1$ is representable by a loop based at $v_{i,0}$, and each of the words $y_{i,1}, \dots, y_{i,r_i}$ is representable by a non-closed path based at $v_{i,0}$;
- (2) $\mathcal{G}_{i,6}(n)$ contains no loops representing the word $x_{i,j}^l$ for any $j = 1, \dots, n_i$, $l = 1, \dots, m_i^* - 1$, where m_i^* is the number of vertices of $\mathcal{G}_{i,6}(n)$.

Note that m_i^* is some integer larger than $d_i(n+1)+1$. Let $N_i = m_i^* - (d_i - 1)(n+1) - 1$. Then $N_i > (n+1)$.

During the transformation from $\mathcal{G}_{i,4}(n)$ to $\mathcal{G}_{i,6}(n)$, the subgraph of $\mathcal{G}_{i,4}(n)$ consisting of the edges which intersect the subgraph Ω_k (for each fixed $k = 1, \dots, d_i - 1$) remained unchanged since $\mathcal{G}_{i,4}(n)$ was locally L_i -regular already at the two vertices of Ω_k . Now we replace Ω_k , for each of $k = 1, \dots, d_i - 1$, by a graph similar to Ω but with $N_i - n + 1 \geq 3$ vertices ([Figure 20](#) illustrates such a graph with four vertices). Then the resulting graph $\mathcal{G}_{i,7}(n)$ has the following properties.

- (1) $\mathcal{G}_{i,7}(n)$ is L_i -regular;
- (2) each of the words $y_{i,1}, \dots, y_{i,r_i}$ is still representable by a non-closed path based at $v_{i,0}$ in $\mathcal{G}_{i,7}(n)$;
- (3) each of the words $w_{i,1}^*, \dots, w_{i,\ell_i}^*$ is still representable by a loop based at $v_{i,0}$ in $\mathcal{G}_{i,7}(n)$;
- (4) $\mathcal{G}_{i,7}(n)$ contains no loops representing the word $x_{i,j}^l$ for each $j = 1, \dots, n_i$ and each $l = 1, \dots, m_i - 1$, where m_i is the number of vertices of $\mathcal{G}_{i,7}$;
- (5) $\mathcal{G}_{i,7}(n)$ contains a closed loop based at $v_{i,0}$ representing the word $z_{i,j,k}(N_i)^*$, for each $j = 1, \dots, n_i$; $k = 1, \dots, d_i - 1$; and
- (6) m_i , the number of vertices of $\mathcal{G}_{i,7}(n)$, is equal to $N_i d_i + 1$.

Properties (1)-(5) are obvious by the construction, while property (6) follows by a simple calculation. Indeed

$$\begin{aligned}
 m_i &= m_i^* + (N_i - n + 1 - 2)(d_i - 1) \\
 &= [N_i + (d_i - 1)(n + 1) + 1] + (N_i - (n + 1))(d_i - 1) \\
 &= N_i d_i + 1.
 \end{aligned}$$

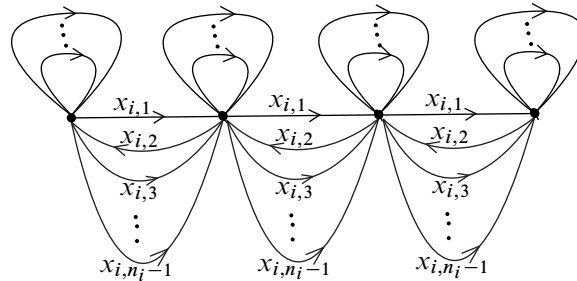

Figure 20

Case (b) $n_i > 1$ is odd

We modify the graph $\mathcal{G}_{i,0}(n)^f$ as follows. For each of $k = 1, \dots, d_i - 1$, we define a subset of vertices $\mathcal{U}_{i,k} = \{u_{i,j,k} : 1 \leq j \leq n_i\} \cup \{u'_{i,n_i,k}\} \subset \mathcal{G}_{i,0}(n)^f$, where

- if $j \leq n_i - 1$, then $u_{i,j,k}$ is a vertex in $\Phi_{i,j,k}(n)$, such that there are at least three edges after it and at least three edges before it in the directed path $\Phi_{i,j,k}(n)$;
- $u_{i,n_i,k}$ is the initial vertex of an edge labeled x_1 in $\Phi_{i,n_i,k}(n)$ such that there are at least three edges with label x_1 before it in the directed path $\Phi_{i,j,k}(n)$; and
- $u'_{i,n_i,k}$ is the initial vertex of an edge with label x_2 in $\Phi_{i,j,k}(n)$ which appears after the vertex $u_{i,j,k}$ in the directed path $\Phi_{i,j,k}$. We also insist that $\Phi_{i,j,k}(n)$ contains at least three edges with label x_1 between $u_{i,n_i,k}$ and $u'_{i,n_i,k}$ and at least three edges with label x_1 after $u'_{i,n_i,k}$.

Then cut $\mathcal{G}_{i,0}(n)^f$ at the vertices of $\mathcal{U}_{i,k}$, $k = 1, \dots, d_i - 1$, and for each k , insert the graph Ω_k , which is a copy of the graph Ω shown in Figure 17 (b). That is, we do the following:

- (1) Form a cut graph $\mathcal{G}_{i,0}(n)^f_c = \mathcal{G}_{i,0}(n)^f \setminus \{\mathcal{U}_{i,k}; k = 1, \dots, d_i - 1\}$, defined as in Case (a), with obvious modifications, ie we have similarly defined pairs of vertices $u_{i,j,k}^\pm, u'_{i,n_i,k}^\pm$ for $\mathcal{G}_{i,0}(n)^f_c$ such that if each such \pm pair of vertices are identified, then the resulting graph is the original $\mathcal{G}_{i,0}(n)^f$.
- (2) For each fixed $k = 1, \dots, d_i - 1$, we identify the vertex set $\{u_{i,j,k}^\pm, u'_{i,n_i,k}^\pm, j = 1, \dots, n_i\}$ of $\mathcal{G}_{i,0}(n)^f_c$ with the left and right-most vertices of Ω_k as follows:

- if $j < n_i$, and $j = 1$ or j is even, then identify $u_{i,j,k}^+$ with the left-most vertex of Ω_k and $u_{i,j,k}^-$ with the right-most vertex;
- if $j < n_i$, $j \neq 1$ and j is odd, then identify $u_{i,j,k}^+$ with the right-most vertex of Ω_k and $u_{i,j,k}^-$ with the left-most vertex;
- identify $u_{i,n_i,k}^+$ with the left-most vertex of Ω_k and identify $u_{i,n_i,k}^-$ with the right-most vertex of Ω_k ;
- identify $u_{i,n_i,k}'^+$ with the left-most vertex of Ω_k and identify $u_{i,n_i,k}'^-$ with the right-most vertex of Ω_k .

The resulting graph is not folded, but becomes folded graph after the following folding operations are performed around each inserted Ω_k :

- fold the path $x_{i,n_i-1}a_{i,1}b_{i,1}a_{i,1}^{-1}b_{i,1}^{-1} \cdots a_{i,g_i}b_{i,g_i}a_{i,g_i}^{-1}b_{i,g_i}^{-1}$ whose terminal vertex is the vertex $u_{i,n_i,k}^+$ with the loops of Ω_k at the left-most vertex of Ω_k and then with the x_{i,n_i-1} -edge of $\mathcal{G}_{i,4}(n)$ whose terminal vertex is the left-most vertex of Ω_k ;
- fold the two $x_{i,1}$ -edges whose initial vertices are the right-most vertex of Ω_k ;
- fold the two $x_{i,1}$ -edges whose terminal vertices are the left-most vertex of Ω_k ;
- fold the two $x_{i,2}$ -edges whose initial vertices are the right-most vertex of Ω_k .

The resulting folded graph $\mathcal{G}_{i,4}(n)_0^f$ around the inserted Ω_k is shown in [Figure 21](#). By our construction we see that $\mathcal{G}_{i,4}(n)^f$ is a folded, L_i -labeled, directed graph, with no $x_{i,j}$ -loops, with each of the words $w_{i,1}^*, \dots, w_{i,\ell_i}^*$ still representable by a loop based at $v_{i,0}$, and with each of the words $y_{i,1}, \dots, y_{i,r_i}$ still representable by a non-closed path based at $v_{i,0}$. Also we see that the graph $\mathcal{G}_{i,4}(n)$ contains loops based $v_{i,0}$ representing the words $z_{i,j,k}(n+2)^*$, for all $j = 1, \dots, n_i$, $k = 1, \dots, d_i - 1$.

We then define $\mathcal{G}_{i,5}(n)$ and $\mathcal{G}_{i,6}(n)$ in a similar manner as Case (a); here we may assume that $\mathcal{G}_{i,5}(n)$ has at least $(d_i - 1)(n + 2) - 1$ vertices. Let m_i^* be the number of vertices of $\mathcal{G}_{i,6}$, and let $N_i = m_i^* - (d_i - 1)(n + 2) - 1$. To form $\mathcal{G}_{i,7}(n)$, we replace each graph Ω_k , $k = 1, \dots, d_i - 1$ in $\mathcal{G}_{i,6}(n)$ with a graph similar to [Figure 17\(b\)](#) but with $1 + N_i - n$ vertices. In the current case, we need $1 + N_i - n$ to be an odd integer in order for the construction to work. ([Figure 22](#) illustrates such a graph with five vertices). This is made possible by the following lemma.

Lemma 11.3 $N_i - n$ is even.

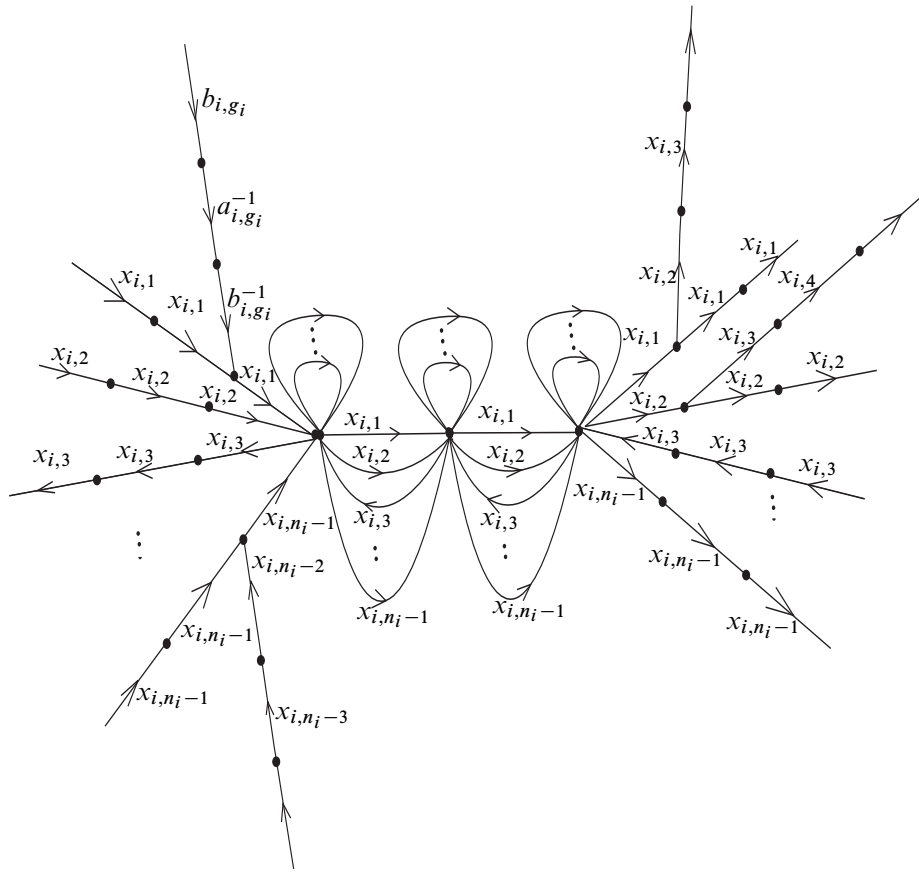

Figure 21

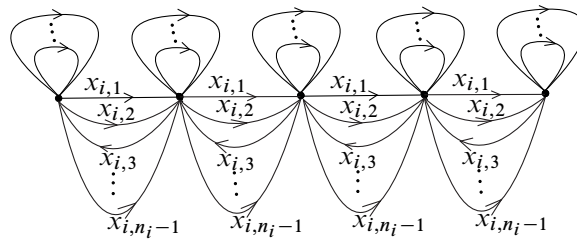

Figure 22

Proof Since n_i is odd, then the Euler characteristic $\chi(S_i^-)$ of S_i^- is odd. Let \widehat{S}_i^- be the cover of S_i^- corresponding to the subgroup $L(\mathcal{G}_{i,6}(n), v_{i,0})$ of Γ_i . Due to the property (2) of the graph $\mathcal{G}_{i,6}$, \widehat{S}_i^- also has n_i boundary components (cf the second paragraph in the proof of Proposition 11.1). So $\chi(\widehat{S}_i^-)$ is also odd. Therefore the degree

of the cover, which is m_i^* , must be odd. We have that $m_i^* = N_i + (d_i - 1)(n + 2) + 1$. Since n_i is odd, n_{i^*} is even (see Section 5). Thus $d_i - 1 = \Delta n_{i^*} - 1$ is odd. Thus N_i and n are both even or both odd. So $N_i - n$ is even. \square

The rest of the argument proceeds by obvious analogy with the case where n_i is even. That is, the graph $\mathcal{G}_{i,7}(n)$ is a graph with the properties listed as (1)–(6) in Case (a). Indeed, Properties (1)–(5) are immediate. To verify Property (6), we let m_i be the number of vertices of $\mathcal{G}_{i,7}$, and then we have:

$$\begin{aligned} m_i &= m_i^* + (1 + N_i - n - 3)(d_i - 1) \\ &= N_i + (d_i - 1)(n + 2) + 1 + (N_i - n - 2)(d_i - 1) \\ &= N_i d_i + 1 \end{aligned}$$

Case (c) $n_i = 1$

We modify the graph $\mathcal{G}_{i,0}(n)^f$ as follows. For each of $k = 1, \dots, d_i - 1$, we pick a pair vertices $\{u_{i,k}, u'_{i,k}\}$ in $\Phi_{i,1,k}$ as follows:

– $u_{i,k}$ is the terminal vertex of an edge with label $a_{i,1}$ in $\Phi_{i,j,k}(n)$ such that there are at least three edges with label $a_{i,1}$ before $u_{i,k}$ in the directed path $\Phi_{i,j,k}(n)$; and
 – $u'_{i,k}$ is the terminal vertex of an edge with label $b_{i,1}$ which appears after the vertex $u_{i,k}$. We also insist that there are at least three edges with label $b_{i,1}$ between $u_{i,k}$ and $u'_{i,k}$ and that there are at least three edges with label $b_{i,1}$ after $u'_{i,k}$ in the path $\Phi_{i,j,k}(n)$.

Then cut the graph $\mathcal{G}_{i,0}(n)^f$ at all the pairs of vertices $\{u_{i,k}, u'_{i,k}\}$, $k = 1, \dots, d_i - 1$, and for each k , insert the graph Ω_k – which is a copy of the graph Ω shown in Figure 17 (c) – as follows. Form a cut graph $\mathcal{G}_{i,0}(n)^f_c = \mathcal{G}_{i,0}(n)^f \setminus \{u_{i,k}, u'_{i,k}; k = 1, \dots, d_i - 1\}$, and let $u_{i,k}^\pm, u'_{i,k}^\pm$ be the corresponding vertices for $\mathcal{G}_{i,0}(n)^f_c$. For each fixed $k = 1, \dots, d_i - 1$, we identify the vertex $u_{i,k}^+$ with the left-most vertex of Ω_k , identify $u_{i,k}^-$ with the right-most vertex of Ω_k , identify $u'_{i,k}^+$ with the right-most vertex of Ω_k and identify $u'_{i,k}^-$ with the left-most vertex of Ω_k .

The resulting graph is not folded, but becomes folded graph after a single folding operation around each inserted Ω_k : fold the two $a_{i,1}$ –edges whose terminal vertices are the right-most vertex of Ω_k . The resulting folded graph $\mathcal{G}_{i,4}(n)_0^f$ around the inserted Ω_k is shown in Figure 23. By our construction we see that $\mathcal{G}_{i,4}(n)^f$ is a folded L_i –labeled directed graph, with no $x_{i,1}$ –loops, with each of the words $w_{i,1}^*, \dots, w_{i,\ell_i}^*$ still representable by a loop based at $v_{i,0}$, and with each of the words $y_{i,1}, \dots, y_{i,r_i}$ still representable by a non-closed path based at $v_{i,0}$. Also we see that

the graph $\mathcal{G}_{i,4}(n)$ contains loops based at $v_{i,0}$ representing the words $z_{i,1,k}(n+4)^*$, for all $k = 1, \dots, d_i - 1$.

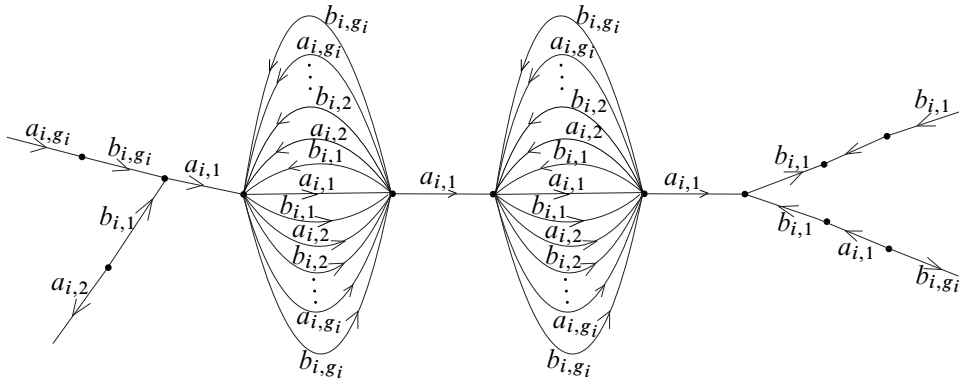

Figure 23

As in the previous case, we get $\mathcal{G}_{i,5}(n)$ and $\mathcal{G}_{i,6}(n)$. In the current case, $N_i = m_i^* - (d_i - 1)(n + 4) - 1$, which is assumed larger than $n + 4$ (since m_i^* can be assumed arbitrary large). To form $\mathcal{G}_{i,7}(n)$, we replace the left half (with three vertices) of Ω_k , for each $k = 1, \dots, d_i - 1$, with a graph similar to Figure 17(c) but with $N_i - n - 1$ vertices. In the current case, we also need $1 + N_i - n$ to be an odd integer in order for the construction to work. This is true, and can be proved as in Case (b). It is easy to see that $\mathcal{G}_{i,7}(n)$ has all the Properties (1)–(5). To verify Property (6), we have:

$$\begin{aligned} m_i &= m_i^* + (N_i - n - 1 - 3)(d_i - 1) \\ &= N_i + (d_i - 1)(n + 4) + 1 + (N_i - n - 4)(d_i - 1) \\ &= N_i d_i + 1 \end{aligned}$$

12 HS-manifolds

We call a compact, connected, orientable 3-manifold W with boundary is an HS-manifold if it has the form $W = H \cup (S \times I)$, where:

- (i) each component of H is a handlebody of genus at least one;
- (ii) each component of S is a compact orientable surface with boundary;
- (iii) $H \cap (S \times I) = \partial S \times I$;
- (iv) each component of $H \cap (S \times I) = \partial S \times I$ is an annulus in ∂H which is homotopically non-trivial in H .

Lemma 12.1 *Let $W = H \cup (S \times I)$ be an HS–manifold. Let A denote the set of annuli $H \cap (S \times I) = \partial S \times I$. Suppose that S has no disk components, and that for every compressing disk D of H , the set $D \cap A$ has at least two components. Then W has incompressible boundary.*

Proof Suppose otherwise that ∂W is compressible in W . Let $(B, \partial B) \subset (W, \partial W)$ be a compressing disk. Isotope B so that it intersects the set of annuli A in a collection of properly embedded arcs and simple closed curves. Since no component of S is a disk, and since each component of A is non-trivial in H , we can remove, by isotopy of B , all simple closed curve components of $B \cap A$ (by a standard inner-most argument, using also the fact that H and $S \times I$ are irreducible 3–manifolds).

Note that the intersection $A \cap B$ cannot be empty since otherwise B would be contained in $S \times I - A$ but each component of $\partial(S \times I) - A$ is incompressible in $S \times I$.

We may also assume that each arc component of $A \cap B$ is essential in A . For otherwise we can surger the disk B along an outer-most such arc in A to get a compressing disk of W whose intersection with A has fewer components.

Now $B \cap A$ is a set of arcs, each of which is essential in A . Let α be a component of $B \cap A$ which is outer-most in B . Let β be the component of $\partial B \setminus \partial\alpha$ whose interior is disjoint from A , and let B_1 be the sub-disk of B co-bounded by α and β . Then $B_1 \cap A = \partial B_1 \cap A = \alpha$, and thus if B_1 is contained in H , then it must be an essential compressing disk in H . But by our assumption no such compressing disk exists. On the other hand, there is no properly embedded disk in $S \times I$ which intersects $\partial S \times I$ in a single essential arc. \square

13 Proof of Theorem 1.1

In Section 11, we found, for each $i = 1, 2$, a finite cover $\check{Y}_i = \check{S}_i \times I$ of $Y_i = S_i \times I$, such that the map $g_i: J_i^- \rightarrow Y_i^-$ lifts to an embedding $\check{g}_i: J_i^- \rightarrow \check{Y}_i^-$, and the d components of $\check{g}_i(\partial_p J_i^-)$ are evenly spaced in $\partial_p \check{Y}_i^-$, far apart from each other in $\partial_p \check{Y}_i^-$. Recall from Section 6 that K_i is an embedded submanifold of J_i with an R –collared neighborhood in J_i , and that $(K_i^-, \partial_p K_i^-)$ is properly embedded in the pair $(J_i^-, \partial_p J_i^-)$, with a relative R –collared neighborhood. It follows that the pair $(\check{g}_i(K_i^-), \check{g}_i(\partial_p K_i^-))$ has a relative R –collared neighborhood in $(\check{Y}_i^-, \partial_p \check{Y}_i^-)$.

Also recall from Section 6 that K_1^- and K_2^- are isometric under the isometry $h: K_1^- \rightarrow K_2^-$. Thus there is a corresponding isometry from $\check{g}_1(K_1^-)$ to $\check{g}_2(K_2^-)$, which is $\check{g}_2 \circ h \circ \check{g}_1^{-1}$.

Now let \check{Y}^- be the union of \check{Y}_1^- and \check{Y}_2^- with $\check{g}_1(K_1^-)$ and $\check{g}_2(K_2^-)$ identified by the isometry. Let $U_k^- \subset \check{Y}^-$ be the identification of $\check{g}_1(K_{1,k}^-)$ with $\check{g}_2(K_{2,k}^-)$, $k = 1, \dots, q$, and let U^- be the disjoint union of U_k^- 's. Then \check{Y}^- is a connected metric space, with a path metric induced from the metrics on Y_1^- and Y_2^- . There is an induced local isometry $f: \check{Y}^- \rightarrow M$.

Define the parabolic boundary, $\partial_p \check{Y}^-$, of \check{Y}^- to be the union of $\partial_p \check{Y}_1^-$ and $\partial_p \check{Y}_2^-$, with $\check{g}_1(\partial_p K_1)$ and $\check{g}_2(\partial_p K_2)$ identified by the isometry $\check{g}_2 \circ h \circ \check{g}_1^{-1}$. The parabolic boundary of U^- is defined to be the identification of $\check{g}_1(\partial_p K_1)$ and $\check{g}_2(\partial_p K_2)$. Let D_j , $j = 1, \dots, d$, be the components of the parabolic boundary $\partial_p U^-$ of U^- , and let s_j be the topological center point of D_j (ie the s_j 's are the intersection points of $\partial \check{S}_1^-$ and $\partial \check{S}_2^-$ in $\partial_p \check{Y}^-$). Since $\check{g}_i(K_i^-)$ has an R -collared neighborhood in \check{Y}_i^- , then U^- has an R -collared neighborhood in \check{Y}^- .

Recall $f_i: (S_i^-, \partial S_i^-) \rightarrow (M^-, \partial M^-)$ is a proper map, such that $f_i|_{\partial S_i^-}: \partial S_i^- \rightarrow \partial M$ is an embedding for each $i = 1, 2$. Let $\beta_{i,j}^* = f_i(\beta_{i,j})$. Then Δ is the intersection number between $\beta_{1,1}^*$ and $\beta_{2,1}^*$, and t_1, \dots, t_d are the $d = n_1 n_2 \Delta$ intersection points between $\{\beta_{1,j}^*, j = 1, \dots, n_1\}$ and $\{\beta_{2,j}^*, j = 1, \dots, n_2\}$ (since each $\beta_{i,j}^*$ is a Euclidean circle in the Euclidean torus ∂M^-). Recall also that $\check{\beta}_{i,j}$, $j = 1, \dots, n_i$, are boundary components of $\partial \check{S}_i^-$, and each $\check{\beta}_{i,j}$ is the cyclic covering of $\beta_{i,j}$ of order $m_i = N_i d_i + 1$. Recall that by our convention, t_1 is the base point for each of M , M^- , C and $T = \partial M = \partial C$, and that t_1 is one of intersection points between $\beta_{1,1}^*$ and $\beta_{2,1}^*$. We may consider $\beta_{1,1}^*$ and $\beta_{2,1}^*$ as two elements in $\pi_1(T, t_1) = \pi_1(C, t_1)$. Now let \mathcal{A} be the subgroup of $\pi_1(T, t_1)$ generated by the two elements $(\beta_{1,1}^*)^{m_1}$ and $(\beta_{2,1}^*)^{m_2}$. Then \mathcal{A} is a rank two subgroup of $\pi_1(T, t_1) = \pi_1(C, t_1)$ of finite index. Let $p_0: \check{C} \rightarrow C$ be the covering corresponding to \mathcal{A} . By our construction, $\partial_p \check{Y}^-$ can be embedded isometrically in $\check{T} = \partial \check{C}$ such that $p_0: \check{\beta}_{i,j} \rightarrow \beta_{i,j}^*$ is the map $\check{\beta}_{i,j} \rightarrow \beta_{i,j} \rightarrow \beta_{i,j}^*$ for each $j = 1, \dots, n_i$. Thus the geometric intersection number in \check{T} between $\check{\beta}_{1,1}$ and $\check{\beta}_{2,1}$ is equal to Δ and there are $d = n_1 n_2 \Delta$ intersection points $\{s_k, k = 1, \dots, d\}$ between $\{\check{\beta}_{1,j}, j = 1, \dots, n_1\}$ and $\{\check{\beta}_{2,j}, j = 1, \dots, n_2\}$. We may assume that the s_k 's are indexed so that $p_0(s_k) = t_k$, $k = 1, \dots, d$. From the construction of Section 11, the points $\{s_k, k = 1, \dots, d\}$ divide the circles $\{\check{\beta}_{i,j}, j = 1, \dots, n_i\}$ into segments, each of which has wrapping number N_i . Thus $\{\check{\beta}_{i,j}, i = 1, 2, j = 1, \dots, n_i\}$ divides the torus \check{T} into a set of Euclidean parallelograms with long sides (because the wrapping numbers N_1 and N_2 can be chosen arbitrarily large).

We now replace the R -collared neighborhood of U^- in \check{Y}^- by a hyperbolic 3-manifold \bar{U}^- , whose construction is given below, such that:

- (i) \bar{U}^- is a thickening of U^- ;

- (ii) the new space $Y^- = \check{Y}_1^- \cup \bar{U}^- \cup \check{Y}_2^-$ is a connected, compact, hyperbolic 3-manifold, locally convex everywhere except on its parabolic boundary, whose metric restricts to the original metric on \check{Y}^- ;
- (iii) Y^- has a local isometry $f: Y^- \rightarrow M$ which extends the local isometries $f_i \circ \check{p}_i: \check{Y}_i^- \rightarrow M$;
- (iv) the parabolic boundary of Y^- is a regular neighborhood of that of \check{Y}^- in the torus \check{T} and thus the complement of $\partial_p(Y^-)$ in \check{T} is a set of “round-cornered parallelograms” in \check{T} (cf Figure 25);
- (v) since each such parallelogram given in (iv) has very long sides, we can cap off $\partial_p Y^-$ with a solid cusp C_0 ; the resulting manifold Y is a convex, hyperbolic 3-manifold with a cusp and Y has a local isometry into M .

We now provide more details. First we construct \bar{U}^- , component-wise. We illustrate the construction of \bar{U}_k^- for the component U_k^- of U^- . Recall the construction of $K_{i,k}$ given in Section 6. It is the quotient space of $Z_{i,j_k} \subset X_i$ under the group Γ_{i,j_k} . Recall that $\check{q}_i: X_i \rightarrow \check{Y}_i$ is the universal covering map. Thus Z_{i,j_k}^- is the universal cover of $\check{q}_i(K_{i,k}^-)$ under the map \check{q}_i . Also there are elements $\gamma_{i,j_k} \in \Gamma$ such that $X_{i,j_k} = \gamma_{i,j_k}(X_i)$, $W_{j_k} = X_{1,j_k} \cap X_{2,j_k}$, and $Z_{i,j_k} = \gamma_{i,j_k}^{-1}(W_{j_k})$. The space W_{j_k} is invariant under the action of the group $\gamma_{1,j_k} \Gamma_1 \gamma_{1,j_k}^{-1} \cap \gamma_{2,j_k} \Gamma_2 \gamma_{2,j_k}^{-1}$.

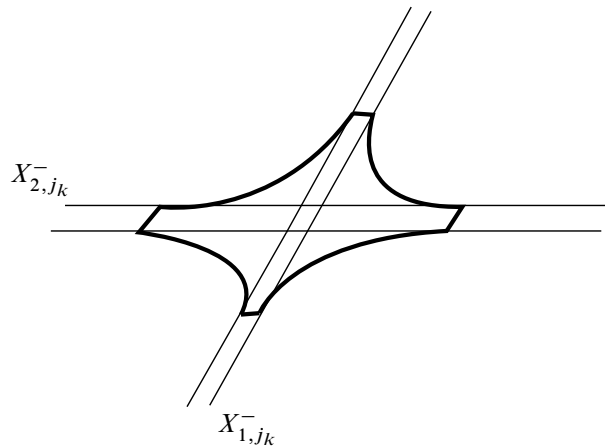

Figure 24: The plane region enclosed in the thickened curve is the component of the parabolic boundary of $\bar{W}_{j_k}^-$ in ∂B_∞ .

Now let $\text{Hull}(X_{1,j_k} \cup X_{2,j_k})$ be the convex hull of $X_{1,j_k} \cup X_{2,j_k}$ in \mathbb{H}^3 , and let $N_R(W_{j_k})$ be the R -collared neighborhood of W_{j_k} in \mathbb{H}^3 . Then $\text{Hull}(X_{1,j_k} \cup X_{2,j_k}) -$

$(X_{1,j_k} \cup X_{2,j_k}) \subset N_R(W_{j_k})$ by Proposition 4.5. Let $\bar{W}_{j_k} = N_R(W_{j_k}) \cap \text{Hull}(X_{1,j_k} \cup X_{2,j_k})$, and $\bar{W}_{j_k}^- = \bar{W}_{j_k} \setminus \mathcal{B}$. We call $\bar{W}_{j_k}^- \cap \mathcal{B}$ the parabolic boundary of \bar{W}_{j_k} . Note that $\bar{W}_{j_k}^-$ is invariant under the action of $\gamma_{1,j_k} \Gamma_1 \gamma_{1,j_k}^{-1} \cap \gamma_{2,j_k} \Gamma_2 \gamma_{2,j_k}^{-1}$. The component of the parabolic boundary of $\bar{W}_{j_k}^-$ in ∂B_∞ is as shown in Figure 24. Let $\bar{U}_k^- = \bar{W}_{j_k}^- / (\gamma_{1,j_k} \Gamma_1 \gamma_{1,j_k}^{-1} \cap \gamma_{2,j_k} \Gamma_2 \gamma_{2,j_k}^{-1})$. We now replace the R -collared neighborhood of U_k^- in \check{Y}^- by \bar{U}_k^- ; that is, we glue $\check{Y}^- \setminus N_{(R,\check{Y}^-)}(U_k^-)$ with \bar{U}_k^- along the frontier of $N_{(R,\check{Y}^-)}(U_k^-)$ in \check{Y}^- (which is a part of the boundary of \bar{U}_k^-), using the original gluing map $\check{g}_2 \circ h \circ \check{g}_1^{-1}$. We do this operation for each component of U^- . Because U^- has an R -collared neighborhood in \check{Y}^- , the components \bar{U}_k^- do not interfere with each other. That is, if we let Y^- denote the resulting space, then \bar{U}_k^- , $k = 1, \dots, q$, are mutually disjoint from each other in Y^- . Let \bar{U}^- be the union of \bar{U}_k^- , $k = 1, \dots, q$.

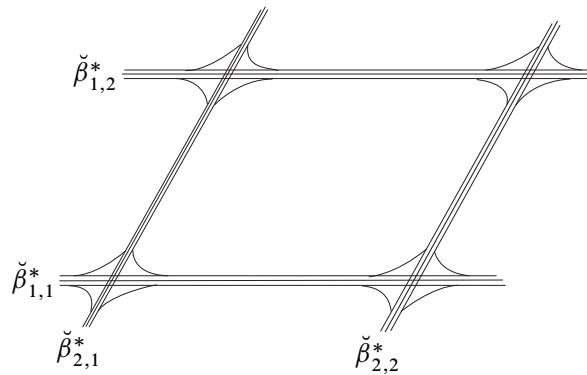

Figure 25: The parabolic boundary of Y^-

Lemma 13.1 Y^- is a connected, compact, hyperbolic 3-manifold containing \check{Y}_i^- , $i = 1, 2$, as submanifolds (with their original hyperbolic structures), and there is a local isometry $f: Y^- \rightarrow M^-$ extending the maps $f_i \circ \check{p}_i: \check{Y}_i^- \rightarrow M^-$.

Proof By Corollary 6.9, the frontier of $N_{(R,\check{Y}_i^-)}(K_i^-)$ in \check{Y}_i^- is a set of (truncated) strips and annuli (the latter set may be empty) for each $i = 1, 2$. Note that the frontier of $N_{(R,\check{Y}^-)}(U_k^-)$ in \check{Y}^- is the disjoint union of the frontier of $N_{(R,\check{Y}_i^-)}(K_i^-)$ in \check{Y}_i^- , $i = 1, 2$. Hence \check{Y}^- is obtained from gluing two 3-manifolds along subsurfaces in their boundaries and thus is a manifold. Obviously it is a connected and compact 3-manifold. We just need to show that the hyperbolic structures of the gluing pieces match up over the identified region, forming a global hyperbolic structure on Y^- .

It is enough to verify this around each component of \bar{U}^- . From the construction of \bar{U}_k^- given above, we see that $X_{1,j_k}^- \cup \bar{W}_{j_k}^- \cup X_{2,j_k}^-$ is a hyperbolic 3-submanifold of \mathbb{H}^3 . Also X_{i,j_k}^- is a universal cover of \check{Y}_i^- , $i = 1, 2$, and $\bar{W}_{j_k}^-$ is a universal cover of \bar{U}_k^- , so there is a natural map from $X_{1,j_k}^- \cup \bar{W}_{j_k}^- \cup X_{2,j_k}^-$ to the manifold $\check{Y}_1^- \cup \bar{U}_k^- \cup \check{Y}_2^-$. This provides the required hyperbolic structure around the component U_k^- .

Finally, the map f can be constructed by piecing together the maps $f_i \circ \check{p}_i$, and then extending to Y^- in the obvious way. \square

Lemma 13.2 *Each component of \bar{U}^- is a handlebody.*

Proof Each component \bar{U}_k^- of \bar{U}^- is homeomorphic to $K_{i,k}^-$, and thus is compact and irreducible. Since the fundamental group of \bar{U}_k^- is isomorphic to a subgroup of the free group Γ_i , then \bar{U}_k^- is a handlebody. \square

The parabolic boundary $\partial_p Y^-$ of Y^- in \check{T} is the union of the parabolic boundary of \check{Y}_i^- , $i = 1, 2$, and that of \bar{U}^- (see Figure 25).

Now we are going to construct the cusp C_0 mentioned in (v) above. The horosphere ∂B_∞ is a universal cover of \check{T} . Let $p_*: \partial B_\infty \rightarrow \check{T}$ be the covering map. Along each component of $p_*^{-1}(\{\check{\beta}_{i,j}, i = 1, 2, j = 1, \dots, n_i\})$ we place an appropriate translation of X_i by an element of Γ , and at each point of $p_*^{-1}(\{s_1, \dots, s_d\})$ we place an appropriate translation of a component of $\{\bar{W}_{j_1}, \dots, \bar{W}_{j_q}\}$ by an element of Γ . Let Q denote the union of these manifolds.

Let B_∞^0 be the horoball based at ∞ which is smaller than B_∞ by distance one, ie the horizontal plane ∂B_∞^0 is above ∂B_∞ by distance one. Let V_0 be the region between the two horizontal planes ∂B_∞^0 and ∂B_∞ , and let $Q_0 = Q \cap V_0$. Let \tilde{C}_0 be the convex hull of Q_0 in \mathbb{H}^3 . Then obviously \tilde{C}_0 is contained in B_∞ .

Lemma 13.3 *If n (and thus $N_i > n$) is large enough, then $\tilde{C}_0 \cap V_0 = Q_0$.*

Proof Consider the frontier of Q_0 in V_0 . It is a set of infinitely many annuli. Let A_1 be one of them. Then every point x in A_1 is a point in the boundary of some translation of X_i or in the boundary of some translation of $\{\bar{W}_1, \dots, \bar{W}_q\}$. The tangent plane P_x of that manifold at x (a geodesic plane) is not a vertical plane and thus its intersection with the horizontal plane ∂B_∞^0 is a Euclidean circle of finite diameter d_x . Modulo the action of $\beta_{1,1}^*$ and $\beta_{2,1}^*$, the set $\{d_x, x \in A_1\}$ has an upper bound independent of the integer n . Also modulo the action of the abelian group $\mathcal{A} = \langle (\beta_{1,1}^*)^{m_1}, (\beta_{2,1}^*)^{m_2} \rangle$, there are only finitely many different annuli in $Fr_{V_0}(Q_0)$. Hence the set $\{d_x, x \in Fr_{V_0}(Q_0)\}$

has an upper bound independent of the integer n . Therefore if n is sufficiently large, each P_x , $x \in FrV_0(Q_0)$, will only intersect Q_0 at x . Thus in forming the convex hull of Q_0 , all the new points added are above the plane ∂B_∞^0 . (cf Figure 26). The lemma is proved. \square

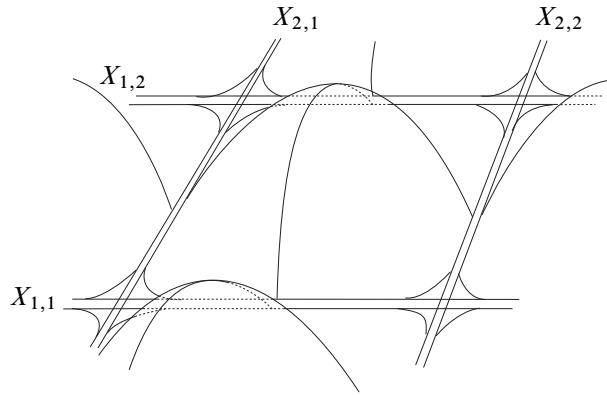

Figure 26: The convex hull above the plane ∂B_∞^0

We may assume that $N_i > n$ has been chosen big enough so that the conclusion of Lemma 13.3 holds.

By our construction, Q_0 is invariant under the action of the abelian group $\mathcal{A} = \langle (\beta_{1,1}^*)^{m_1}, (\beta_{2,1}^*)^{m_2} \rangle$, and so is \tilde{C}_0 . Now let $C_0 = \tilde{C}_0/\mathcal{A}$. Then C_0 is contained in the cusp \tilde{C} and $C_0 \cap \tilde{T} = \partial_p Y^-$. Let Y be the manifold which is the union of Y^- and C_0 glued along the parabolic boundary of Y^- . We use the obvious gluing map, which is locally consistent with the gluing of Q and \tilde{C}_0 in \mathbb{H}^3 . As in the proof of Lemma 13.1, one can show that Y is a hyperbolic manifold with a local isometry f into M . Moreover Y is also convex. Indeed, we only need to check local convexity in a small neighborhood of $\partial_p Y^-$ in Y , which holds, since the model space $Q \cup \tilde{C}_0$ is locally convex in a small neighborhood of \tilde{C}_0 in $Q \cup \tilde{C}_0$.

Thus the local isometry f induces an injection of $\pi_1(Y, s_1)$ into $\pi_1(M, t_1)$. We shall show:

Proposition 13.4 *If Δ is bigger than one, or if both of n_1 and n_2 are bigger than one, then:*

- (1) *the boundary of Y is incompressible in Y ;*
- (2) *no essential loop in ∂Y is freely homotopic into C_0 .*

To prove [Proposition 13.4](#), it is sufficient to show that every Dehn filling of Y along its cusp C_0 gives a 3-manifold with incompressible boundary.

Let $Y(\alpha)$ be any Dehn filling of Y along C_0 with slope α . We claim that $Y(\alpha)$ is an HS-manifold (see [Section 12](#)). The handlebody part H of $Y(\alpha)$ is $\bar{U}^- \cup C_0(\alpha)$, where $C_0(\alpha)$ is the filling of the cusp C_0 with slope α . Indeed by [Lemma 13.2](#) each component of \bar{U}^- is a handlebody which connects to the solid torus $C_0(\alpha)$ along its parabolic boundary $\partial_p \bar{U}^-$ which is a set of disks. Thus $H = \bar{U}^- \cup C_0(\alpha)$ is a connected handlebody. The $S \times I$ part of $Y(\alpha)$ is $Y(\alpha) \setminus H = Y(\alpha) \setminus (\bar{U}^- \cup C_0(\alpha))$. Indeed $Y(\alpha) \setminus (\bar{U}^- \cup C_0(\alpha))$ is the union of $\check{Y}_i^- \setminus N_{(R, \check{Y}_i^-)}(\check{g}_i(K_i^-)) = \check{Y}_i^- \setminus \check{g}_i((AN_{(R, X_i)}(K_i))^-)$, $i = 1, 2$. It follows from [Corollary 6.9](#) that $\check{g}_i((AN_{(R, X_i)}(K_i))^-)$ can be considered as $F_i^- \times I$ for some compact subsurface F_i^- of \check{S}_i^- . Therefore each component of $\check{Y}_i^- \setminus N_{(R, \check{Y}_i^-)}(\check{g}_i(K_i^-))$ can be given a trivial I -bundle structure over a compact surface with boundary such that the frontier in \check{Y}_i^- consists of I -fibers (these I -fibers may not be consistent with the old I -fibers for \check{Y}_i^-). The surface S is compact, but is possibly disconnected.

Let $A = \partial S \times I$, which is the frontier of $\bigcup_{i=1,2} \check{g}_i((AN_{(R, X_i)}(K_i))^-)$ in $Y(\alpha)$ and is a set of mutually disjoint, properly embedded annuli in $Y(\alpha)$. By [Lemma 12.1](#), we only need to show that for each compressing disk D of H , $D \cap A$ has at least two components, and that each component of S is not a disk. We deal with the latter requirement first.

Lemma 13.5 *If n (and thus $N_i > n$) is sufficiently large, then S has no disk component.*

Proof It is equivalent to show that if n is sufficiently large then for each $i = 1, 2$, each component of $\check{Y}_i^- \setminus \check{g}_i((AN_{(R, X_i)}(K_i))^-)$ is not simply connected.

Suppose otherwise that $\check{Y}_i^- \setminus \check{g}_i((AN_{(R, X_i)}(K_i))^-)$ has a component E_0 which is simply connected (a 3-ball). We call the part of the boundary of E_0 which lies in $\partial_p \check{Y}_i^-$ the parabolic boundary of E_0 and denote it by $\partial_p E_0$. The union of the parabolic boundary and the frontier of E_0 in \check{Y}_i^- is an annulus A_0 in the boundary of E_0 . The annulus A_0 can be decomposed by a set of parallel, essential arcs into components which are alternately components in $Fr_{\check{Y}_i^-}(E_0)$ and $\partial_p E_0$. We call these components *frontier faces* and *parabolic faces* of A_0 , respectively. Since the frontier of $\check{g}_i((AN_{(R, X_i)}(K_i))^-)$ in \check{Y}_i^- has exactly d components ([Corollary 6.10](#)), the annulus A_0 has at most $2d$ faces. Note that every parabolic face of the annulus A_0 is a very long rectangle, depending on n , and that every frontier face of A_0 has a bounded diameter, independent of n .

The 3-ball component E_0 has a lift, \tilde{E}_0 , to X_i^- , the universal cover of \check{Y}_i^- . Note that \tilde{E}_0 is isometric to E_0 . Let \tilde{A}_0 be an annulus in the boundary of \tilde{E}_0 which is a lift of A_0 . The annulus \tilde{A}_0 has the corresponding decomposition into parabolic and frontier faces. Every parabolic face of \tilde{A}_0 is a long Euclidean rectangle contained in $\partial_p X_i^- = X_i \cap \partial \mathcal{B}_i$. Since Γ acts transitively on components of \mathcal{B} , there is an element γ of Γ such that $\gamma(\tilde{A}_0)$ has a parabolic face D_0 which lies in ∂B_∞ .

Claim $\gamma(\tilde{A}_0)$ has only one parabolic face which lies in ∂B_∞ .

Since $\gamma(\tilde{E}_0)$ is contained in $\gamma(X_i^-)$, we only need to show that $\gamma(\tilde{A}_0)$ has only one parabolic face which lies in $\partial B_\infty \cap \gamma(X_i^-)$, which is an infinite Euclidean strip between two parallel Euclidean lines. Note that every frontier face of $\gamma(\tilde{A}_0)$ separates $\gamma(X_i^-)$. It follows that if $\gamma(\tilde{A}_0)$ has at least two parabolic faces in $\gamma(X_i^-) \cap \partial B_\infty$, then there must exist a frontier face of $\gamma(\tilde{A}_0)$ with two opposite sides contained in the strip $\gamma(X_i^-) \cap \partial B_\infty$ as essential arcs. But this contradicts [Corollary 6.11](#), proving the claim.

Recall that we have assumed that every horoball component in \mathcal{B} , except B_∞ , has Euclidean diameter less than one. It follows that the Euclidean diameter of the set $\gamma(\tilde{A}_0) \setminus D_0$ is some fixed number independent of n . But the Euclidean diameter of D_0 must be very large if n is very large. Thus the annulus $\gamma(\tilde{A}_0)$ cannot exist if n is sufficiently large. The lemma follows. \square

We may assume that the number $N_i > n$ has been chosen big enough so that the surface S has no disk components.

Now for the former requirement that for each compressing disk D of H , $D \cap A$ has at least two components, it is sufficient to show that $\partial H \setminus A$ is incompressible in H (since the genus of H is obviously larger than one). We show:

Lemma 13.6 *If either both of n_1 and n_2 are bigger than one or Δ is bigger than one, then $\partial H \setminus A$ is incompressible in H .*

Proof We call $\partial \check{Y}_i^- \setminus \partial_p \check{Y}_i^-$ the *horizontal boundary* of \check{Y}_i^- . It has two components and is incompressible in \check{Y}_i^- . The boundary of \bar{U}^- can be divided into three parts: the parabolic boundary $\partial_p \bar{U}^-$, the frontier of \bar{U}^- in \check{Y}^- , and the rest which we call the *horizontal boundary* of \bar{U}^- (which we denote by $\partial_h \bar{U}^-$). [Figure 27](#) illustrates $\partial_p \bar{U}^-$; in this figure, the frontier boundary meets $\partial_p \bar{U}^-$ in straight segments, and the horizontal boundary meets $\partial_p \bar{U}^-$ in curved arcs.

Claim The horizontal boundary of \bar{U}^- is incompressible in \bar{U}^- .

Proof of Claim We just need to prove the claim for each component \bar{U}_k^- of \bar{U}^- . First note that the boundary of the I -bundle $\check{g}_i((AN_{(R,X_i)}(K_{i,k}))^-)$ can be naturally divided into parabolic, frontier and horizontal boundaries as well. Let $A_{i,k}$ be the frontier boundary of $\check{g}_i((AN_{(R,X_i)}(K_{i,k}))^-)$, and let $S'_{i,k}$ be the horizontal boundary of $\check{g}_i((AN_{(R,X_i)}(K_{i,k}))^-)$. Note that $A_{1,k} \cup A_{2,k}$ is the frontier boundary of \bar{U}_k^- and that $\partial_h \bar{U}_k^- = \partial \bar{U}_k^- \setminus (\partial_p \bar{U}_k^- \cup A_{1,k} \cup A_{2,k})$. Obviously $S'_{i,k}$ is incompressible in $\check{g}_i((AN_{(R,X_i)}(K_{i,k}))^-)$. Since each component of $S'_{i,k}$ separates \bar{U}_k^- and carries the fundamental group of \bar{U}_k^- , each component of $\partial \bar{U}_k^- \setminus (\partial_p \bar{U}_k^- \cup A_{1,k})$ is parallel in \bar{U}_k^- to a component of $S'_{i,k}$ and thus is incompressible in \bar{U}_k^- . The components of $A_{2,k}$ are all annuli and strips, and the core curve of every annulus component of $A_{2,k}$ is essential in \bar{U}_k^- . Therefore, $\partial_h \bar{U}_k^- = (\partial \bar{U}_k^- \setminus (\partial_p \bar{U}_k^- \cup A_{1,k})) \setminus A_{2,k}$ is incompressible in \bar{U}_k^- . The proof of the claim is finished.

Returning to the proof of [Lemma 13.6](#), suppose that there is a compressing disk D for H which is disjoint from the annuli A . We may assume that D is chosen to minimize the components of $D \cap \partial_p \bar{U}^-$.

If $D \cap \partial_p \bar{U}^-$ is empty, then D is contained in \bar{U}^- (it cannot be in $C_0(\alpha)$ since $\partial C_0(\alpha) \setminus \partial_p Y^-$ is a set of disks), contradicting the claim. Thus $D \cap \partial_p \bar{U}^- \neq \emptyset$. Certainly we may assume that $D \cap \partial_p \bar{U}^-$ has no circle components. Let σ be an arc component of $D \cap \partial_p \bar{U}^-$ which is outermost in D . The arc σ divides D into two disks; let D_0 be the one whose interior is disjoint from $\partial_p \bar{U}^-$. Let $\beta = \partial D_0 \cap \partial D$. Then $\partial D_0 = \sigma \cup \beta$. Let D_* be the component of $\partial_p \bar{U}^-$ which contains the arc σ .

[Figure 27](#) shows the parabolic boundary of Y^- near D_* . A pair of parallel straight lines in the figure (including the dotted line segments) is a part of a pair of circles which bounds a component of the original parabolic boundary of \check{Y}_i^- . There are two such components at D_* , one from $\partial_p \check{Y}_1^-$ and the other from $\partial_p \check{Y}_2^-$. We call the components of their intersections with ∂D_* *corners* of D_* . Alternately, the four corners are the intersection components of the annuli A with D_* .

We claim that the endpoints of σ cannot separate the four corners in ∂D_* , ie a case like that shown in [Figure 27](#) (b) or (c) is impossible. Indeed, the endpoints of σ are also the endpoints of the connected arc β whose interior is disjoint from the parabolic boundary of Y^- and the annuli A . So if a case like [Figure 27](#) (b) or (c) happens, then β cannot be contained in $\partial C_0(\alpha)$. For otherwise the geometric intersection number Δ would be one and n_1 or n_2 would be equal to one. The arc β cannot be contained in the horizontal boundary of \bar{U}^- either. For the endpoints of σ lies in different components of the horizontal boundary of \bar{U}^- .

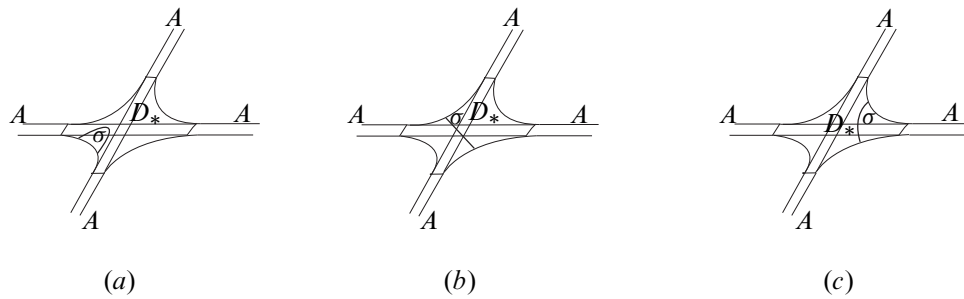

Figure 27

Hence σ is contained in D_* as shown in Figure 27 (a). Let β' be the sub-arc in ∂D_* which is disjoint from the corners of D_* and co-bounds a sub-disk D_1 in D_* with σ . Then the union of D_0 and D_1 along σ is a properly embedded disk in H which we denote by D_2 . Suppose that β is contained in $\partial C_0(\alpha)$. Then D_0 is contained in $C_0(\alpha)$. Since $\partial C_0(\alpha) \setminus \partial_p Y^-$ is a set of disks, ∂D_0 cannot be an essential curve in the torus $\partial C_0(\alpha)$. Thus ∂D_0 bounds a disk D_3 in $\partial C_0(\alpha)$. The two disks D_0 and D_3 form a 2-sphere in $C_0(\alpha)$ and thus bound a 3-ball in $C_0(\alpha)$ (since $C_0(\alpha)$ is irreducible). Now it is clear that we can isotope the part of D contained in the 3-ball to cross the sub-disk D_1 of D_* and thus reduce the number of intersection components of $D \cap \partial_p \bar{U}^-$. Suppose then that β is contained in the horizontal boundary of \bar{U}^- . Then D_0 is contained in \bar{U}^- and so is the disk D_2 . Since the horizontal boundary is incompressible, ∂D_2 is not an essential curve in the horizontal boundary, ie ∂D_2 must bound a disk D_4 in the horizontal boundary. The two disks D_2 and D_4 form a 2-sphere in \bar{U}^- and thus bound a 3-ball in \bar{U}^- (since \bar{U}^- is irreducible). Again we can isotope the part of D contained in the 3-ball to cross the sub-disk D_1 of D_* and thus reduce the number of intersection components of $D \cap \partial_p \bar{U}^-$. \square

The proof of Proposition 13.4 is finished.

We now are in position to finish the proof of Theorem 1.1. Obviously Y has non-empty boundary. Suppose Δ is bigger than one, or that both of n_1 and n_2 are bigger than one. Then we claim that $f|_{\partial Y}$ is a quasi-Fuchsian surface. Indeed, since f is injective on $\pi_1 Y$, Part (1) of Proposition 13.4 implies that f is injective in $\pi_1 \partial Y$. Since ∂Y is closed, then $f|_{\partial Y}$ is not a virtual fiber. Therefore, by the Marden–Thurston–Bonahon classification of essential surfaces (see Section 1 Introduction), it is enough to show that $f^* \pi_1 \partial Y$ contains no non-trivial parabolic elements.

The torus ∂C_0 is incompressible in Y (otherwise Y would be an open solid torus, which is obviously impossible). Hence $f^*(\pi_1(C_0, s_1))$ is a finite index subgroup of the abelian group $\pi_1(\partial C, t_1)$. Hence if α is a non-trivial loop of ∂Y , and if $f\alpha$ is

freely homotopic into C , then some non-zero power of α is freely homotopic into C_0 , contradicting [Proposition 13.4](#) Part (2).

Suppose then, that $\Delta = 1$ and one of n_1 or n_2 (say n_1) is 1. In this case we take the double cover of the manifold Y dual to the non-separating surface \check{S}_1 in Y (note that \check{S}_1 is naturally embedded in Y). Let $\hat{p}: \hat{Y} \rightarrow Y$ be the double cover. Then \hat{Y} is a convex hyperbolic 3-manifold with a single cusp, which maps by a local isometry into M . Also $\hat{p}^{-1}(\check{Y}_1^-)$ has two components, and so in particular its parabolic boundary has two components on the boundary of the cusp $\hat{C}_0 = \hat{p}^{-1}(C_0)$. Now we just need to show that every Dehn filling of \hat{Y} gives a manifold whose boundary is incompressible. Let $\hat{Y}(\alpha)$ be any Dehn filling of \hat{Y} along the cusp \hat{C}_0 with slope α . We give $\hat{Y}(\alpha)$ the obvious HS-manifold structure. Obviously the surface cross interval part of the HS-manifold has no simply connected components (since taking the double cover does not change this property). The rest of proof is exactly as that of [Proposition 13.4](#) since the parabolic boundary of $\hat{p}^{-1}(\check{Y}_i^-)$ has at least two components now for each of $i = 1, 2$. This completes the proof of [Theorem 1.1](#).

Acknowledgement The second author was partially supported by NSF grant DMS-0204428.

References

- [1] **C C Adams**, *Toroidally alternating knots and links*, *Topology* 33 (1994) 353–369 [MR1273788](#)
- [2] **C C Adams, A W Reid**, *Quasi-Fuchsian surfaces in hyperbolic knot complements*, *J. Austral. Math. Soc. Ser. A* 55 (1993) 116–131 [MR1231698](#)
- [3] **M Baker, D Cooper**, *A combination theorem for convex hyperbolic manifolds, with applications to surfaces in 3-manifolds* [arXiv:math.GT/0507004v3](#)
- [4] **F Bonahon**, *Bouts des variétés hyperboliques de dimension 3*, *Ann. of Math. (2)* 124 (1986) 71–158 [MR847953](#)
- [5] **R D Canary, D B A Epstein, P Green**, *Notes on notes of Thurston*, from: “Analytical and geometric aspects of hyperbolic space (Coventry/Durham, 1984)”, *London Math. Soc. Lecture Note Ser.* 111, Cambridge Univ. Press (1987) 3–92 [MR903850](#)
- [6] **D Cooper, D D Long**, *Virtually Haken Dehn-filling*, *J. Differential Geom.* 52 (1999) 173–187 [MR1743462](#)
- [7] **D Cooper, D D Long**, *Some surface subgroups survive surgery*, *Geom. Topol.* 5 (2001) 347–367 [MR1825666](#)
- [8] **D Cooper, D D Long, A W Reid**, *Essential closed surfaces in bounded 3-manifolds*, *J. Amer. Math. Soc.* 10 (1997) 553–563 [MR1431827](#)

- [9] **M Culler, P B Shalen**, *Bounded, separating, incompressible surfaces in knot manifolds*, Invent. Math. 75 (1984) 537–545 [MR735339](#)
- [10] **D B A Epstein, A Marden**, *Convex hulls in hyperbolic space, a theorem of Sullivan, and measured pleated surfaces*, from: “Analytical and geometric aspects of hyperbolic space (Coventry/Durham, 1984)”, London Math. Soc. Lecture Note Ser. 111, Cambridge Univ. Press (1987) 113–253 [MR903852](#)
- [11] **I Kapovich, A Myasnikov**, *Stallings foldings and subgroups of free groups*, J. Algebra 248 (2002) 608–668 [MR1882114](#)
- [12] **T Li**, *Immersed essential surfaces in hyperbolic 3-manifolds*, Comm. Anal. Geom. 10 (2002) 275–290 [MR1900752](#)
- [13] **A Marden**, *The geometry of finitely generated kleinian groups*, Ann. of Math. (2) 99 (1974) 383–462 [MR0349992](#)
- [14] **K Matsuzaki, M Taniguchi**, *Hyperbolic manifolds and Kleinian groups*, Oxford Mathematical Monographs, The Clarendon Press, Oxford University Press, New York (1998) [MR1638795](#)
- [15] **W Menasco**, *Closed incompressible surfaces in alternating knot and link complements*, Topology 23 (1984) 37–44 [MR721450](#)
- [16] **U Oertel**, *Closed incompressible surfaces in complements of star links*, Pacific J. Math. 111 (1984) 209–230 [MR732067](#)
- [17] **J G Ratcliffe**, *Foundations of hyperbolic manifolds*, Graduate Texts in Mathematics 149, Springer, New York (1994) [MR1299730](#)
- [18] **P Susskind**, *Kleinian groups with intersecting limit sets*, J. Analyse Math. 52 (1989) 26–38 [MR981494](#)
- [19] **W P Thurston**, *The topology and geometry of 3-manifolds*, Lecture notes, Princeton University (1979)
- [20] **Y-Q Wu**, *Immersed essential surfaces and Dehn surgery*, Topology 43 (2004) 319–342 [MR2052966](#)

Mathematics Department, SUNY at Buffalo

Buffalo, NY 14290, USA

jdmaster@buffalo.edu, xinzhang@buffalo.edu

Proposed: Dave Gabai

Seconded: Jean-Pierre Otal, Walter Neumann

Received: 28 March 2007

Revised: 1 February 2008