

involve

a journal of mathematics

Klein links and related torus links

Enrique Alvarado, Steven Beres, Vesta Coufal,
Kaia Hlavacek, Joel Pereira and Brandon Reeves



Klein links and related torus links

Enrique Alvarado, Steven Beres, Vesta Coufal,
Kaia Hlavacek, Joel Pereira and Brandon Reeves

(Communicated by Colin Adams)

In this paper, we present our constructions and results leading up to our discovery of a class of Klein links that are not equivalent to any torus links. In particular, we calculate the number and types of components in a $K_{p,q}$ Klein link and show that $K_{p,p} \equiv K_{p,p-1}$, $K_{p,2} \equiv T_{p-1,2}$, and $K_{2p,2p} \equiv T_{2p,p}$. Finally, we show that in contrast to the fact that every Klein knot is a torus knot, no Klein link $K_{p,p}$, where $p \geq 5$ is odd, is equivalent to a torus link.

1. Introduction

When we began thinking about Klein knots, we were told that they were uninteresting since all Klein knots are torus knots. We decided to see if we could prove that statement using elementary methods, and whether it was also true for Klein links. In this paper, we present our constructions and results leading up to our discovery of a class of Klein links that are not equivalent to any torus links. While results identical or similar to Theorems 2, 3, 4 and 5 are also proved in [Bowen et al. 2013; Bush et al. 2014; Freund and Smith-Polderman 2013; Shepherd et al. 2012] using braids, our approach uses different constructions and methods.

2. Constructions

Our construction of Klein knots and links is modeled after the standard construction of torus knots and links, as in [Adams 2004; Murasugi 2008]. Recall that for nonnegative integers p and q , the torus link $T_{p,q}$ is the link on the torus which crosses the longitude p times and crosses the meridian q times, with no crossing on the torus itself. We illustrate the construction of $T_{2,3}$ in Figure 1. Notice that we can translate the construction to a planar diagram as in Figure 1.

We will construct Klein knots and links in a similar way, being careful of certain issues. The first difficulty is that Klein bottles do not exist in three-dimensional

MSC2010: 57M25.

Keywords: knot theory, Klein links, torus links.

The authors received partial support from McDonald Work Awards .

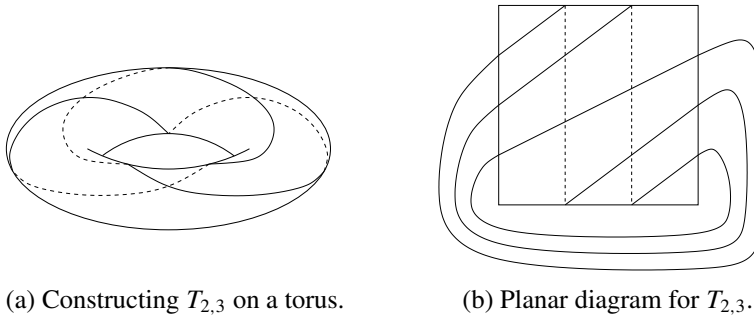

Figure 1. Torus knot $T_{2,3}$.

space, and knots are trivial in four-dimensional space. To get around this, we will work with punctured Klein bottles in three-dimensional space. The puncture occurs where the Klein bottle appears to (but does not) intersect itself. Warning: the knots and links we work with will be dependent on the relative position of the puncture. Mimicking the construction of $T_{p,q}$, the Klein link $K_{2,3}$ is illustrated in Figure 2. The corresponding planar diagram representation of $K_{2,3}$ is again modeled after the torus version, except that we need to account for the Möbius-band twist and be mindful of the puncture. By deforming the Klein bottle as in Figure 3, we see that the twist produces a pattern of additional crossings as in Figure 4, with the puncture occurring in the lower left corner. Note that $K_{p,0}$ is the p -component unlink.

In general, we construct $K_{p,q}$ on the planar diagram just as for $T_{p,q}$, except with the pattern of extra crossings. See Figure 5. We emphasize that the class of links that we are denoting by $K_{p,q}$ and the results in this paper are dependent on placing the puncture in the lower left corner. We do not consider Klein links with the puncture placed in different positions in this paper. Furthermore, deformations of our links are as links in space, not on the Klein bottle, and so the puncture does

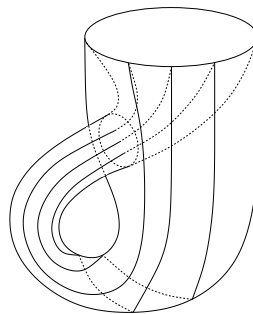

Figure 2. Klein link $K_{2,3}$.

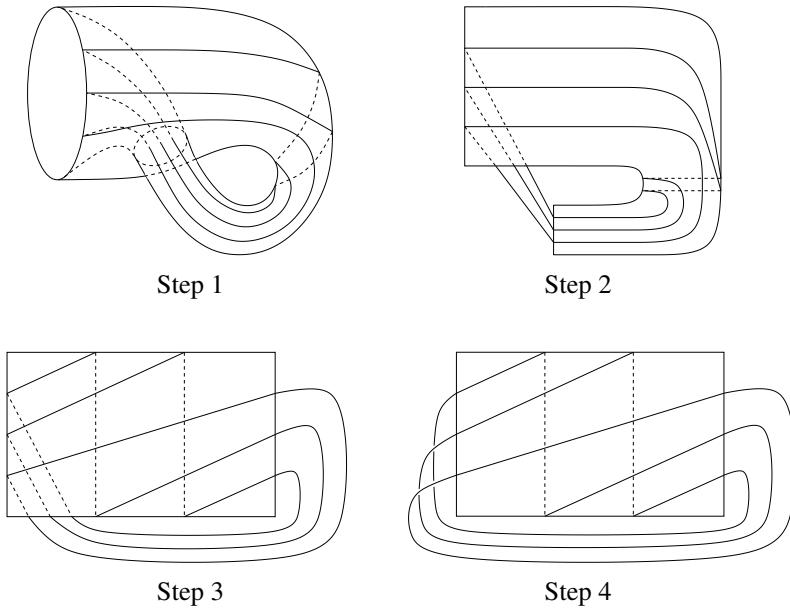

Figure 3. Deformations of $K_{2,3}$.

not affect deformations. For this reason, and since our puncture is always in the lower left corner, we do not include it in our illustrations.

It is worth noting that, while the diagrams are configured a bit differently, our $K_{p,q}$ Klein links are the same as the $K(p, q)$ Klein links found in [Bowen et al. 2013; Bush et al. 2014; Freund and Smith-Polderman 2013; Shepherd et al. 2012]. Additionally, some of the same authors of the previously cited papers have done preliminary work in which they found explicit relationships between Klein links with different choices of puncture. There are certainly more questions to be answered in this regard.

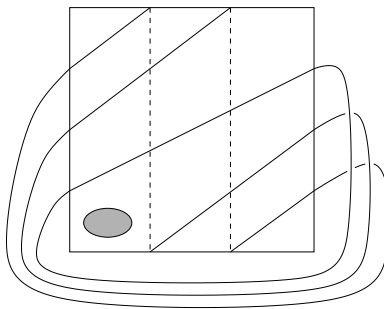

Figure 4. Planar diagram for $K_{2,3}$.

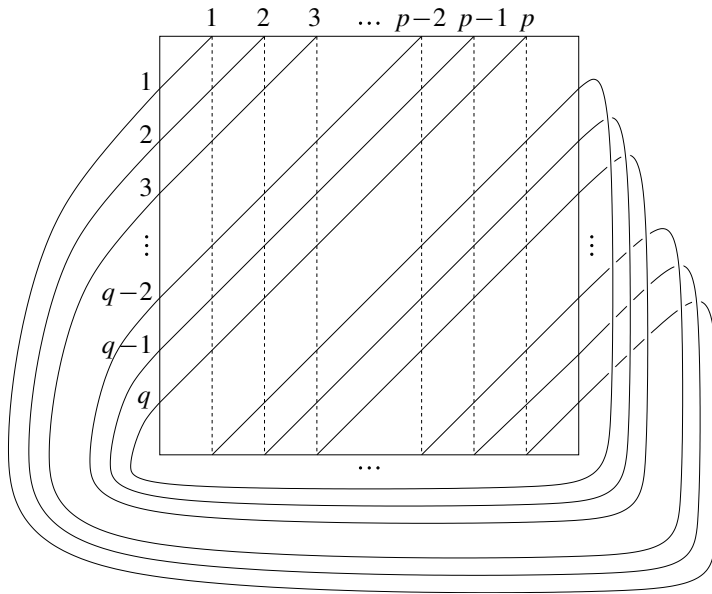

Figure 5. Planar diagram for $K_{p,q}$.

3. The wrapping function

The underlying key to many of our results is our “wrapping” function. Given a strand entering the left side of the rectangle in the planar diagram construction of $K_{p,q}$ (see Figure 6), the wrapping function determines where that particular strand re-enters the left side of the rectangle.

This allows us to count components, to characterize the types of components, and sometimes to tell that the components are unlinked. We have a similar wrapping

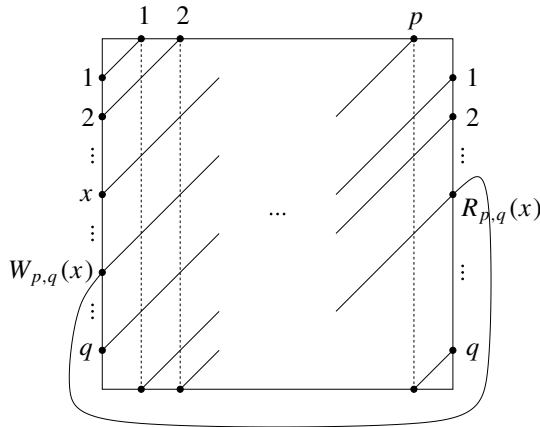

Figure 6. The wrapping function.

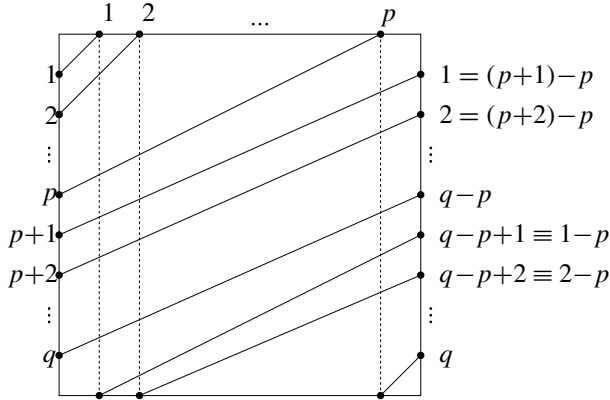

Figure 7. $R_{p,q}$ with $p \leq q$.

function and similar results for torus links, though we will concentrate only on our results for Klein links here.

Let $1 \leq x \leq q$, so that x is the position at which a particular strand passes through the left side of the planar diagram for $K_{p,q}$ as in Figure 6. Then the wrapping function is given by

$$W_{p,q}(x) = 1 - x + p \pmod{q}.$$

To see why this formula works, we will first back up a step and determine the position at which the strand entering the left side at x exits the right side of the planar diagram as shown in Figure 6; we denote this position by $R_{p,q}(x)$. In Figure 7, with $p \leq q$, we can see that

$$R_{p,q}(x) = x - p \pmod{q}.$$

In particular, notice that $R_{q,q}(x) = x - q = x \pmod{q}$, as one would expect. Next, if $p > q$, we divide p by q to get $p = nq + r$ for some $n, r \in \mathbb{N}$ with $1 \leq r \leq q$. By concatenating n copies of the planar diagram for $K_{q,q}$ and one copy of the diagram for $K_{r,q}$, we get that

$$\begin{aligned} R_{p,q}(x) &= R_{nq+r,q}(x) \\ &= R_{r,q} \circ R_{q,q} \circ R_{q,q} \circ \cdots \circ R_{q,q}(x) \\ &= R_{r,q}(x) \\ &= x - r \\ &= x - (p - nq) \\ &= x - p \pmod{q}. \end{aligned}$$

Finally, since strands exiting the right side of the planar diagram enter the left side in reverse order, we have that $W_{p,q}(x) = 1 - R_{p,q}(x) = 1 - x - p \pmod{q}$.

In our work, we will reference the following result about composing the wrapping function with itself.

Lemma 1. *For any $p, q \geq 0$, we have $W_{p,q}^2(x) = x$. Therefore, every component of $K_{p,q}$ wraps at most twice.*

Proof. Applying $W_{p,q}$ twice, we see that

$$\begin{aligned} W_{p,q}^2(x) &= W_{p,q} \circ W_{p,q}(x) = W_{p,q}(1 - x + p) \\ &= 1 - (1 - x + p) + p \\ &= x \pmod{q}. \end{aligned} \quad \square$$

4. Results

First we compute the number of components in a $K_{p,q}$ link and determine the types of components, results that we use to prove that $K_{5,5}$ is not equivalent to any torus link.

Theorem 2 (number of components). *If $q = 0$, then $K_{p,q}$ has p components. If $q \neq 0$, then the number of components of $K_{p,q}$ is*

$$\begin{cases} (q + 1)/2 & \text{if } q \text{ is odd,} \\ q/2 & \text{if } q \text{ and } p \text{ are both even,} \\ (q + 2)/2 & \text{if } q \text{ is even and } p \text{ is odd.} \end{cases}$$

Proof. For $q = 0$, no components wrap around the rectangle. So there is a component for each point on the top. Thus, there are p components.

For $q > 0$, by Lemma 1, each component wraps at most twice. We find how many components wrap once. If there are t components that wrap once, then there are $(q - t)/2$ components that wrap exactly twice. So there will be $(q - t)/2 + t = (q + t)/2$ components in all.

To find the number of components of $K_{p,q}$ that wrap once, we solve the modular equation

$$\begin{aligned} W_{p,q}(x) &= 1 - x + p = x \pmod{q}, \\ 2x - p - 1 &= 0 \pmod{q}. \end{aligned} \tag{1}$$

In other words, q divides $2x - p - 1$.

Case 1: q odd. Since we are adding modular q , without loss of generality, we can assume $p < q$. Since $x \leq q$, we have

$$q < 2x - p < 2q - p \implies q - 1 < 2x - p - 1 < 2q - p - 1.$$

Thus we have that $q - 1 < 2x - p - 1 < 2q$. So, if $2x - p - 1 \equiv 0 \pmod{q}$, then $2x - p - 1 = q$. Then there is one component that wraps once. So, for q odd, $K_{p,q}$ has $(q + 1)/2$ components.

Case 2: p and q even. Let $p = 2n$ and $q = 2r$. In this special case, (1) becomes

$$2(x - n) - 1 = 2rk \quad \text{for some } k \in \mathbb{Z}. \tag{2}$$

Notice that the left-hand side of (2) is odd while the right-hand side is even. So $W_{p,q}(x) \neq x$ for any x , and thus no components wrap once. Thus, for $K_{p,q} = K_{2n,2r}$, there are $q/2 = r$ components.

Case 3: p odd, q even. Let $p = 2n + 1$ for some integer n and $q = 2r$ for some integer r . Then, (1) becomes $2(x - n - 1) \equiv 0 \pmod{q}$. Now since $x \leq q$, we have

$$2(x - n - 1) < 2(q - n - 1) < 2q.$$

Thus the only possibilities for (1) to be true are $2(x - n - 1) = 0$ or $2(x - n - 1) = q$. So, there are exactly two components of $K_{p,q}$ that wrap once, namely when $x = n + 1$ and $x = n + 1 + q/2$. Then, for $K_{p,q}$, there are $(q + 2)/2$ components. \square

The components of a link are knots. More generally, a link can be viewed as a collection of sublinks, possibly tangled together. For notational purposes, if a link L is made up of m copies of a sublink M and n copies of a sublink N , we will write $L \equiv m \cdot M \cup n \cdot N$. In the next theorem, we determine the types of knots that make up a Klein link.

Theorem 3 (types of components). *If $p < q$, then*

$$K_{p,q} \equiv K_{p,p} \cup K_{0,q-p},$$

where the sublink $K_{p,p}$ is disjoint (untangled) from $K_{0,q-p}$. Furthermore:

(1) *If $q = 2n + r$ with $n \in \mathbb{N}$ and $r = 0$ or $r = 1$, then*

$$K_{0,q} \equiv n \cdot K_{0,2} \cup r \cdot K_{0,1}.$$

(2) *If $p = 2n + r$ with $n \in \mathbb{N}$ and $r = 0$ or $r = 1$, then*

$$K_{p,p} \equiv n \cdot K_{2,2} \cup r \cdot K_{1,1}.$$

Proof. We begin by showing that if $p < q$, then $K_{p,q} \equiv K_{p,p} \cup K_{0,q-p}$. Let X_1 be the positions $1, 2, \dots, p$ on the left side of the planar diagram for $K_{p,q}$, as shown in Figure 8. Similarly, let X_2 be the positions $p + 1, \dots, q$ on the left, Y_1 be the positions $1, \dots, q - p$ on the right, and Y_2 be the positions $q - p + 1, \dots, q$ on the right.

Notice that $|X_1| = |Y_2| = p$ and $|X_2| = |Y_1| = q - p$.

By construction of the planar diagram for $K_{p,q}$ with $p < q$, strands from the p positions in X_1 pass through the p positions on the top of the diagram, then through

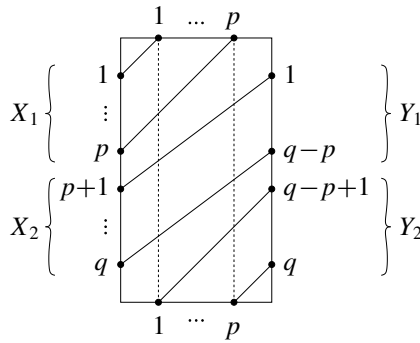

Figure 8. X_1, X_2, Y_1 and Y_2 .

the p positions on the bottom of the diagram, and hence to the p positions in Y_2 . Throughout, the order is preserved. In other words, $R_{p,q}|_{X_1} : X_1 \rightarrow Y_2$ is a bijection. Similarly, strands from the $q - p$ positions in X_2 cross the diagram directly to the $q - p$ positions in Y_1 , preserving order, and $R_{p,q}|_{X_2} : X_2 \rightarrow Y_1$ is also a bijection.

Inside of the rectangle in the diagram, all strands from X_2 on the left cross over all strands from X_1 before passing through positions in Y_1 . Outside of the rectangle, these same strands exit from positions in Y_1 , cross over all strands exiting from Y_2 , and re-enter through X_2 in reverse order. Thus $W_{p,q}|_{X_2} : X_2 \rightarrow X_2$, and the strands passing through positions in X_2 form a link L_2 that crosses over all other strands in $K_{p,q}$. Similarly, strands through positions in X_1 pass under strands from X_2 both inside and outside the rectangle in the diagram, $W_{p,q}|_{X_1} : X_1 \rightarrow X_1$, and these strands form another link L_1 completely disjoint from L_2 . These two links are illustrated in Figure 9.

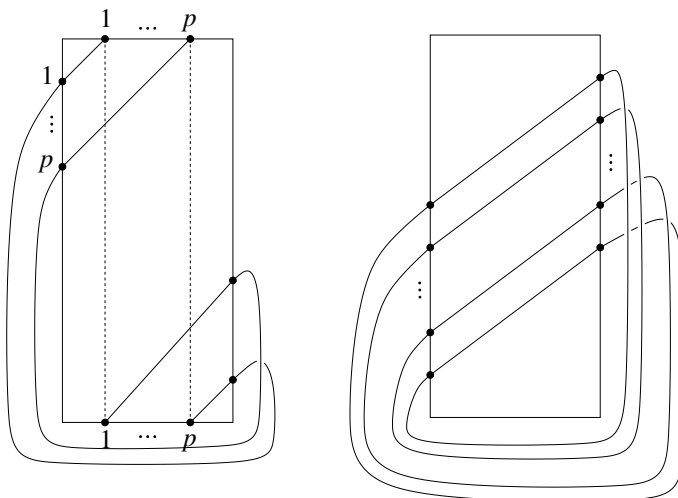

Figure 9. The links L_1 (left) and L_2 (right).

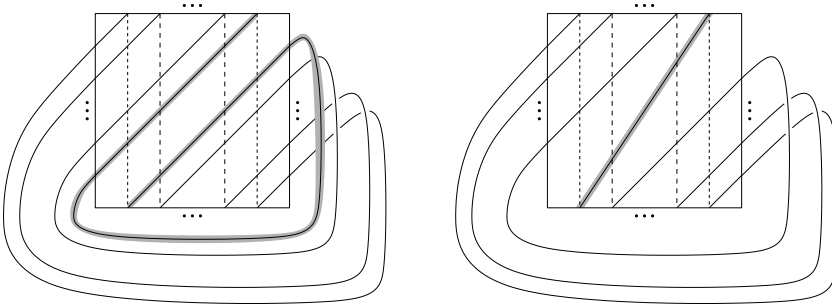

Figure 10. Planar diagrams of $K_{p,p}$ (left) and $K_{p,p-1}$ (right).

Viewed separately, these disjoint links are $L_1 = K_{p,p}$ and $L_2 = K_{0,q-p}$. Thus $K_{p,q} \equiv K_{p,p} \cup K_{0,q-p}$.

Since $K_{p,q}$ is composed of the two links $K_{p,p}$ and $K_{0,q-p}$, our next step is to characterize the components of Klein links of these types.

Consider $K_{0,q}$ for any value of $q \geq 1$. By Lemma 1, for all $0 < x \leq q$, we have $W_{0,q}^2(x) = x$, and hence each component of $K_{0,q}$ wraps horizontally around the rectangle in the planar diagram at most twice. It follows that each component is either a $K_{0,1}$ or a $K_{0,2}$. Now, to have a $K_{0,1}$ component, we must have some $0 < x \leq q$ such that $x = W_{0,q}(x) = 1 - x \pmod{q}$. This occurs exactly when q divides $x - (1 - x) = 2x - 1$, that is, exactly when q is odd. In this case, $q = 2n + 1$ for some positive integer n (and $r = 1$ in the statement of the theorem). Since $2x - 1 \leq 2q - 1 < 2q$, we see that $W_{0,q}(x) = x$ implies that $2x - 1 = q$. Thus, there is only one component of the form $K_{0,1}$ which passes through $x = (q + 1)/2$. Since all other components wrap twice, there are n components of the form $K_{0,2}$, and $K_{0,q} \equiv n \cdot K_{0,2} \cup K_{0,1}$. On the other hand, suppose q is even with $q = 2n$ for some positive integer n (and $r = 0$). Then every component wraps twice, so $K_{0,q} \equiv n \cdot K_{0,2}$.

For $K_{p,p}$, since every component wraps at most twice, every component is of the form $K_{2,2}$ or $K_{1,1}$. Similar to the $K_{0,q}$ situation, there is at most one component of type $K_{1,1}$ and it exists if and only if p is odd. Therefore, if $p = 2n + r$ with $r = 0$ or 1 , we have $K_{p,p} \equiv n \cdot K_{2,2} \cup r \cdot K_{1,1}$. □

Above we see that $K_{p,p}$ has components consisting entirely of the knots $K_{2,2}$ and $K_{1,1}$. It turns out that we can also view $K_{p,p}$ as the slightly simpler Klein link $K_{p,p-1}$.

Theorem 4 (Klein to Klein). *If $p \in \mathbb{N}$, then $K_{p,p} \equiv K_{p,p-1}$.*

Proof. By construction, the diagram of $K_{p,p}$ has a loop sitting on top of the rest of the link. This top loop, which is highlighted in Figure 10 (left), can be pulled tight (with one of the basic Reidemeister moves), turning the double diagonal strands into one diagonal strand. The resulting diagram, Figure 10 (right), is the link $K_{p,p-1}$. □

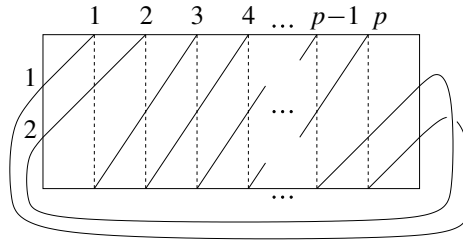

Figure 11. Planar diagram of $K_{p,2}$.

Now we are ready to compare Klein links and torus links. Recall that all Klein knots are torus knots. Similarly, certain classes of Klein links are torus links. In the next two theorems, we investigate Klein links of the forms $K_{p,2}$ and $K_{2p,2p}$.

Theorem 5 (Klein to torus, I). *If $p \in \mathbb{N}$, then $K_{p,2} \equiv T_{p-1,2}$.*

Proof. Consider the planar diagram of $K_{p,2}$ as in Figure 11.

Notice the crossing on the right of the planar diagram, in particular the strand that crosses underneath. If we follow this strand to the left, it wraps under the planar diagram. By unwrapping this strand and pulling it upward, the crossing is now gone. (This is a type-II Reidemeister move.) The resultant diagram is shown in Figure 12 (left).

We no longer have two nodes on the right side of the planar diagram. However, we may slide the strand so the strand exits the planar diagram from the right side as opposed to the top side. See Figure 12 (right).

So there are $p - 1$ nodes along the top and two nodes along the side. Notice the strand that exits on the top node on the right enters through the top node on the left, and similarly the strand that exits on the bottom node on the right enters through the bottom node on the left. Thus, we obtain the planar diagram for $T_{p-1,2}$ and $K_{p,2} \equiv T_{p-1,2}$. \square

Theorem 6 (Klein to torus, II). *If $p \in \mathbb{N}$, then $K_{2p,2p} \equiv T_{2p,p}$.*

Proof. A general $K_{2p,2p}$ has $2p$ strands entering or leaving each side of the rectangle in the planar diagram. Instead of manipulating each strand separately, we will collect

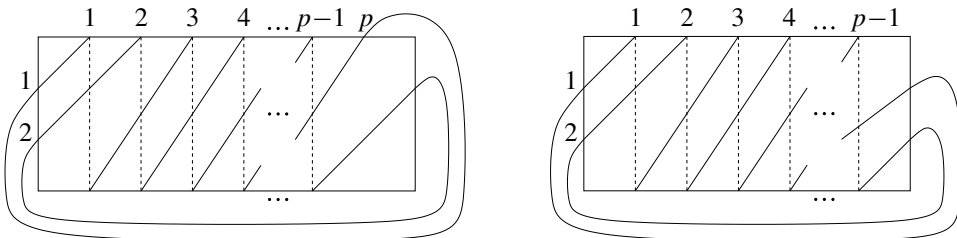

Figure 12. $K_{p,2}$ with crossing removed (left) and with two nodes on right restored (right).

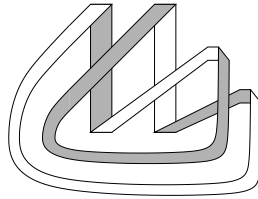

Figure 13. $K_{2p,2p}$ as a ribbon.

together the first p strands entering the left side of the rectangle as if they are on a ribbon, as illustrated in Figure 13.

Manipulating the ribbon moves the p strands together, resulting in an equivalent link. Our first steps are to flip up the inner loop of the ribbon, and unfold the lower right portion of the ribbon, resulting in Figure 14(a). In Figure 14(b), we turn the loop into a twist in the ribbon, and in Figure 14(c), we push the twist down to produce a fold. Returning to the p strands instead of the ribbon, we now have $T_{2p,p}$, as desired. \square

The final class of Klein links that we consider are those of the form $K_{b,b}$ where $b \geq 5$ is odd. We will use linking numbers in our proof. To denote the linking number for an oriented link L of more than two components, we use the notation $\text{lk}(L) = [l_1, l_2, \dots, l_n]$, where l_1, l_2, \dots, l_n are the individual linking numbers of each two-component pair and are arranged in no particular order. This is not the total linking number found in [Bush et al. 2014; Murasugi 2008] which goes one step further by summing up the pair-wise linking numbers.

Theorem 7 (Klein not torus). *Let $b \geq 5$ be an odd integer. For every choice of $p, q \in \mathbb{N}$, we have $K_{b,b} \not\cong T_{p,q}$. In other words, $K_{b,b}$ is not a torus link.*

Proof. By Theorem 2, $K_{b,b}$ has $c = (b + 1)/2$ components, and by Theorem 3, one of the components is a copy of $K_{1,1}$ and all of the other components are copies of $K_{2,2}$. Note that both $K_{2,2}$ and $K_{1,1}$ are unknots.

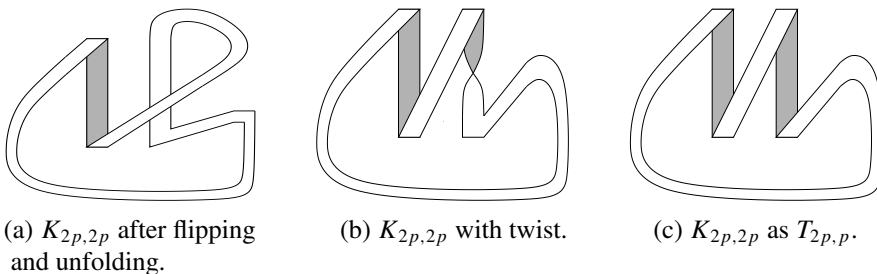

Figure 14. Deforming $K_{2p,2p}$ into $T_{2p,p}$.

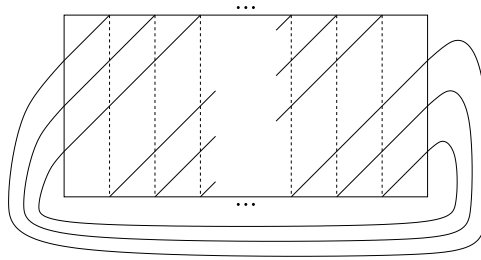

Figure 15. $T_{3m,3}$.

If $K_{b,b} \equiv T_{p,q}$, then $T_{p,q}$ must also have $c = (b + 1)/2$ components. It is well known (see [Adams 2004; Murasugi 2008]) that $T_{p,q}$ has c components exactly when $\gcd(p, q) = c$. So we let $p = mc$ and $q = nc$, where $m, n \in \mathbb{N}$ with $\gcd(m, n) = 1$. Then, as determined in [Murasugi 2008], $T_{p,q} \equiv T_{mc,nc} \equiv c \cdot T_{m,n}$. Furthermore, we may assume that $m > n$ without loss of generality since $T_{p,q} \equiv T_{q,p}$ for all p, q (see [Adams 2004; Murasugi 2008]). As noted above, each individual component of $K_{b,b}$ is an unknot. From our (very convenient) knowledge of torus knots and [Murasugi 2008], a torus knot $T_{m,n}$ is equivalent to the unknot only when $n = 1$. So if $K_{b,b}$ is equivalent to some torus link, it must be the case that $K_{b,b} \equiv T_{mc,c}$.

In order to determine if $K_{b,b} \equiv T_{mc,c}$ for some m , we examine the linking numbers. From our standard planar diagram of $K_{b,b}$, regardless of orientation, we have that $\text{lk}(K_{b,b}) = [2, \dots, 2, 1, \dots, 1]$. Any pair of components consisting of the copy of $K_{1,1}$ and one of the copies of $K_{2,2}$ has four crossings within the rectangle in the planar diagram, all of the same type, and two crossings outside of the rectangle, all of the opposite type, resulting in a crossing number of $(4 - 2)/2 = 1$. Any pair consisting of two copies of $K_{2,2}$ has eight crossings within the rectangle and four opposite crossings outside of the rectangle, and hence a linking number of $(8 - 4)/2 = 2$.

Now consider the planar diagram for the general $T_{mc,c}$. As an example, $T_{3m,3}$ is shown in Figure 15. Orient each strand entering the left side of the rectangle in an upward direction. Consider the block on the left side of the diagram corresponding to the first c points along the top of the rectangle. In this block, each component crosses each of the other components exactly twice, and each crossing is left-handed. The same thing happens in each of the m blocks corresponding to groups of c points along the top of the rectangle. Thus the linking number between any two components in the $T_{mc,c}$ is $|-2m|/2 = m$ and consequently $\text{lk}(T_{mc,c}) = [m, m, \dots, m] \neq [2, \dots, 2, 1, \dots, 1]$. So there is no m for which $K_{b,b} \equiv T_{mc,c}$. Hence, $K_{b,b} \not\equiv T_{p,q}$ for any choice of p, q . \square

Since all Klein knots are also torus knots, we expected all Klein links to be torus links. So this last result was a pleasant surprise.

References

- [Adams 2004] C. C. Adams, *The knot book: An elementary introduction to the mathematical theory of knots*, Amer. Math. Soc., Providence, RI, 2004. MR 2005b:57009 Zbl 1065.57003
- [Bowen et al. 2013] J. Bowen, D. Freund, J. Ramsay, and S. Smith-Polderman, “Klein link multiplicity and recursion”, preprint, 2013, available at <http://discover.wooster.edu/jbowen/files/2013/10/Klein-Link-Multiplicity-and-Recursion.pdf>.
- [Bush et al. 2014] M. A. Bush, K. R. French, and J. R. H. Smith, “Total linking numbers of torus links and klein links”, *Rose-Hulman Undergrad. Math J.* **15**:1 (2014), 73–92. MR 3216221
- [Freund and Smith-Polderman 2013] D. Freund and S. Smith-Polderman, “Klein links and braids”, *Rose-Hulman Undergrad. Math J.* **14**:1 (2013), 71–84. MR 3071244
- [Murasugi 2008] K. Murasugi, *Knot theory & its applications*, Birkhäuser, Boston, 2008. MR 2347576 Zbl 1138.57001
- [Shepherd et al. 2012] D. Shepherd, J. Smith, S. Smith-Polderman, J. Bowen, and J. Ramsay, “The classification of a subset of klein links”, *Proceedings of the Midstates Conference for Undergraduate Research in Computer Science and Mathematics at Ohio Wesleyan University* (2012), 38–47.

Received: 2015-01-03 Revised: 2015-02-23 Accepted: 2015-02-26

ealvarado9611@gmail.com *Department of Mathematics, Washington State University,
Pullman, WA 99164, United States*

sberes@zagmail.gonzaga.edu *Department of Mathematics, Gonzaga University,
Spokane, WA 99258, United States*

coufal@gonzaga.edu *Department of Mathematics, Gonzaga University,
Spokane, WA 99258, United States*

khlavacek@zagmail.gonzaga.edu *Department of Mathematics, Gonzaga University,
Spokane, WA 99258, United States*

pereira@gonzaga.edu *Department of Mathematics, Gonzaga University,
Spokane, WA 99258, United States*

breeves@wisc.edu *Department of Economics, University of Wisconsin,
Madison, WI 53706, United States*

involve

msp.org/involve

MANAGING EDITOR

Kenneth S. Berenhaut, Wake Forest University, USA, berenhks@wfu.edu

BOARD OF EDITORS

Colin Adams	Williams College, USA colin.c.adams@williams.edu	David Larson	Texas A&M University, USA larson@math.tamu.edu
John V. Baxley	Wake Forest University, NC, USA baxley@wfu.edu	Suzanne Lenhart	University of Tennessee, USA lenhart@math.utk.edu
Arthur T. Benjamin	Harvey Mudd College, USA benjamin@hmc.edu	Chi-Kwong Li	College of William and Mary, USA ckli@math.wm.edu
Martin Bohner	Missouri U of Science and Technology, USA bohner@mst.edu	Robert B. Lund	Clemson University, USA lund@clemson.edu
Nigel Boston	University of Wisconsin, USA boston@math.wisc.edu	Gaven J. Martin	Massey University, New Zealand g.j.martin@massey.ac.nz
Amarjit S. Budhiraja	U of North Carolina, Chapel Hill, USA budhiraj@email.unc.edu	Mary Meyer	Colorado State University, USA meyer@stat.colostate.edu
Pietro Cerone	La Trobe University, Australia P.Cerone@latrobe.edu.au	Emil Minchev	Ruse, Bulgaria eminchev@hotmail.com
Scott Chapman	Sam Houston State University, USA scott.chapman@shsu.edu	Frank Morgan	Williams College, USA frank.morgan@williams.edu
Joshua N. Cooper	University of South Carolina, USA cooper@math.sc.edu	Mohammad Sal Mosehian	Ferdowsi University of Mashhad, Iran moslehian@ferdowsi.um.ac.ir
Jem N. Corcoran	University of Colorado, USA corcoran@colorado.edu	Zuhair Nashed	University of Central Florida, USA znashed@mail.ucf.edu
Toka Diagana	Howard University, USA tdiagana@howard.edu	Ken Ono	Emory University, USA ono@mathcs.emory.edu
Michael Dorff	Brigham Young University, USA mdorff@math.byu.edu	Timothy E. O'Brien	Loyola University Chicago, USA tobrie1@luc.edu
Sever S. Dragomir	Victoria University, Australia sever@matilda.vu.edu.au	Joseph O'Rourke	Smith College, USA orourke@cs.smith.edu
Behrouz Emamizadeh	The Petroleum Institute, UAE bemamizadeh@pi.ac.ae	Yuval Peres	Microsoft Research, USA peres@microsoft.com
Joel Foisy	SUNY Potsdam foisyjs@potsdam.edu	Y.-F. S. Pétermann	Université de Genève, Switzerland petermann@math.unige.ch
Errin W. Fulp	Wake Forest University, USA fulp@wfu.edu	Robert J. Plemmons	Wake Forest University, USA rplemmons@wfu.edu
Joseph Gallian	University of Minnesota Duluth, USA jgallian@d.umn.edu	Carl B. Pomerance	Dartmouth College, USA carl.pomerance@dartmouth.edu
Stephan R. Garcia	Pomona College, USA stephan.garcia@pomona.edu	Vadim Ponomarenko	San Diego State University, USA vadim@sciences.sdsu.edu
Anant Godbole	East Tennessee State University, USA godbole@etsu.edu	Bjorn Poonen	UC Berkeley, USA poonen@math.berkeley.edu
Ron Gould	Emory University, USA rg@mathcs.emory.edu	James Propp	U Mass Lowell, USA jpropp@cs.uml.edu
Andrew Granville	Université Montréal, Canada andrew@dms.umontreal.ca	József H. Przytycki	George Washington University, USA przytyck@gwu.edu
Jerrold Griggs	University of South Carolina, USA griggs@math.sc.edu	Richard Rebarber	University of Nebraska, USA rrebarbe@math.unl.edu
Sat Gupta	U of North Carolina, Greensboro, USA sngupta@uncg.edu	Robert W. Robinson	University of Georgia, USA rwr@cs.uga.edu
Jim Haglund	University of Pennsylvania, USA jhaglund@math.upenn.edu	Filip Saidak	U of North Carolina, Greensboro, USA f_saidak@uncg.edu
Johnny Henderson	Baylor University, USA johnny_henderson@baylor.edu	James A. Sellers	Penn State University, USA sellersj@math.psu.edu
Jim Hoste	Pitzer College jhoste@pitzer.edu	Andrew J. Sterge	Honorary Editor andy@ajsterge.com
Natalia Hritonenko	Prairie View A&M University, USA nahritonenko@pvamu.edu	Ann Trenk	Wellesley College, USA atrenk@wellesley.edu
Glenn H. Hurlbert	Arizona State University, USA hurlbert@asu.edu	Ravi Vakil	Stanford University, USA vakil@math.stanford.edu
Charles R. Johnson	College of William and Mary, USA crjohnso@math.wm.edu	Antonia Vecchio	Consiglio Nazionale delle Ricerche, Italy antonia.vecchio@cnr.it
K. B. Kulasekera	Clemson University, USA kk@ces.clemson.edu	Ram U. Verma	University of Toledo, USA verma99@msn.com
Gerry Ladas	University of Rhode Island, USA gladas@math.uri.edu	John C. Wierman	Johns Hopkins University, USA wierman@jhu.edu
		Michael E. Zieve	University of Michigan, USA zieve@umich.edu

PRODUCTION

Silvio Levy, Scientific Editor

Cover: Alex Scorpan

See inside back cover or msp.org/involve for submission instructions. The subscription price for 2016 is US \$160/year for the electronic version, and \$215/year (+\$35, if shipping outside the US) for print and electronic. Subscriptions, requests for back issues from the last three years and changes of subscribers address should be sent to MSP.

Involve (ISSN 1944-4184 electronic, 1944-4176 printed) at Mathematical Sciences Publishers, 798 Evans Hall #3840, c/o University of California, Berkeley, CA 94720-3840, is published continuously online. Periodical rate postage paid at Berkeley, CA 94704, and additional mailing offices.

Involve peer review and production are managed by EditFLOW[®] from Mathematical Sciences Publishers.

PUBLISHED BY

 **mathematical sciences publishers**
nonprofit scientific publishing

<http://msp.org/>

© 2016 Mathematical Sciences Publishers

involve

2016

vol. 9

no. 2

On the independence and domination numbers of replacement product graphs JAY CUMMINGS AND CHRISTINE A. KELLEY	181
An optional unrelated question RRT model JEONG S. SIHM, ANU CHHABRA AND SAT N. GUPTA	195
On counting limited outdegree grid digraphs and greatest increase grid digraphs JOSHUA CHESTER, LINNEA EDLIN, JONAH GALEOTA-SPRUNG, BRADLEY ISOM, ALEXANDER MOORE, VIRGINIA PERKINS, A. MALCOLM CAMPBELL, TODD T. ECKDAHL, LAURIE J. HEYER AND JEFFREY L. POET	211
Polygonal dissections and reversions of series ALISON SCHUETZ AND GWYN WHIELDON	223
Factor posets of frames and dual frames in finite dimensions KILEEN BERRY, MARTIN S. COPENHAVER, ERIC EVERT, YEON HYANG KIM, TROY KLINGLER, SIVARAM K. NARAYAN AND SON T. NGHIEM	237
A variation on the game SET DAVID CLARK, GEORGE FISK AND NURULLAH GOREN	249
The kernel of the matrix $[ij \pmod n]$ when n is prime MARIA I. BUENO, SUSANA FURTADO, JENNIFER KARKOSKA, KYANNE MAYFIELD, ROBERT SAMALIS AND ADAM TELATOVICH	265
Harnack's inequality for second order linear ordinary differential inequalities AHMED MOHAMMED AND HANNAH TURNER	281
The isoperimetric and Kazhdan constants associated to a Paley graph KEVIN CRAMER, MIKE KREBS, NICOLE SHABAZI, ANTHONY SHAHEEN AND EDWARD VOSKANIAN	293
Mutual estimates for the dyadic reverse Hölder and Muckenhoupt constants for the dyadically doubling weights OLEKSANDRA V. BEZNOVA AND TEMITOPE ODE	307
Radio number for fourth power paths MIN-LIN LO AND LINDA VICTORIA ALEGRIA	317
On closed graphs, II DAVID A. COX AND ANDREW ERSKINE	333
Klein links and related torus links ENRIQUE ALVARADO, STEVEN BERES, VESTA COUFAL, KAIA HLAVACEK, JOEL PEREIRA AND BRANDON REEVES	347



1944-4176(2016)9:2;1-3