

involve

a journal of mathematics

New examples of Brunnian theta graphs

Byoungwook Jang, Anna Kronaueur, Pratap Luitel,
Daniel Medici, Scott A. Taylor and Alexander Zupan



New examples of Brunnian theta graphs

Byoungwook Jang, Anna Kronaueur, Pratap Luitel,
Daniel Medici, Scott A. Taylor and Alexander Zupan

(Communicated by Joel Foisy)

The Kinoshita graph is the most famous example of a Brunnian theta graph, a nontrivial spatial theta graph with the property that removing any edge yields an unknot. We produce a new family of diagrams of spatial theta graphs with the property that removing any edge results in the unknot. The family is parameterized by a certain subgroup of the pure braid group on four strands. We prove that infinitely many of these diagrams give rise to distinct Brunnian theta graphs.

1. Introduction

A *spatial theta graph* is a theta graph (two vertices and three edges, each joining the two vertices) embedded in the 3-sphere S^3 . There is a rich theory of spatial theta graphs and they show up naturally in knot theory. (For instance, the union of a tunnel number 1 knot with a tunnel having distinct endpoints is a spatial theta graph.) A *trivial spatial theta graph* is any spatial theta graph which is isotopic into a 2-sphere in S^3 . A spatial theta graph $G \subset S^3$ has the *Brunnian property* if for each edge $e \subset G$ the knot $K_e = G \setminus e$ which is the result of removing the interior of e from G is the unknot. A spatial theta graph is *Brunnian* (or *almost unknotted* or *minimally knotted*) if it is nontrivial and has the Brunnian property.

By far the best known Brunnian theta graph is the Kinoshita graph [1958;1972]. The Kinoshita graph was generalized by Wolcott [1987] to a family of Brunnian theta graphs now called the Kinoshita–Wolcott graphs. They are pictured in Figure 1. Inspection shows that they have the Brunnian property. There are several approaches to showing that the Kinoshita graph (and perhaps all of the Kinoshita–Wolcott graphs) are nontrivial: Wolcott [1987] uses double branched covers; Litherland [1989] uses a version of the Alexander polynomial; Scharlemann [1992] and Livingston [1995] use representations of certain associated groups; McAtee et al. [2001] use quandles; Thurston [1997] showed that the Kinoshita graph is hyperbolic (i.e., the exterior supports a complete hyperbolic structure with totally geodesic boundary).

MSC2010: 57M25.

Keywords: spatial graph, almost unknotted graph, Brunnian, theta graph, theta curve, rational tangle.

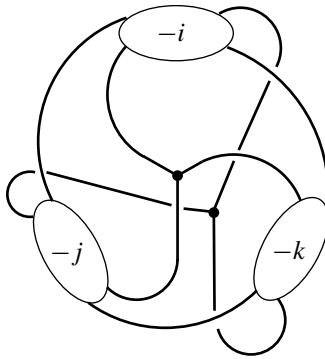

Figure 1. The Kinoshita–Wolcott graphs (figure based on [Litherland 1989, Figure 4]). The labels $-i$, $-j$, and $-k$ indicate the number of full twists in each box (with the sign of $-i$, $-j$, $-k$ indicating the direction of the twisting). If $i = j = k = 1$, the graph is the Kinoshita graph. If one of i , j or k is zero, then the graph is trivial; otherwise, it is Brunnian [Wolcott 1987, Theorem 2.1].

In this paper, we produce an infinite family of diagrams for spatial theta graphs $G(A, t_1, t_2)$ having the Brunnian property. These graphs depend on braids A lying in a certain subgroup of the pure braid group on 4 strands and on integers t_1, t_2 which represent certain twisting parameters. Our main theorem shows that infinitely many braids A give rise to Brunnian theta graphs.

Theorem 5.1 (rephrased). *For all $n \in \mathbb{Z}$, there exists a braid A_n such that for all $m \in \mathbb{Z}$, the graph $\Gamma(n, m) = G(A_n, -n, m)$ is a Brunnian theta graph. Furthermore, suppose that for a given $(n, m) \in \mathbb{Z} \times \mathbb{Z}$, the set $S(n, m) \subset \mathbb{Z} \times \mathbb{Z}$ has the property that if $(a, b) \in S(n, m)$ then $\Gamma(a, b)$ is isotopic to $\Gamma(n, m)$ and if $(a, b), (a', b') \in S(n, m)$ are distinct, then $a + b \neq a' + b'$. Then $S(n, m)$ has at most three distinct elements. In particular, there exist infinitely many $n \in \mathbb{Z}$ such that the graphs $\Gamma(n, 0)$ are pairwise nonisotopic Brunnian theta graphs.*

2. Notation

We work in either the PL or smooth category. For a topological space X , we let $|X|$ denote the number of components of X . If $Y \subset X$ then $\eta(Y)$ is a closed regular neighborhood of Y in X and $\mathring{\eta}(Y)$ is an open regular neighborhood. More generally, \mathring{Y} denotes the interior of Y .

3. Constructing new Brunnian theta graphs

There are two natural methods for constructing new Brunnian theta graphs: vertex sums and clasping.

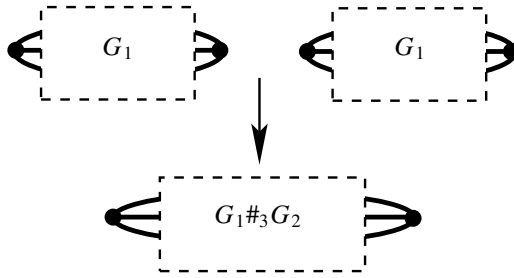

Figure 2. A schematic depiction of the vertex sum of two spatial theta graphs.

Vertex sums. Suppose that $G_1 \subset S^3$ and $G_2 \subset S^3$ are spatial theta graphs. Let $v_1 \in G_1$ and $v_2 \in G_2$ be vertices. We can construct a new spatial theta graph $G_1 \#_3 G_2 \subset S^3$ by taking the connected sum of S^3 with S^3 by removing regular open neighborhoods of v_1 and v_2 and gluing the resulting 3-balls B_1 and B_2 together by a homeomorphism $\partial B_1 \rightarrow \partial B_2$ taking the punctures $G_1 \cap \partial B_1$ to the punctures $G_2 \cap \partial B_2$. See Figure 2. The subscripted 3 represents the fact that we are performing the connected sum along a trivalent vertex and is used to distinguish the vertex sum from the connected sum of graphs occurring along edges of a graph (which, when both G_1 and G_2 are theta graphs, does not produce a theta graph).

An orientation on a spatial theta graph is a choice of one vertex to be the *source*, one vertex to be the *sink*, and a choice of a total order on the edges of the graph. If G_1 and G_2 are oriented theta graphs, we insist that the connected sum produce an oriented theta graph (so that the sink vertex of G_1 is glued to the source vertex of G_2 and so that the edges of $G_1 \#_3 G_2$ can be given an ordering which restricts to the given orderings on the edges of G_1 and G_2). Wolcott [1987] showed that the vertex sum of oriented theta graphs is independent (up to ambient isotopy of the graph) of the choice of homeomorphism $\partial B_1 \rightarrow \partial B_2$.

If G_1 and G_2 both have the Brunnian property, then $G_1 \#_3 G_2$ does as well since the connected sum of two knots is the unknot if and only if both of the original knots are unknots. If G_1 (say) is trivial, then $G_1 \#_3 G_2$ is isotopic to G_2 . Similarly, if at least one of G_1 or G_2 is nontrivial then $G_1 \#_3 G_2$ is nontrivial [Wolcott 1987]. Consequently:

Theorem 3.1 (Wolcott). *If G_1 and G_2 are Brunnian theta graphs so is $G_1 \#_3 G_2$.*

We say that a spatial theta graph is *vertex-prime* if it is not the vertex sum of two other nontrivial spatial theta graphs. The Kinoshita graph is vertex prime [Calcut and Metcalf-Burton 0]. Using Thurston's hyperbolization theorem for Haken manifolds, it is possible to show that if G_1 and G_2 are theta graphs, then $G_1 \#_3 G_2$ is hyperbolic if and only if G_1 and G_2 are hyperbolic.

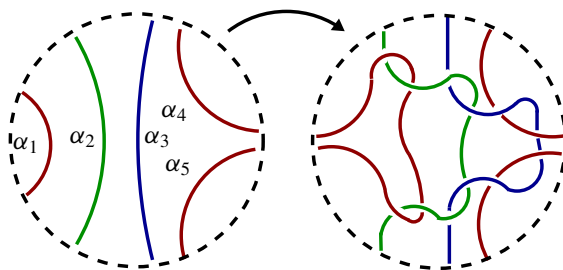

Figure 3. The clasp move in the case when all three edges of the graph are involved.

Clasping. Clasping [Simon and Wolcott 1990] is a second method for converting a Brunnian theta graph into another theta graph with the Brunnian property. Suppose that G is a spatial theta graph in S^3 which has been isotoped so that its intersection with a 3-ball $B \subset S^3$ consists of four unknotted arcs (as on the left of Figure 3), numbered $\alpha_1, \alpha_2, \alpha_3, \alpha_4$, and α_5 . Assume that the first arc and the last two arcs belong to the same edge (the “red edge”) of G and that the others belong to different, distinct edges of G (the “green edge” and the “blue edge”). We require that as we traverse the red edge, the arc α_1 is traversed between α_4 and α_5 . Letting e' be the subarc of the red edge containing $\alpha_4 \cup \alpha_1 \cup \alpha_5$, we also require that there is an isotopy of e' , in the complement of the rest of the graph, to an unknotted arc in B . As in Figure 3, we may then perform crossing changes to introduce a clasps between adjacent arcs. It is easily checked that this clasp move preserves the Brunnian property.

Although the clasp move creates many Brunnian theta graphs, it is not clear how to keep track of fundamental properties (such as hyperbolicity) under the clasp move. Additionally, very little is known about sequences of clasp moves relating two Brunnian theta graphs.

We can, however, use clasping to show that there exist Brunnian theta graphs which are *not* hyperbolic. Figure 4 shows an example of a Brunnian theta graph with

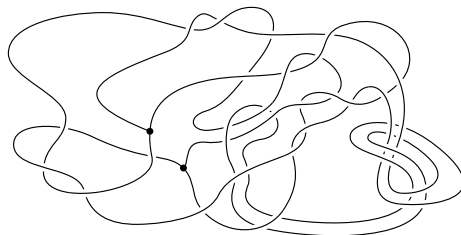

Figure 4. A toroidal Brunnian theta graph. The swallow-follow torus for the double-stranded trefoil on the right is an essential torus in the exterior of the theta graph.

an essential torus in its exterior. It was created by isotoping a Kinoshita–Wolcott graph to the position required to apply the clasping move via an isotopy which moved a point on one of the edges around a trefoil knot. A graph with an essential torus in its exterior is neither hyperbolic nor a trivial graph.

4. New examples of Brunnian theta graphs

Besides the Kinoshita graph and vertex sums of the Kinoshita graph with itself, are there other hyperbolic Brunnian theta graphs? In this section, we give a new infinite family of examples of diagrams of spatial theta curves. In the next section we will prove that infinitely many of them are also nontrivial. These examples have the property that they are of low bridge number. Forthcoming work of Taylor and Tomova will show that this implies that these graphs are vertex-prime. Furthermore, since they are low bridge number it is likely that they are hyperbolic. [Section 6](#) concludes this paper with some questions for further research.

Let $Q = \{(x, y, z) \in \mathbb{R}^3 : -1 \leq z \leq 1\}$. A pure n -braid representative consists of n arcs (called strands) in Q such that the i -th strand has endpoints at $(i, 0, \pm 1)$ and for each arc projecting onto the z -axis is a strictly monotonic function. Two pure n -braid representatives are equivalent if there is an isotopy in Q from one to the other which fixes ∂Q . The set of equivalence classes is $\text{PB}(n)$. Two pure n -braid representatives can be “stacked” to create another pure n -braid representative by placing one on top of the other and then scaling in the z -direction by $\frac{1}{2}$. Applying this operation to equivalence classes we obtain the group operation for $\text{PB}(n)$. If σ and ρ are elements of $\text{PB}(n)$, we let $\sigma\rho$ denote the braid having a representative created by stacking a representative for σ on top of a representative for ρ and then scaling in the z -direction by $\frac{1}{2}$.

Let $\phi : \text{PB}(4) \rightarrow \text{PB}(2)$ be the homomorphism which forgets the last two strands. For each $A \in \ker \phi$ we will construct a family $G(A, t_1, t_2)$ for $t_1, t_2 \in \mathbb{Z}$ of theta graphs with the Brunnian property. We will construct $G(A, t_1, t_2)$ by placing braids into the boxes in the template shown in [Figure 5](#). Let $\rho : \text{PB}(4) \rightarrow \text{PB}(6)$ be a monomorphism which “doubles” each of the last two strands of $A \in \text{PB}(4)$ (i.e., in $\rho(A)$ the fourth strand is parallel to the third and the sixth strand is parallel to the fifth). For a given $A \in \ker \phi$, we place $\rho(A)$ into the top braid box of [Figure 5](#). The shading indicates the doubled strands. There is more than one choice for the monomorphism ρ , as the doubled strands may be allowed to twist around each other (i.e., we may vary the framing). We will always choose the homomorphism determined by the “blackboard framing” (i.e., in our diagram the doubled strands are two edges of a rectangle embedded in the plane). Into the second and fourth boxes from the top we place the braid A^{-1} . In the third box we place the element from $\text{PB}(2)$ consisting of two strands with t_1 full twists. We use the convention

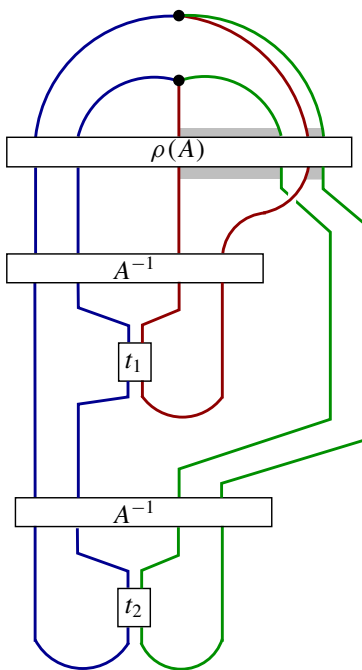

Figure 5. The template for the graph G_A .

that, giving the strands a downward orientation, if $t_1 > 0$ there are $2|t_1|$ left-handed crossings and if $t_1 < 0$ there are $2|t_1|$ right-handed twists. Into the bottom box we place t_2 full twists, using the same orientation convention as for t_1 .

Considering the plane of projection in Figure 5 as the xy plane, the plane Π perpendicular to the plane of projection and cutting between the second and third boxes from the top functions as a “bridge plane” for $G(A, t_1, t_2)$. Observe that if we measure the height of a point $x \in G(A, t_1, t_2)$ by its projection onto the y -axis, each edge of $G(A, t_1, t_2)$ has a single local minimum for the height function and no other critical points in its interior. This implies that Π cuts $G(A, t_1, t_2)$ into trees with special properties. The two trees above Π have a single vertex which is not a leaf and their union is isotopic (relative to endpoints) into Π . The three trees below Π are all edges (i.e., each is a tree with two vertices and single edge) and their union can be isotoped relative to the endpoints into Π . Thus, Π is a bridge plane for $G(A, t_1, t_2)$ and $|G(A, t_1, t_2) \cap \Pi| = 6$. We might, therefore, say that $G(A, t_1, t_2)$ has “bridge number at most 3”. The precise definition of bridge number for theta graphs has been a matter of dispute (see [Motohashi 2000]). The forthcoming paper of Taylor and Tomova explores bridge number for spatial graphs in detail.

Theorem 4.1. *For each $A \in \ker \phi$ and $t_1, t_2 \in \mathbb{Z}$, the graph $G(A, t_1, t_2)$ has the Brunnian property.*

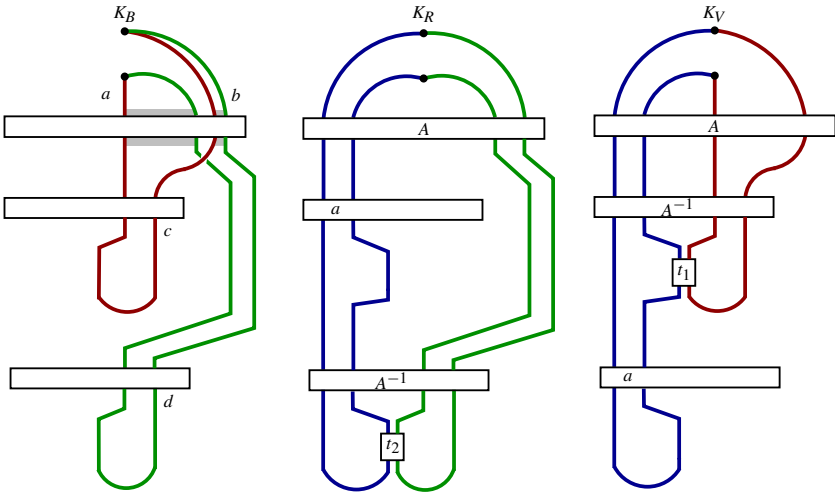

Figure 6. The constituent knots K_B , K_R , and K_V of $G(A, t_1, t_2)$.

Proof. The proof is easy and diagrammatic. Color the edges coming out of the top vertex in the diagram in Figure 5 by blue, red, and verdant from left to right. Then the edges entering into the bottom vertex are also blue, red, and verdant from left to right. In Figure 6, we have the knots K_B , K_R , and K_V obtained by removing the blue, red, and verdant edges respectively. Observe that the top braid box of K_R and K_V contains the braid A . In each of the diagrams for K_B , K_R , and K_V we have labeled certain portions with lower case letters. We now explain those regions and why each diagram can be simplified to the standard diagram for the unknot.

Consider the diagram for K_B . Since the third and fourth strands of the top braid box of $G(A, t_1, t_2)$ are parallel, we may untwist the diagram at region a and at region b . At regions c and d , we may also untwist at the minima. The end result is a diagram of a knot having a single crossing. The knot K_B must, therefore, be the unknot.

Consider the diagram for K_R . At region a we have the trivial 2-braid since $A \in \ker \phi$. The braid A in the top braid box may therefore be canceled with the braid A^{-1} in the third-from-the-top braid box. Finally, we may untwist the t_2 full twists in the final braid box to arrive at the standard diagram for the unknot.

Consider the diagram for K_V . The braids A and A^{-1} cancel, at which point we may untwist the t_1 full twists. We may also untwist at region a . Thus, K_V is also the unknot. □

Given a graph $G(A, t_1, t_2)$ we can construct other theta graphs of bridge number at most 3 with the Brunnian property by using the clasping technique in such a way that we do not introduce any additional critical points in the interior of any edge, so it is highly unlikely that the template in Figure 5 encompasses all possible theta graphs of bridge number at most 3 with the Brunnian property. On the other

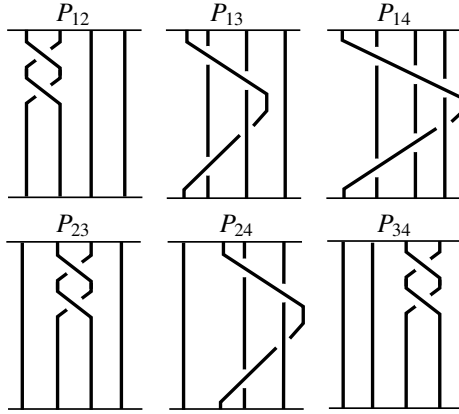

Figure 7. The generators for $PB(4)$.

hand, there are infinitely many braids A such that $G(A, 0, 0)$ is a diagram of the trivial theta graph (see below), so the question as to what braids in $\ker \phi$ produce nontrivial theta graphs is somewhat subtle.

5. Braids producing Brunnian theta graphs

In this section we produce an infinite family of braids $A \in \ker \phi \subset PB(4)$ such that there exists t_1 such that $G(A, t_1, t_2)$ is Brunnian for all t_2 . To describe the braids A more precisely, we recall the standard generating set for $PB(4)$. For $i, j \in \{1, 2, 3, 4\}$ with $i < j$, let P_{ij} denote the element of $PB(4)$ obtained by “looping” the i -th strand around the j -th strand, as in Figure 7. Observe that P_{23}^k produces a twist box in the second and third strands with k full twists, using the sign convention from earlier.

There are nontrivial braids A for which $G(A, 0, 0)$ is trivial. For example, for every n, t_1 , and t_2 , the graphs $G(P_{23}^n, t_1, t_2)$ are all trivial. To show that there are infinitely many braids producing nontrivial graphs, let $A_n = P_{23}^{-n} P_{13}$ and for $m \in \mathbb{Z}$, let $\Gamma(n, m) = G(A_n, -n, m)$ (see Figure 8 for a diagram of A_2).

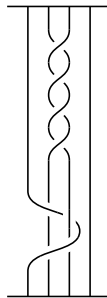

Figure 8. The braid A_2 .

Theorem 5.1. *For all $n, m \in \mathbb{Z}$, the graph $\Gamma(n, m)$ is a Brunnian theta graph. Furthermore, suppose that for a given $(n, m) \in \mathbb{Z} \times \mathbb{Z}$, the set $S(n, m) \subset \mathbb{Z} \times \mathbb{Z}$ has the properties that if $(a, b) \in S(n, m)$ then $\Gamma(a, b)$ is isotopic to $\Gamma(n, m)$ and if $(a, b), (a', b') \in S(n, m)$ are distinct, then $a + b \neq a' + b'$. Then $S(n, m)$ has at most three distinct elements. In particular, there exist infinitely many $n \in \mathbb{Z}$ such that the graphs $\Gamma(n, 0)$ are pairwise distinct Brunnian theta graphs.*

Before proving the theorem, we establish some background. A *handlebody* is the regular neighborhood of a finite graph embedded in S^3 and its *genus* is the genus of the boundary surface. We will be considering genus 2 handlebodies. A disc D properly embedded in a handlebody H whose boundary does not bound a disc in ∂H is called an *essential disc* in H . If H has genus 2 and if $D \subset H$ is an essential nonseparating disc, the space $H \setminus \mathring{\eta}(D)$ is homeomorphic to $S^1 \times D^2$. A knot isotopic to the core of that solid torus is called a *constituent knot* of H . If $G \subset S^3$ is a spatial theta graph and if $H = \eta(G)$, then a disc $D \subset H$ intersecting an edge e of G exactly once transversally and disjoint from the other edges of G is called a *meridian disc* for e . Thus, if D is a meridian disc for e , then $H \setminus \mathring{\eta}(D)$ is a regular neighborhood of K_e . Observe that if G is a theta graph and if $e \subset G$ is an edge, then any meridian disc D for e is an essential disc in the handlebody $\eta(G)$, as D does not separate $\eta(G)$.

If G and G' are spatial theta graphs such that G is isotopic to G' then the isotopy can be extended to an isotopy of the handlebody $\eta(G)$ to the handlebody $\eta(G')$. Furthermore, if the isotopy takes an edge $e \subset G$ to an edge $e' \subset G'$ then the isotopy takes any meridian disc for e to a meridian disc for e' . On the other hand, an isotopy of $\eta(G)$ to $\eta(G')$ does not necessarily correspond to an isotopy of G to G' . Instead, an isotopy of $\eta(G)$ to $\eta(G')$ corresponds to a sequence of isotopies and “edge slides” of G . An *edge slide* of an edge $e \subset G$ of a graph involves sliding one end of e across edges of G (see [Scharlemann and Thompson 1994]). As in Figure 9, an edge slide of a theta graph may convert a theta graph into a spatial graph that is not a theta graph. Conversely, any sequence of edge slides and isotopies of a graph G corresponds to an isotopy of $\eta(G)$.

Given a spatial theta graph G and an edge e , an essential nonseparating disc E in $\eta(G)$ is *along* e if it lies in a regular neighborhood of e , is not a meridian of e , if there is a meridian disc D for e such that $|D \cap E|$ (the number of components of $D \cap E$) is equal to 1. Observe that if E is along e , then $\eta(G) \setminus \mathring{\eta}(E)$ is a solid torus

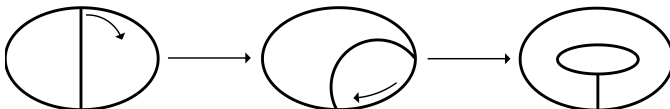

Figure 9. An edge slide converting a theta graph into a nontheta graph.

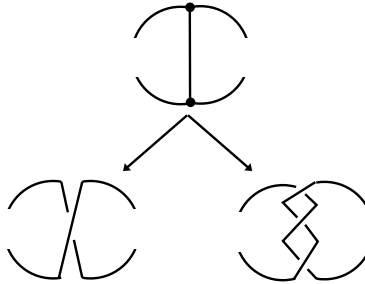

Figure 10. Two ways of unzipping an edge of a spatial theta graph. As is suggested by the picture, the θ -graph may be embedded in S^3 in some, potentially complicated, way. We do, however, require that the unzipping produce a knot and not a 2-component link.

since E is nonseparating. If E is along e , then we say that the knot which is the core of $\eta(G) \setminus \hat{\eta}(E)$ is obtained by *unzipping* the edge e . Figure 10 shows two different ways of unzipping an edge. The proof of Lemma 5.5 will also be helpful in understanding the relationship between the definition of unzipping given above and the diagrams in Figure 10. The term “unzipping” is taken from Bar-Natan and D. Thurston (see, for example, [Thurston 2002]). It is a form of an operation also known as “attaching a band” to K_e or “distance 1 rational tangle replacement” on K_e .

Since an isotopy of a handlebody in S^3 to another handlebody takes discs in the first handlebody to discs in the second and preserves the number of intersections between discs, we have:

Lemma 5.2. *Suppose that G and G' are isotopic spatial theta graphs such that the isotopy takes an edge e of G to an edge e' of G' . If $K \subset S^3$ is a knot obtained by unzipping the edge e , then there is a knot $K' \subset S^3$ which is obtained by unzipping the edge e' such that K and K' are isotopic.*

Rational tangles. The key step in our proof of Theorem 5.1 is to show that unzipping $\Gamma(n, m)$ does not produce any knot that can be obtained by unzipping a trivial theta graph along one of its edges. Analyzing the knots we do get will show, as a by-product, that infinitely many of the $\Gamma(n, m)$ are distinct. We use rational tangles to analyze our knots.

A *rational tangle* is a pair (B, τ) where B is a 3-ball and $\tau \subset B$ is a properly embedded pair of arcs which are isotopic into ∂B relative to their endpoints. We mark the points $\partial\tau \subset \partial B$ by NW, NE, SW, and SE as in Figure 11. Two rational tangles (B, τ) and (B, τ') are *equivalent* if there is a homeomorphism of pairs $h : (B, \tau) \rightarrow (B', \tau')$ which fixes ∂B pointwise. Conway [1970] showed how to associate a rational number $r \in \mathbb{Q} \cup \{1/0\}$ to each rational tangle in such a way

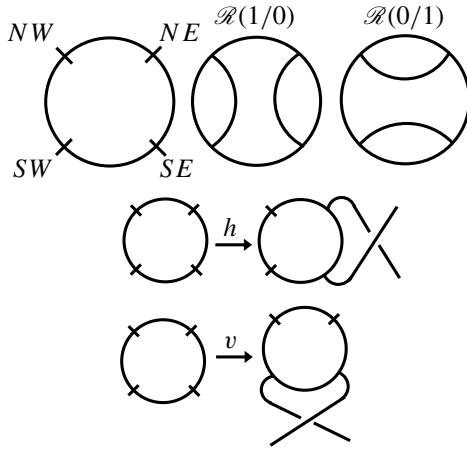

Figure 11. The basic transformations of a rational tangle.

that two rational tangles are equivalent if and only if they have the same associated rational number. We briefly explain the association, using the conventions of [Gordon 2009, Lecture 4]. Using the 3-ball with marked points as in Figure 11, we let the rational tangle $\mathcal{R}(0/1)$ consist of a pair of horizontal arcs having no crossings and we associate to it the rational number $0 = 0/1$. The rational tangle $\mathcal{R}(1/0)$, consisting of a pair of vertical arcs having no crossings, is given the rational number $1/0$ (thought of as a formal object). Let $h : B \rightarrow B$ and $v : B \rightarrow B$ be the horizontal and vertical half-twists, as shown in Figure 11. Observe that the rational tangle $v^{2k} \mathcal{R}(0/1)$ is a twist box with $-k$ full twists, using the orientation convention from earlier.

Let a_1, a_2, \dots, a_k be a finite sequence of integers such that $a_2, \dots, a_k \neq 0$. Let $\mathcal{R}(a_1, \dots, a_k)$ be the rational tangle defined by

$$\mathcal{R}(a_1, a_2, \dots, a_k) = \begin{cases} h^{a_1} v^{a_2} \dots h^{a_{k-1}} v^{a_k} \mathcal{R}(1/0) & \text{if } k \text{ is even,} \\ h^{a_1} v^{a_2} \dots v^{a_{k-1}} h^{a_k} \mathcal{R}(0/1) & \text{if } k \text{ is odd.} \end{cases}$$

We assign the rational number

$$\frac{p}{q} = a_1 + \frac{1}{a_2 + \frac{1}{a_3 + \frac{1}{\dots + \frac{1}{a_k}}}}$$

to $\mathcal{R}(a_1, a_2, \dots, a_k)$ and we define $\mathcal{R}(p/q) = \mathcal{R}(a_1, \dots, a_k)$, with p and q relatively prime.

We define the *distance* between two rational tangles $\mathcal{R}(p/q)$ and $\mathcal{R}(p'/q')$ to be $\Delta(p/q, p'/q') = |pq' - p'q|$. Observe that in the 3-ball B , there is a disc

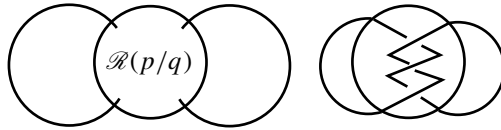

Figure 12. On the left is the denominator closure $\mathcal{D}(\mathcal{R}(p/q))$ of the rational tangle $\mathcal{R}(p/q)$. On the right, we see that the right-handed trefoil is the denominator closure of the rational tangle $\mathcal{R}(1/3)$.

$D \subset B$ such that ∂D partitions the marked points $\{NW, SW, NE, SE\}$ into pairs and which separates the strands of a given rational tangle $\mathcal{R}(p/q)$. Indeed, given a disc $D \subset B$ whose boundary partitions the marked points into pairs, there is a rational tangle $\mathcal{R}(p/q)$ (unique up to equivalence of rational tangles) such that D separates the strands of $\mathcal{R}(p/q)$. We call D a *defining disc* for $\mathcal{R}(p/q)$. If D is a defining disc for $\mathcal{R}(p/q)$ and D' is a defining disc for $\mathcal{R}(p'/q')$ such that, out of all such discs, D and D' have been isotoped to intersect minimally, then it is not difficult to show that $\Delta(p/q, p'/q') = |D \cap D'|$ (i.e., the distance between the rational tangles is equal to the minimum number of arcs of intersection between defining discs).

From a rational tangle $\mathcal{R}(p/q)$ we can create the unknot or a 2-bridge knot or link $\mathcal{K}(p/q) = \mathcal{D}(\mathcal{R}(p/q))$ by taking the so-called *denominator closure* \mathcal{D} of $\mathcal{R}(p/q)$ where we attach the point NW to the point SW and the point NE to the point SE by an unknotted pair of arcs lying in the exterior of B , as in [Figure 12](#). Thus, the right-handed trefoil is $\mathcal{K}(1/3)$ and the left-handed trefoil is $\mathcal{K}(-1/3)$.

Theorem 5.3 [[Schubert 1956](#)]. *Let $p/q, p'/q' \in \mathbb{Q} \cup \{1/0\}$ with $q, q' > 0$ and the pairs p, q and p', q' relatively prime. The knot or link $\mathcal{K}(p/q)$ is isotopic (as an unoriented knot or link) in S^3 to the knot or link $\mathcal{K}(p'/q')$ if and only if $q = q'$ and either $p \equiv p' \pmod q$ or $pp' \equiv 1 \pmod q$.*

Remark 5.4. For more on Schubert’s theorem, see [[Cromwell 2004](#), Theorem 8.7.2] or [[Kauffman and Lambropoulou 2003](#), Theorem 3]. Since we are using the denominator closure of rational tangles our convention and the statement of Schubert’s theorem differ from the usual convention and statement by exchanging numerators and denominators. See the discussion following Theorem 3 of [[Kauffman and Lambropoulou 2003](#)].

Unzipping the trivial graph. Since we want to show that each graph in a certain family of graphs is nontrivial, the following will be useful.

Lemma 5.5. *Suppose that $G \subset S^3$ is the trivial theta graph and that K is a knot obtained by unzipping an edge e of G . Then either K is the unknot or there exists $k \in \mathbb{Z}$, odd such that K is a $(2, k)$ torus knot.*

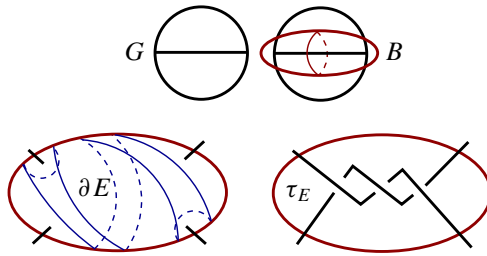

Figure 13. Upper Left: The trivial graph G . Upper Right: the ball $B = \eta(e)$. Lower Left: A disc E . Lower Right: The rational tangle $\mathcal{R}(-3)$ with defining disc E .

Proof. Let G be the trivial theta graph and let $e \subset G$ be an edge. Observe that there is an isotopy of G which interchanges any two edges. Thus, we may consider G to be the union of the unit circle in \mathbb{R}^2 with a horizontal diameter e , as in Figure 13. We may consider the neighborhood $\eta(e)$ of e as a 3-ball B with a vertical disc as a meridian disc for e . The graph G intersects B in four punctures, which we label NW, NE, SW, and SE as usual. Take D to be the meridian disc for e and let $E \subset B$ be a disc with boundary an essential curve in $\partial B \setminus G$, which cannot be isotoped to be disjoint from D , and for which $|D \cap E| = 1$. Observe that D is the defining disc for the rational tangle $\mathcal{R}(1/0)$. If E is the defining disc for the rational tangle $\mathcal{R}(k/\ell)$, then

$$1 = \Delta(1/0, k/\ell) = |\ell|.$$

Consequently, the rational tangle $\mathcal{R}(k/1)$ consists of k horizontal half twists. Thus the knot which is the core of $\eta(G) \setminus \mathring{\eta}(E)$ is a $(2, \pm k)$ twist knot. \square

The following corollary follows immediately from Lemmas 5.2 and 5.5.

Corollary 5.6. *Suppose that $G \subset S^3$ is a trivial spatial theta graph. Then for all edges $e \subset G$ and for any knot K obtained by unzipping e there exists an odd $k \in \mathbb{Z}$ such that K is a $(2, k)$ torus knot, i.e., $\mathcal{K}(1/k)$.*

Proof of Theorem 5.1. The proof is similar in spirit to [Wolcott 1987, §3]. We do not, however, use Wolcott’s theorem 3.11 as that theorem would require us to work with links, rather than with knots. Potentially, however, a clever use of Wolcott’s theorem would show that a much wider class of braids A create nontrivial graphs $G(A, t_1, t_2)$. Our method, however, also allows us, using a result of Eudave-Muñoz [1992] concerning reducible surgeries on strongly invertible knots, to show that we have infinitely many distinct Brunnian theta graphs.

Let $n, m \in \mathbb{Z}$, and let $G = \Gamma(n, m)$. To prove that G is a Brunnian theta graph, by Theorem 4.1, we need only show that G is nontrivial.

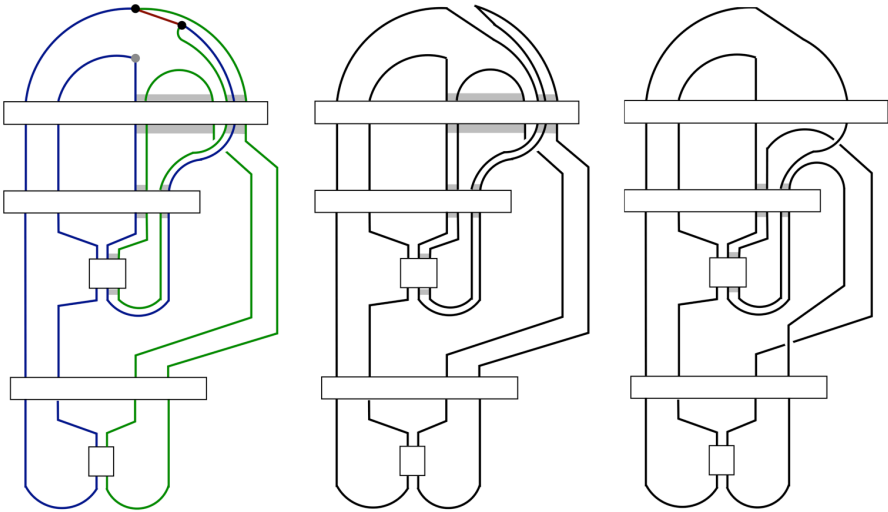

Figure 14. On the left we have isotoped the template so that R has no crossings. The shaded boxes denote doubled strands. In the middle we have unzipped along R using a particular choice of unzipping disc. On the right, we have simplified the unzipped knot by using the parallel strands from the top braid box.

Let v_+ be the upper vertex of G in Figure 5 and let v_- be the lower vertex. Recall that we color the edges of G (from left to right at each vertex) as blue, red, and verdant. Isotope G so that the endpoint of the verdant edge V adjacent to v_- is moved near v_+ by sliding it along the red edge, as on the left of Figure 14. This isotopy creates a diagram of G such that red edge has no crossings. Let K be the knot obtained by unzipping the red edge, as in the middle of Figure 14 (choosing the unzip so that no twists are inserted in the diagram along V). Using the doubled strands in the top braid box, isotope K so that it has the diagram on the right of Figure 14.

Inserting the braid A_n into the template, as specified in Figure 5, our knot K has the diagram on the top left of Figure 15. Let 3_1 be the right-handed trefoil. Now perform the isotopies indicated in Figure 15 to see that K is the connected sum of 3_1 and the knot

$$\mathcal{K}\left(-\frac{3}{6(m+n)+5}\right) = \mathcal{D}(\mathcal{R}(0, -2(m+n) - 1, -1, -1, -1)).$$

Since torus knots are prime, K is not a $(2, k)$ torus knot for any $k \in \mathbb{Z}$ unless $\mathcal{K}(-3/(6(m+n)+5))$ is the trivial knot, that is $\mathcal{K}(-3/(6(m+n)+5)) = \mathcal{K}(1)$.

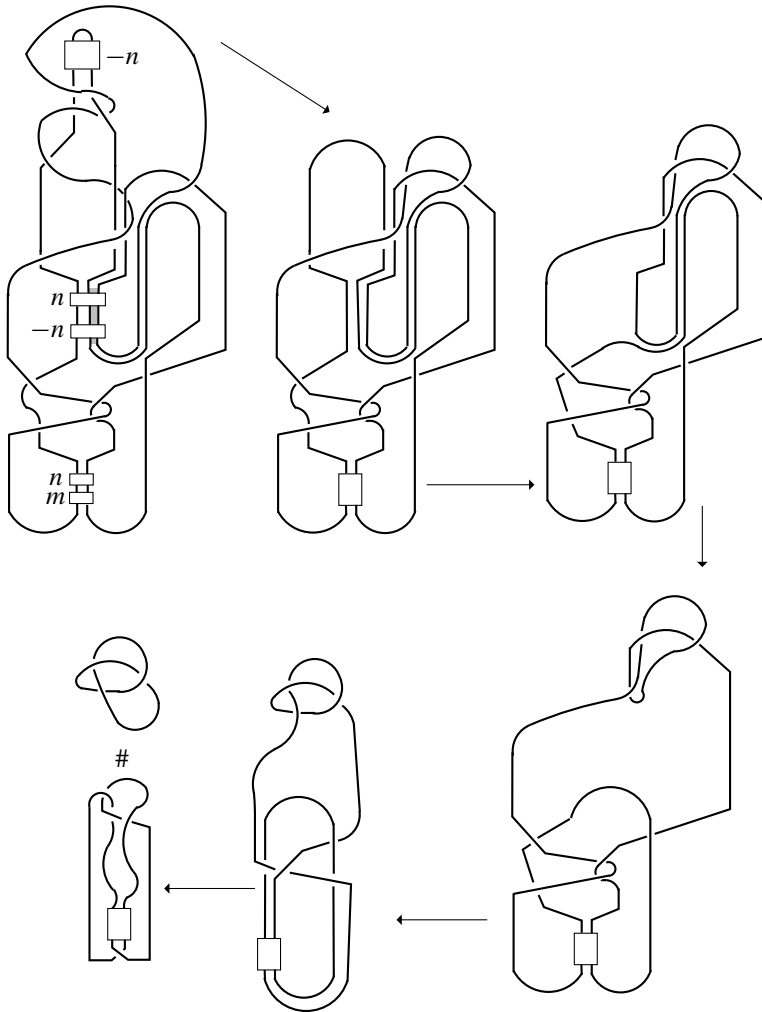

Figure 15. The isotopies showing that K is the connected sum of a right handed trefoil and $\mathcal{K}(-3/(6(m+n)+5))$. In the first step we combine the lower two twist boxes into a single twist box with $m+n$ full twists.

By Schubert’s theorem, this can only happen if $6(m+n)+5=1$, an impossibility. Thus, each $\Gamma(n,m)$ is a Brunnian theta graph.

To prove the part about distinctness, we use a theorem of Eudave-Muñoz [1992] and the Montesinos trick [Montesinos 1975] (see also [Gordon 2009] for a nice explanation). We begin by showing:

Claim. *If $a+b \neq a'+b'$, then there is no isotopy from $\Gamma(a',b')$ to $\Gamma(a,b)$ which takes the red edge of $\Gamma(a',b')$ to the red edge of $\Gamma(a,b)$.*

We prove this by contradiction. Let $B \subset S^3$ be a regular neighborhood of the red edge of $\Gamma(a, b)$ and let $W = S^3 \setminus \overset{\circ}{B}$ be the complementary 3–ball. Mark the points of $\Gamma(a, b) \cap \partial B$ by NE, SE, NW, SW so that a meridian disc for the red edge of $\Gamma(a, b)$ corresponds to the rational tangle $\mathcal{R}(1/0)$ and the disc E , along which we unzip $\Gamma(a, b)$ to produce $K = 3_1\#\mathcal{K}(-3/(6(a+b)+5))$, corresponds to the rational tangle $\mathcal{R}(0/1)$. Let $\tau = K \cap W$.

The isotopy of $\Gamma(a, b)$ to $\Gamma(a', b')$ takes B to a regular neighborhood B' of the red edge of $\Gamma(a', b')$. In B' there is a disc D' which is along the red edge of $\Gamma(a', b')$ such that unzipping $\Gamma(a', b')$ along D' produces $(3_1\#\mathcal{K}(-3/(6(a'+b')+5)))$. Reversing the isotopy, takes D' to a disc $D \subset B$ which is along e . Let $\mathcal{R}(p/q)$ be the rational tangle corresponding to D . The knot $K' = \tau \cup \mathcal{R}(p/q)$ is isotopic to the result of unzipping $\Gamma(a', b')$ along D' and so $K' = (3_1\#\mathcal{K}(-3/(6(a'+b')+5)))$. If the disc D is isotopic to the disc E , the rational tangles $\mathcal{R}(p/q)$ and $\mathcal{R}(0/1)$ are equivalent. In which case, K is isotopic to K' . But this implies that $a + b = a' + b'$, a contradiction. Thus, the rational tangles $\mathcal{R}(0/1)$ and $\mathcal{R}(p/q)$ are distinct (since the discs are not isotopic).

Since $\tau \cup \mathcal{R}(1/0)$ is the unknot in S^3 , the double branched cover of W over τ is the exterior of a strongly invertible knot $L \subset S^3$. Since $K = \tau \cup \mathcal{R}(0/1)$ and $K' = \tau \cup \mathcal{R}(p/q)$ are composite knots, the double branched covers of S^3 over K and K' are reducible. In particular there are distinct Dehn surgeries on L producing reducible manifolds. The surgeries are distinct since $\mathcal{R}(0/1)$ is not equivalent to $\mathcal{R}(p/q)$. However this contradicts that the Cabling Conjecture holds for strongly invertible knots [Eudave-Muñoz 1992, Theorem 4]. Proving the claim. \square

For a pair $(n, m) \in \mathbb{Z} \times \mathbb{Z}$, let $S(n, m) \subset \mathbb{Z} \times \mathbb{Z}$ be a subset with the property that for all $(a, b) \in S(n, m)$, the graph $\Gamma(a, b)$ is isotopic to the graph $\Gamma(n, m)$ and which has the property that for all pairs $(a, b), (a', b') \in S(n, m)$ if $a + b = a' + b'$, then $(a, b) = (a', b')$. Observe that $(n, m) \in S(n, m)$. We will show that for all $(n, m) \in \mathbb{Z} \times \mathbb{Z}$, the set $S(n, m)$ has at most three elements.

Suppose, for a contradiction, that there exists (n, m) such that $S(n, m)$ has at least 4 distinct elements $(a_1, b_1), (a_2, b_2), (a_3, b_3), (n, m)$. Each isotopy between any two graphs $\{\Gamma(a_1, b_1), \Gamma(a_2, b_2), \Gamma(a_3, b_3), \Gamma(n, m)\}$ induces a permutation of the set $\{B, R, V\}$ of blue, red, and verdant edges. For each $i \in \{1, 2, 3\}$, choose an isotopy f_i from $\Gamma(n, m)$ to $\Gamma(a_i, b_i)$ and let σ_i be the induced permutation of $\{B, R, V\}$. By the claim and the definition of $S(n, m)$ no σ_i fixes R and, whenever $i \neq j$, the permutation $\sigma_i \sigma_j^{-1}$ also does not fix R . Hence, $\sigma_i \neq \sigma_j$ if $i \neq j$. In the permutations of the set $\{B, R, V\}$, there are exactly four that do not fix R and of those, two are transpositions. Thus, without loss of generality, we may assume that σ_1 is a transposition.

Suppose that σ_1 is the transposition $(B, R, V) \rightarrow (B, V, R)$. Since neither $\sigma_2 \sigma_1^{-1}$ nor $\sigma_3 \sigma_1^{-1}$ fixes R and since $\sigma_2 \neq \sigma_3$, the permutations σ_2 and σ_3 are the two permutations taking R to B . But then the composition $\sigma_2 \sigma_3^{-1}$ takes R to R , a contradiction.

The case when σ_1 is the transposition $(B, R, V) \rightarrow (R, B, V)$ similarly gives rise to a contradiction. Thus, for every $(n, m) \in \mathbb{Z} \times \mathbb{Z}$, the set $S(n, m)$ has at most three elements (including (n, m)).

Define a sequence (n_i) in \mathbb{Z} recursively. Let $n_1 \in \mathbb{Z}$ and recall that, by the above, $\Gamma(n_1, 0)$ is a Brunnian theta graph. Assume we have defined n_1, \dots, n_i so that the graphs $\Gamma(n_j, 0)$ for $1 \leq j \leq i$ are pairwise nonisotopic Brunnian theta graphs. Let $P \subset \mathbb{Z}$ be such that $n \in P$ if and only if $\Gamma(n, 0)$ is isotopic to $\Gamma(n_j, 0)$ for some $1 \leq j \leq i$. Since for each j with $1 \leq j \leq i$ there are at most 3 elements n of \mathbb{Z} such that $\Gamma(n, 0)$ is isotopic to $\Gamma(n_j, 0)$, the set P is finite. Hence, we may choose $n_{i+1} \in \mathbb{Z} \setminus P$. Thus, we may construct a sequence (n_i) in \mathbb{Z} so that the graphs $\Gamma(n_i, 0)$ are pairwise disjoint Brunnian theta graphs. \square

6. Questions and conjectures

Using the software [Heard 2013], and a lot of patience, it is possible to compute (approximations to) hyperbolic volumes for some of the graphs $G(A, t_1, t_2)$. Our explorations suggest that “most” of the braids $A \in \text{PB}(4)$ produce hyperbolic Brunnian theta graphs for all $t_1, t_2 \in \mathbb{Z}$. Indeed, the software suggests that for a “sufficiently complicated” braid $A \in \text{PB}(4)$, and for fixed t_1, t_2 the volume of the exterior of $G(A^n, t_1, t_2)$ grows linearly in n . This is to be contrasted with the belief, based on the Thurston 2π theorem, that for a fixed A and t_1 , the volumes of $G(A, t_1, t_2)$ will converge as $t_2 \rightarrow \infty$. Furthermore, calculations of hyperbolic volumes using Orb indicate that the graphs $\Gamma(n, m)$ of Theorem 5.1 are likely not Kinoshita–Wolcott graphs. Since the calculations of hyperbolic volume are only approximate and since we can only calculate the volumes of finitely many of the graphs, we do not have a proof of that fact.

These investigations raise the following questions:

- (1) For what braids $A \in \ker \phi$ is $G(A, 0, 0)$ a Brunnian theta graph?
- (2) Can Litherland’s Alexander polynomial (or some other algebraic invariant) prove that there are infinitely many braids $A \in \ker \phi$ such that $G(A, t_1, t_2)$ is a Brunnian theta graph for some $t_1, t_2 \in \mathbb{Z}$?
- (3) Is any one of the Brunnian graphs $\Gamma(n, m)$ a Kinoshita–Wolcott graph?
- (4) Are there infinitely many braids A such that the graph $G(A, 0, 0)$ is a Brunnian theta graph which is not a Kinoshita–Wolcott graph? We conjecture the answer to be yes.
- (5) For what $A \in \ker \phi$ and $t_1, t_2 \in \mathbb{Z}$ is $G(A, t_1, t_2)$ a hyperbolic Brunnian theta graph? We conjecture that whenever $G(A, t_1, t_2)$ is a Brunnian theta graph, then it is hyperbolic.

- (6) Is it true that if $G(A, t_1, t_2)$ is hyperbolic then $G(A^n, t_1, t_2)$ is hyperbolic for all $n \in \mathbb{N}$? Does the hyperbolic volume of the exterior of $G(A^n, t_1, t_2)$ grow linearly in n ?

Acknowledgements

We thank the attendees at the 2013 Spatial Graphs conference for helpful discussions, particularly Erica Flapan and Danielle O’Donnol. We are also grateful to Ryan Blair, Ilya Kofman, Jessica Purcell, and Maggy Tomova for helpful conversations. This research was partially funded by Colby College.

References

- [Calcut and Metcalf-Burton 0] J. S. Calcut and J. R. Metcalf-Burton, “Double branched covers of theta-curves”, *J. Knot Theory Ramifications* **0**:0 (0), 1650046.
- [Conway 1970] J. H. Conway, “An enumeration of knots and links, and some of their algebraic properties”, pp. 329–358 in *Computational problems in abstract algebra* (Oxford, 1967), edited by J. Leech, Pergamon, Oxford, 1970. [MR 0258014](#) [Zbl 0202.54703](#)
- [Cromwell 2004] P. R. Cromwell, *Knots and links*, Cambridge University Press, 2004. [MR 2107964](#) [Zbl 1066.57007](#)
- [Eudave-Muñoz 1992] M. Eudave-Muñoz, “Band sums of links which yield composite links. The cabling conjecture for strongly invertible knots”, *Trans. Amer. Math. Soc.* **330**:2 (1992), 463–501. [MR 1112545](#) [Zbl 0778.57004](#)
- [Gordon 2009] C. Gordon, “Dehn surgery and 3-manifolds”, pp. 21–71 in *Low dimensional topology*, edited by T. S. Mrowka and P. S. Ozsváth, IAS/Park City Mathematics Series **15**, American Mathematical Society, Providence, RI, 2009. [MR 2503492](#) [Zbl 1194.57003](#)
- [Heard 2013] D. Heard, “Orb”, 2013, <http://www.ms.unimelb.edu.au/~snap/orb.html>.
- [Kauffman and Lambropoulou 2003] L. H. Kauffman and S. Lambropoulou, “On the classification of rational knots”, *Enseign. Math.* (2) **49**:3-4 (2003), 357–410. [MR 2028021](#) [Zbl 1059.57004](#)
- [Kinoshita 1958] S. Kinoshita, “Alexander polynomials as isotopy invariants. I”, *Osaka Math. J.* **10** (1958), 263–271. [MR 0102819](#) [Zbl 0119.38801](#)
- [Kinoshita 1972] S. Kinoshita, “On elementary ideals of polyhedra in the 3-sphere”, *Pacific J. Math.* **42** (1972), 89–98. [MR 0312485](#) [Zbl 0239.55002](#)
- [Litherland 1989] R. Litherland, “The Alexander module of a knotted theta-curve”, *Math. Proc. Cambridge Philos. Soc.* **106**:1 (1989), 95–106. [MR 994083](#) [Zbl 0705.57005](#)
- [Livingston 1995] C. Livingston, “Knotted symmetric graphs”, *Proc. Amer. Math. Soc.* **123**:3 (1995), 963–967. [MR 1273507](#) [Zbl 0829.57004](#)
- [McAtee et al. 2001] J. McAtee, D. S. Silver, and S. G. Williams, “Coloring spatial graphs”, *J. Knot Theory Ramifications* **10**:1 (2001), 109–120. [MR 1822144](#) [Zbl 0998.57009](#)
- [Montesinos 1975] J. M. Montesinos, “Surgery on links and double branched covers of S^3 ”, pp. 227–259 in *Knots, groups, and 3-manifolds: Papers dedicated to the memory of R. H. Fox*, edited by L. P. Neuwirth, Annals of Mathematics Studies **84**, Princeton University Press, 1975. [MR 0380802](#) [Zbl 0325.55004](#)
- [Motohashi 2000] T. Motohashi, “2-bridge θ -curves in S^3 ”, *Topology Appl.* **108**:3 (2000), 267–276. [MR 1794559](#)

- [Scharlemann 1992] M. Scharlemann, “Some pictorial remarks on Suzuki’s Brunnian graph”, pp. 351–354 in *Topology ’90* (Columbus, OH, 1990), edited by B. Apanasov et al., Ohio State University Mathematical Research Institute Publications **1**, de Gruyter, Berlin, 1992. [MR 1184420](#) [Zbl 0772.57005](#)
- [Scharlemann and Thompson 1994] M. Scharlemann and A. Thompson, “Thin position and Heegaard splittings of the 3-sphere”, *J. Differential Geom.* **39**:2 (1994), 343–357. [MR 1267894](#) [Zbl 0820.57005](#)
- [Schubert 1956] H. Schubert, “Knoten mit zwei Brücken”, *Math. Z.* **65** (1956), 133–170. [MR 0082104](#) [Zbl 0071.39002](#)
- [Simon and Wolcott 1990] J. K. Simon and K. Wolcott, “Minimally knotted graphs in S^3 ”, *Topology Appl.* **37**:2 (1990), 163–180. [MR 1080350](#) [Zbl 0723.57008](#)
- [Thurston 1997] W. P. Thurston, *Three-dimensional geometry and topology*, vol. 1, edited by S. Levy, Princeton Mathematical Series **35**, Princeton University Press, 1997. [MR 1435975](#) [Zbl 0873.57001](#)
- [Thurston 2002] D. P. Thurston, “The algebra of knotted trivalent graphs and Turaev’s shadow world”, pp. 337–362 in *Invariants of knots and 3-manifolds* (Kyoto, 2001), edited by T. Ohtsuki et al., Geometry & Topology Monographs **4**, (GTP), Coventry, 2002. [MR 2048108](#) [Zbl 1163.57301](#)
- [Wolcott 1987] K. Wolcott, “The knotting of theta curves and other graphs in S^3 ”, pp. 325–346 in *Geometry and topology: manifolds, varieties, and knots* (Athens, GA, 1985), edited by C. McCrory and T. Shifrin, Lecture Notes in Pure and Applied Mathematics **105**, Dekker, New York, NY, 1987. [MR 873302](#) [Zbl 0613.57003](#)

Received: 2015-08-17

Revised: 2015-10-20

Accepted: 2015-10-22

- byoungwookjang@gmail.com *Department of Mathematics and Statistics, Colby College
c/o Scott Taylor, Waterville, ME 04901-8858, United States*
- abkronau@colby.edu *Department of Mathematics and Statistics, Colby College,
Waterville, ME 04901-8858, United States*
- luitelpratap@gmail.com *Department of Mathematics and Statistics, Colby College
c/o Scott Taylor, Waterville, ME 04901-8858, United States*
- demedici@colby.edu *Department of Mathematics and Statistics, Colby College,
Waterville, ME 04901-8858, United States*
- scott.taylor@colby.edu *Department of Mathematics and Statistics, Colby College,
5832 Mayflower Hill, Waterville, ME 04901-8858,
United States*
- zupan@unl.edu *Department of Mathematics, University of Nebraska-Lincoln,
1400 R Street, Lincoln, NE 68588, United States*

INVOLVE YOUR STUDENTS IN RESEARCH

Involve showcases and encourages high-quality mathematical research involving students from all academic levels. The editorial board consists of mathematical scientists committed to nurturing student participation in research. Bridging the gap between the extremes of purely undergraduate research journals and mainstream research journals, *Involve* provides a venue to mathematicians wishing to encourage the creative involvement of students.

MANAGING EDITOR

Kenneth S. Berenhaut Wake Forest University, USA

BOARD OF EDITORS

Colin Adams	Williams College, USA	Suzanne Lenhart	University of Tennessee, USA
John V. Baxley	Wake Forest University, NC, USA	Chi-Kwong Li	College of William and Mary, USA
Arthur T. Benjamin	Harvey Mudd College, USA	Robert B. Lund	Clemson University, USA
Martin Bohner	Missouri U of Science and Technology, USA	Gaven J. Martin	Massey University, New Zealand
Nigel Boston	University of Wisconsin, USA	Mary Meyer	Colorado State University, USA
Amarjit S. Budhiraja	U of North Carolina, Chapel Hill, USA	Emil Minchev	Ruse, Bulgaria
Pietro Cerone	La Trobe University, Australia	Frank Morgan	Williams College, USA
Scott Chapman	Sam Houston State University, USA	Mohammad Sal Moslehian	Ferdowsi University of Mashhad, Iran
Joshua N. Cooper	University of South Carolina, USA	Zuhair Nashed	University of Central Florida, USA
Jem N. Corcoran	University of Colorado, USA	Ken Ono	Emory University, USA
Toka Diagana	Howard University, USA	Timothy E. O'Brien	Loyola University Chicago, USA
Michael Dorff	Brigham Young University, USA	Joseph O'Rourke	Smith College, USA
Sever S. Dragomir	Victoria University, Australia	Yuval Peres	Microsoft Research, USA
Behrouz Emamizadeh	The Petroleum Institute, UAE	Y.-F. S. Pétermann	Université de Genève, Switzerland
Joel Foisy	SUNY Potsdam, USA	Robert J. Plemmons	Wake Forest University, USA
Erin W. Fulp	Wake Forest University, USA	Carl B. Pomerance	Dartmouth College, USA
Joseph Gallian	University of Minnesota Duluth, USA	Vadim Ponomarenko	San Diego State University, USA
Stephan R. Garcia	Pomona College, USA	Bjorn Poonen	UC Berkeley, USA
Anant Godbole	East Tennessee State University, USA	James Propp	U Mass Lowell, USA
Ron Gould	Emory University, USA	József H. Przytycki	George Washington University, USA
Andrew Granville	Université Montréal, Canada	Richard Rebarber	University of Nebraska, USA
Jerrold Griggs	University of South Carolina, USA	Robert W. Robinson	University of Georgia, USA
Sat Gupta	U of North Carolina, Greensboro, USA	Filip Saidak	U of North Carolina, Greensboro, USA
Jim Haglund	University of Pennsylvania, USA	James A. Sellers	Penn State University, USA
Johnny Henderson	Baylor University, USA	Andrew J. Sterge	Honorary Editor
Jim Hoste	Pitzer College, USA	Ann Trenk	Wellesley College, USA
Natalia Hritonenko	Prairie View A&M University, USA	Ravi Vakil	Stanford University, USA
Glenn H. Hurlbert	Arizona State University, USA	Antonia Vecchio	Consiglio Nazionale delle Ricerche, Italy
Charles R. Johnson	College of William and Mary, USA	Ram U. Verma	University of Toledo, USA
K. B. Kulasekera	Clemson University, USA	John C. Wierman	Johns Hopkins University, USA
Gerry Ladas	University of Rhode Island, USA	Michael E. Zieve	University of Michigan, USA

PRODUCTION

Silvio Levy, Scientific Editor

Cover: Alex Scorpan

See inside back cover or msp.org/involve for submission instructions. The subscription price for 2016 is US \$160/year for the electronic version, and \$215/year (+\$35, if shipping outside the US) for print and electronic. Subscriptions, requests for back issues from the last three years and changes of subscribers address should be sent to MSP.

Involve (ISSN 1944-4184 electronic, 1944-4176 printed) at Mathematical Sciences Publishers, 798 Evans Hall #3840, c/o University of California, Berkeley, CA 94720-3840, is published continuously online. Periodical rate postage paid at Berkeley, CA 94704, and additional mailing offices.

Involve peer review and production are managed by EditFLOW[®] from Mathematical Sciences Publishers.

PUBLISHED BY

 **mathematical sciences publishers**
nonprofit scientific publishing

<http://msp.org/>

© 2016 Mathematical Sciences Publishers

involve

2016

vol. 9

no. 5

An iterative strategy for Lights Out on Petersen graphs	721
BRUCE TORRENCE AND ROBERT TORRENCE	
A family of elliptic curves of rank ≥ 4	733
FARZALI IZADI AND KAMRAN NABARDI	
Splitting techniques and Betti numbers of secant powers	737
REZA AKHTAR, BRITTANY BURNS, HALEY DOHRMANN, HANNAH HOGANSON, OLA SOBIESKA AND ZEROTTI WOODS	
Convergence of sequences of polygons	751
ERIC HINTIKKA AND XINGPING SUN	
On the Chermak–Delgado lattices of split metacyclic p-groups	765
ERIN BRUSH, JILL DIETZ, KENDRA JOHNSON-TESCH AND BRIANNE POWER	
The left greedy Lie algebra basis and star graphs	783
BENJAMIN WALTER AND AMINREZA SHIRI	
Note on superpatterns	797
DANIEL GRAY AND HUA WANG	
Lifting representations of finite reductive groups: a character relation	805
JEFFREY D. ADLER, MICHAEL CASSEL, JOSHUA M. LANSKY, EMMA MORGAN AND YIFEI ZHAO	
Spectrum of a composition operator with automorphic symbol	813
ROBERT F. ALLEN, THONG M. LE AND MATTHEW A. PONS	
On nonabelian representations of twist knots	831
JAMES C. DEAN AND ANH T. TRAN	
Envelope curves and equidistant sets	839
MARK HUIBREGTSE AND ADAM WINCHELL	
New examples of Brunnian theta graphs	857
BYOUNGWOOK JANG, ANNA KRONAEUR, PRATAP LUITEL, DANIEL MEDICI, SCOTT A. TAYLOR AND ALEXANDER ZUPAN	
Some nonsimple modules for centralizer algebras of the symmetric group	877
CRAIG DODGE, HARALD ELLERS, YUKIHIDE NAKADA AND KELLY POHLAND	
Acknowledgement	899