

*Pacific
Journal of
Mathematics*

POCHETTE SURGERY OF 4-SPHERE

TATSUMASA SUZUKI AND MOTOO TANGE

Volume 324 No. 2

June 2023

POCHETTE SURGERY OF 4-SPHERE

TATSUMASA SUZUKI AND MOTOO TANGE

Iwase and Matsumoto (2004) defined “pochette surgery” as a cut-and-paste operation on 4-manifolds along a 4-manifold homotopy equivalent to $S^2 \vee S^1$. Suzuki (2022) studied infinitely many homotopy 4-spheres obtained by pochette surgery. We compute the homology of pochette surgery of any homology 4-sphere by using “linking number” of a pochette embedding. We prove that pochette surgery with the trivial cord does not change the diffeomorphism type or gives a Gluck surgery. We also show that there exist pochette surgeries on the 4-sphere with a nontrivial core sphere and a nontrivial cord such that the surgeries give the 4-sphere.

1. Introduction

1A. Pochette surgery. Let D^n be an n -dimensional disk and S^n an n -dimensional sphere. Let P denote the boundary-sum $S^1 \times D^3 \natural D^2 \times S^2$. It is called a *pochette*. Throughout this paper, all manifolds are assumed smooth, and connected, and all maps are smooth. For a manifold M , the open tubular neighborhood for a submanifold $A \subset M$ is denoted by $N(A)$. Let $E(X)$ denote the exterior $M - N(X)$ of a submanifold X in M .

Here we define pochette surgery, which was initially defined by Iwase and Matsumoto in [7]. Let e be an embedding $P \hookrightarrow M$ in a 4-manifold M . Let Q_e denote the image $e(Q)$ of a submanifold Q in P .

Definition 1.1. Let g be a diffeomorphism $g : \partial P \rightarrow \partial E(P_e)$. Gluing $E(P_e)$ and P via g , we construct a manifold $M(e, g) := E(P_e) \cup_g P$. We call this operation a *pochette surgery*. We say that the diffeomorphism g is a *gluing map* for the pochette surgery.

We call the curves $l := S^1 \times \{\text{pt}\}$ and $m := \partial D^2 \times \{\text{pt}\}$ on ∂P a *longitude* and a *meridian* of P , respectively. According to [7, Theorem 2], the diffeomorphism type of $M(e, g)$ is uniquely determined by the following data:

Suzuki is supported by JST SPRING, grant number JPMJSP2106.

Tange is supported by JSPS KAKENHI, grant number 21K03216.

MSC2020: primary 57K45, 57R65; secondary 57K40.

Keywords: 4-manifolds, pochette surgery, handle calculus.

- (i) An embedding $e : P \hookrightarrow M$.
- (ii) A homology class $g_*([m]) \in H_1(\partial E(P_e)) = \mathbb{Z}[m_e] \oplus \mathbb{Z}[l_e]$.
- (iii) A mod 2 framing ϵ around $g(m)$.

The mod 2 framing will be defined in Section 2C. The induced map g_* maps the primitive element $[m]$ in $H_1(\partial P)$ to $p[m_e] + q[l_e]$ in $H_1(\partial E(P_e))$, where p, q are relatively prime integers. Then, we call the element $p/q \in \mathbb{Q} \cup \{\infty\}$ a *slope* of the pochette surgery. Any slope p/q gives an unoriented image $g(m)$ of m . Hence, for some embedding e , the pochette surgery with the slope p/q and the mod 2 framing ϵ is called $(p/q, \epsilon)$ -*pochette surgery* of M and this denotes $M(e, p/q, \epsilon)$. We call the 2-sphere $S := \{\text{pt}\} \times S^2 \subset P$ a *core sphere* of P and the meridian 2-sphere $B := \{\text{pt}\} \times \partial D^3 \subset P$ a *belt sphere* of P .

Consider P as $D^2 \times S^2 \cup h^1$, where h^1 is a 1-handle. In order to embed P into a 4-manifold M , we have only to determine an embedding of $D^2 \times S^2$ and the 1-handle h^1 . First we take an embedding $e : D^2 \times S^2 \hookrightarrow M$.

Definition 1.2 (cord). The 1-handle gives a properly embedded, simple arc in $E(S_e^2)$ by taking the core of h^1 . We call this arc a *cord* here. If a cord is boundary parallel, then the cord is called *trivial*.

1B. Gluck surgery and circle surgery. Let S' be an embedded sphere with a product neighborhood in a 4-manifold M . *Gluck surgery* along S' is an operation $\text{Gl}(S') := E(S') \cup_\varphi (D^2 \times S^2)$, where φ is a diffeomorphism $\partial D^2 \times S^2 \rightarrow \partial N(S') \cong S^1 \times S^2$ which is not homotopy equivalent to the identity. From the construction of pochette surgery, for an embedding $e : P \hookrightarrow M$, any $(\infty, 0)$ -pochette surgery is the trivial surgery and any $(\infty, 1)$ -pochette surgery yields $\text{Gl}(S_e)$. In the case of $(0, \epsilon)$ -pochette surgery, it is an operation $E(l_e) \cup (D^2 \times S^2)$ along the curve $l_e \subset M$. This surgery means that the result is one side of the manifold obtained by attaching 5-dimensional 2-handle on $M \times I$ along l_e . We call the result an S^1 -*surgery* (*circle surgery*). Thus, any pochette surgery with the slope p/q can be regarded as an intermediate between a Gluck surgery and an S^1 -surgery.

Pochette surgery is a generalization of Gluck surgery as mentioned above. Gluck surgery gave exotic nonorientable 4-manifolds in [1]. It is natural to think pochette surgery may give interesting orientable 4-manifolds, possibly exotic 4-spheres and so on. In this article, we focus on pochette surgeries yielding homotopy 4-spheres.

1C. Other results. Since the definition of pochette surgery was done, some people have studied pochette surgery. Murase [9] studied pochette surgeries of the double of P . Let $D(P)$ be the double of P which means $P \cup_{\text{id}} (-P)$. In fact, $D(P)$ is diffeomorphic to $S^1 \times S^3 \# S^2 \times S^2$. Let i_P be the inclusion map $i_P : P \rightarrow D(P)$. He shows the resulting manifold $D(P)(i_P, p/q, \epsilon)$ is diffeomorphic to a rational homology 4-sphere with type L , which is defined in [13].

In the next section, we will share Okawa’s result with readers. He investigates pochette surgeries yielding homotopy 4-spheres with the core sphere ribbon and with the cord trivial. We generalize this in Theorem 1.4.

Suzuki [14] computed the homology of some types of pochette surgeries. These results are generalized in this paper (Proposition 2.5).

Pochette surgery can easily extend to a surgery along $\natural^a S^1 \times D^3 \natural^b D^2 \times S^2$ for some positive integers a, b . This is called *outer surgery* defined in [10]. In the future, we expect to find many exotic 4-manifolds by pochette surgery or outer surgery. See Section 5 for questions for pochette surgery or outer surgery.

1D. Pochette surgery with trivial cord or trivial core sphere. After the definition of pochette surgery by Iwase and Matsumoto, pochette surgeries for embedding of P with trivial cord or trivial core sphere in S^4 have been considered to construct a new type of homotopy 4-spheres.

The case of trivial cord. In this paper, we clarify diffeomorphism types of pochette surgeries of closed 4-manifolds with the trivial cord. Okawa proved the following.

Theorem 1.3 (Okawa [12]). *Let e be an embedding of P into S^4 with the cord trivial. If the core sphere S_e is a ribbon 2-knot, then any pochette surgery $S^4(e, 1/q, \epsilon)$ is diffeomorphic to S^4 for any integer q .*

Here we state the first main theorem.

Theorem 1.4. *Let e be an embedding of P into a closed 4-manifold M with the trivial cord. Then for any integer q , the following holds:*

$$M(e, 1/q, \epsilon) \cong \begin{cases} M, & \epsilon = 0, \\ \text{Gl}(S_e), & \epsilon = 1. \end{cases}$$

The Gluck surgery along any ribbon 2-knot is diffeomorphic to the standard 4-sphere; see, for example, [5]. Hence, Theorem 1.4 implies Theorem 1.3. It is also known that Gluck surgeries of some nonribbon 2-knots give the standard S^4 ; see, for example, [6; 8; 11]. Pochette surgeries for such examples give the standard S^4 .

Theorem 1.4 determines diffeomorphism types of $(1/q, \epsilon)$ -pochette surgeries with the trivial cord. As a corollary, we clarify the diffeomorphism type of any pochette surgery on a homology 4-sphere with the complement of the core sphere homotopically trivial.

Gluck surgery can produce nonorientable exotic 4-manifolds due to Akbulut [1]. Hence, Theorem 1.4 implies that pochette surgery also produces nonorientable exotic 4-manifolds. As in the case of Gluck surgery, it remains uncertain whether pochette surgery has the potential to produce orientable exotic 4-manifolds (Question 5.6).

The case of trivial core sphere. Suzuki [14] proved that several examples of infinitely many homotopy 4-spheres with the trivial core sphere are all diffeomorphic to the standard 4-sphere.

Theorem 1.4 immediately leads to the following theorem. This is a generalization of first author's result.

Theorem 1.5. *Let M be a homology 4-sphere. Let e be an embedding $P \hookrightarrow M$ with $\pi_1(E(S_e)) = \mathbb{Z}$. If a pochette surgery produces a homology 4-sphere, then the result is diffeomorphic to M or $\text{Gl}(S_e)$. In particular suppose M is S^4 and $e : P \hookrightarrow S^4$ is an embedding that the core sphere S_e is the unknot. Then if a pochette surgery by e yields a homology 4-sphere M' , then M' is diffeomorphic to S^4 .*

1E. Pochette surgeries with nontrivial core sphere and cord. Next, we consider several examples of pochette surgeries with nontrivial core sphere and cord.

First, we prove the existence of such an example.

Theorem 1.6. *There exists a pochette embedding $e : P \hookrightarrow S^4$ with a nontrivial core sphere and a nontrivial cord such that the pochette surgery $S^4(e, g)$ is diffeomorphic to S^4 .*

Further, the following theorem gives a sufficient condition for the existence of nontrivial cords whose surgery yielding homotopy 4-sphere is trivialized.

Theorem 1.7. *Let $S \subset S^4$ be any ribbon 2-knot of 1-fusion with $\pi_1(E(S)) \not\cong \mathbb{Z}$. Then there exists a nontrivial cord c in $E(S)$ and an embedding*

$$e : P \rightarrow P_e = N(S) \cup N(c) \subset S^4$$

such that the pochette surgery $S^4(e, p/(p+1), \epsilon)$ is diffeomorphic to S^4 .

Actually, as proven in Theorem 1.7, the core sphere of e is any nontrivial ribbon 2-knot of 1-fusion. Furthermore, there exist infinitely many cords for such a ribbon 2-knot such that the results all obtain the standard S^4 .

Theorem 1.8. *Let $S \subset S^4$ be any ribbon 2-knot with $\pi_1(E(S)) \not\cong \mathbb{Z}$. Then there exists a nontrivial cord C in $E(S)$ satisfying the following conditions:*

- (1) *The embedding $e : P \hookrightarrow S^4$ has the core sphere S and the cord C .*
- (2) *If for a gluing map g , $S^4(e, g)$ is a homology 4-sphere then it is diffeomorphic to the double of a homology 4-ball H without 3-handles.*

For a general ribbon 2-knot, it is uncertain whether the homology 4-ball H is contractible or not. In Theorem 1.8 we show that for any nontrivial ribbon 2-knot there exists a nontrivial cord such that any pochette surgery yielding a homology 4-sphere gives the double of a homology 4-ball without 3-handles.

Furthermore, when $S^4(e, g)$ is a homotopy 4-sphere, for $S^4(e, g)$ to be the standard S^4 , we have only to assume the AC-triviality of the presentation of π_1 . As a result, we obtain the following theorem.

Theorem 1.9. *If the homology 4-ball H obtained in Theorem 1.8 is contractible and the presentation of $\pi_1(H)$ for a handle decomposition of H without 3-handles is AC-trivial, then $S^4(e, g)$ is standard S^4 .*

In Lemma 4.5, we actually give infinitely many presentations for $\pi_1(H)$ satisfying this condition. This means that such a type of ribbon 2-knots has a nontrivial cord satisfying $S^4(e, g) = S^4$.

It is unknown whether a pochette surgery with nontrivial S_e gives an exotic manifold or not. In general, even if S_e is trivial in a 4-manifold M , then it is unclear whether the pochette surgery is trivial or not. We expect that some pochette surgery creates a new exotic 4-manifold.

1F. Aims of this paper. The first aim of this paper is to investigate pochette surgeries $M(e, g)$ yielding homotopy 4-spheres and to determine the diffeomorphism types. What occurs in the case of nontrivial core sphere? The second aim is what even in this case, we clarify the existence of nontrivial cords that pochette surgeries give the standard S^4 .

1G. Organization of this paper. In Section 2, we give a review for pochette surgery. We define several definitions and lemmas. To carry out the second aim above, we compute the homology of $M(e, g)$ for any homology 4-sphere M . In order to compute the homology, we need to introduce the notion of a linking number for an embedding of a pochette as well as the slope which was defined by Iwase and Matsumoto [7]. The linking number of an embedded pochette is the usual linking number of the embedded core sphere S_e and the longitude l_e in M . It depends on the choice of a meridian m , a longitude l and an embedding $e : P \hookrightarrow M$. Actually, we show that the homology of a pochette surgery is uniquely determined by the slope and the linking number (Proposition 2.5).

In Section 3, first, we prove Theorem 1.4 and clarify that pochette surgeries $M(e, g)$ of the case where the cord is trivial is diffeomorphic to M or some Gluck surgery. Second, we prove Theorem 1.5, by using this result, and we give a sufficient condition that any pochette surgery of M for some core sphere gives the same manifold M or the Gluck surgery. As a particular condition, any $(1/q, \epsilon)$ -pochette surgery of 4-sphere whose core sphere is the unknot is diffeomorphic to S^4 .

In Section 4, we investigate cases where the core sphere S_e is a nontrivial 2-knot and the cord is a nontrivial (Theorem 1.6). These surgeries give the standard 4-sphere. Actually, we use a ribbon 2-knot of 1-fusion as S_e . The proof is essentially proven

in Theorem 1.7. We generalize this situation to some cases where the core spheres are any general nontrivial ribbon 2-knots S with $\pi_1(E(S)) \not\cong \mathbb{Z}$ (Theorem 1.8). However, we did not see whether the resulting manifold is a homotopy 4-sphere or not. In Theorem 1.9, we give a sufficient condition of ribbon 2-knots for the existence of a nontrivial cord such that any surgery yielding homotopy 4-sphere gives the standard S^4 .

2. Preliminaries

2A. Embedding of P . To consider an embedding of P in a 4-manifold M , as mentioned in the previous section, we embed a 2-sphere S in M with product neighborhood and embed a cord in the exterior $E(S)$. In 4-dimension, the isotopy class of any 1-manifold coincides with the homotopy class. Thus, the isotopy class of any embedding of P is determined by a 2-knot with product neighborhood and the homotopy class of a cord as a proper embedding in $E(S)$.

Let S be a 2-knot in a homology 4-sphere M . Here we clarify the isotopy classes of embedding e of P with $S_e = S$. We put $G(S) = \pi_1(E(S))$. $G(S)$ includes a subgroup $\langle m \rangle$ that is isomorphic to \mathbb{Z} . In this section, m is regarded as the class represented by the meridian circle. Here we call $\langle m \rangle$ a *boundary-subgroup*.

In fact, the abelianization map induces the surjection $G(S) \rightarrow H_1(E(S)) \cong \mathbb{Z}$ and the meridian is mapped to a generator in $\mathbb{Z} \subset H_1(E(S))$. Thus m is nontorsion in $G(S)$. We define the set of isotopy classes of cords in $E(S)$ to be

$$\Pi_1(E(S), \partial E(S)) := [(I, \partial I), (E(S), \partial E(S))],$$

and the double coset space $G(S)//\langle m \rangle := \langle m \rangle \backslash G(S) / \langle m \rangle$. Let

$$\varphi : \pi_1(E(S), \partial E(S)) \rightarrow \Pi_1(E(S), \partial E(S))$$

be the natural map.

Lemma 2.1. *Let S be a 2-knot in a homology 4-sphere M . The set of properly embedded cords up to isotopy with the end points included in $\partial E(S)$ has a bijection to the double coset space $G(S)//\langle m \rangle$.*

Proof. By the short exact sequence

$$1 \rightarrow \pi_1(\partial E(S)) \rightarrow \pi_1(E(S)) = G(S) \rightarrow \pi_1(E(S), \partial E(S)) \rightarrow 1$$

induced from the homotopy long exact sequence of the pair $(E(S), \partial E(S))$, we have the bijection

$$\pi_1(E(S), \partial E(S)) \cong \langle m \rangle \backslash G(S).$$

Here $\pi_1(E(S), \partial E(S))$ is the relative homotopy set.

Any element in $\Pi_1(E(S), \partial E(S))$ can be realized as one in $\pi_1(E(S), \partial E(S))$ by homotoping a starting point of the path to the base point x_0 of $\pi_1(E(S), \partial E(S))$. If $\varphi(\gamma_0) = \varphi(\gamma_1)$ for some $\gamma_0, \gamma_1 \in \pi_1(E(S), \partial E(S))$, then

$$\gamma_0(0) = \gamma_1(0) = x_0, \gamma_0(1), \gamma_1(1) \in \partial E(S).$$

There is a homotopy $H : I \times I \rightarrow E(S)$ such that $H(i, \cdot) = \gamma_i$ and $H(t, i) \in \partial E(S)$ ($i = 0, 1$). Then $c(t) := H(t, 0)$ is a loop in $\partial E(S)$ with a base point x_0 , we have $\gamma_0 = \gamma_1 \cdot c \in \pi_1(E(S), \partial E(S))$. Therefore, φ is surjective. If

$$\gamma_0 = \gamma_1 \cdot c \in \pi_1(E(S), \partial E(S))$$

for some $c \in \pi_1(\partial E(S))$, then $\gamma_0 = \gamma_1$ in $\Pi_1(E(S), \partial E(S))$. Thus

$$\pi_1(E(S), \partial E(S)) / \langle m \rangle \rightarrow \Pi_1(E(S), \partial E(S))$$

is bijective.

Then we obtain the bijection

$$\Pi_1(E(S), \partial E(S)) \rightarrow \pi_1(E(S), \partial E(S)) / \langle m \rangle \rightarrow G(S) // \langle m \rangle. \quad \square$$

Let $[[id]]$ be the element in $G(S) // \langle m \rangle$ represented by the trivial cord. Here the class in the double coset is represented by $[[\cdot]]$ and id stands for the identity element in $G(S)$. Hence, if the boundary-subgroup $\langle m \rangle$ is a proper subgroup in $G(S)$, then $G(S) // \langle m \rangle \neq \{ [[id]] \}$. If S is the trivial 2-knot in the 4-sphere, then $G(S) = \langle m \rangle$ and it has a unique isotopy class of a cord. If $G(S)$ is not isomorphic to \mathbb{Z} , then there exists a nontrivial cord.

2B. Fundamental group of pochette surgery. In general, to find a homotopy 4-sphere obtained by applying pochette surgery, we need to compute the fundamental group. Let M be a 4-manifold and e an embedding $e : P \hookrightarrow M$. According to [7], we see that a free isotopy class of an unoriented curve with slope p/q is uniquely determined as an image of m . We call the class a *natural lift*. Let $c_{p,q}$ be the natural lift of $p[m_e] + q[l_e]$ to $\pi_1(\partial E(P_e))$, which is defined in [7]. Let l' , and m' be the images on $\pi_1(\partial E(P_e))$ of the based, oriented, longitude and meridian in ∂P via e respectively. Let $c'_{p,q}$ be an element in $\pi_1(\partial E(P_e))$ presenting $c_{p,q}$. Concretely, the element is given by

$$c'_{p,q} = l'^{\lfloor q/p \rfloor} m'^{\lfloor 2q/p \rfloor - \lfloor q/p \rfloor} m'^{\lfloor 3q/p \rfloor - \lfloor 2q/p \rfloor} \dots m'^{\lfloor pq/p \rfloor - \lfloor ((p-1)q)/p \rfloor} m'.$$

See Theorem 6 in [7].

We assume that the group presentation of $\pi_1(E(S))$ is $\pi_1(E(S)) = \langle S \mid \mathcal{R} \rangle$, where S is a set of generators and \mathcal{R} is a set of relators. For the inclusion maps $i : \partial P_e \rightarrow E(P_e)$ and $j : \partial P \rightarrow P$, the following maps are induced:

$$i_{\#} : \pi_1(\partial P_e) \rightarrow \pi_1(E(P_e)), \quad j_{\#} : \pi_1(\partial P) \rightarrow \pi_1(P).$$

From the Seifert–Van Kampen theorem, we have

$$(1) \quad \pi_1(M(e, p/q, \epsilon)) = \langle S \mid \mathcal{R}, c'_{p,q} \rangle.$$

2C. Mod 2 framing. For a gluing map $g : \partial P \rightarrow \partial E(P_e)$ we define mod 2 framing of $g(m)$ as explained in [7, first paragraph in p. 162]. Let us consider a pochette surgery on M . After attaching $D^2 \times S^2$ in P along $g(m)$, we can uniquely attach the remaining $S^1 \times D^3$. Hence, we have only to consider an identification between neighborhoods of m and $g(m)$ via g to attach P .

We fix an identification

$$\partial P = S^1 \times \partial D^3 \# \partial D^2 \times S^2 = S^1 \times S^2 \# S^1 \times S^2.$$

The meridian $m = \partial D^2 \times \{\text{pt}\} \subset \partial P$ has the natural product framing. We obtain an identification $\iota : \partial E(P_e) \rightarrow S^1 \times S^2 \# S^1 \times S^2$ through the embedding e . Then, $S^1 \times S^2 \# S^1 \times S^2$ can be presented by the 2-component unlink with 0-framings. We map the natural framing on $m \subset \partial P$ to a framing on $g(m)$. The framing is presented by an integer by the identification ι . As far as we consider the diffeomorphism type of the result of the pochette surgery, we have only to consider an integer modulo 2 as the framing on $g(m)$. In fact, consider P as $S^1 \times D^3$ attaching a 2-handle with the cocore m . For two gluing maps $g_1, g_2 : \partial P \rightarrow \partial E(P_e)$ with $g_1(m) = g_2(m)$ but with framings whose difference is divisible by 2, the map $g_1^{-1} \circ g_2|_{N(m)}$ can be extended to the inside of the 2-handle. Namely, two 4-manifolds attached by such gluing maps are diffeomorphic each other. Such a framing on $g(m)$ is called a *mod 2 framing* and written by ϵ .

2D. Linking number. Let l and S be the longitude and the core sphere of a pochette P respectively. Let M be an oriented homology 4-sphere and $e : P \hookrightarrow M$ an embedding. The images l_e , and S_e in M give submanifolds of M . Then they can give the linking number

$$\ell = L(S_e, l_e)$$

according to [3]. In fact, we extend an embedding $e|_S : S \rightarrow M$ to a map $\mathcal{B}^3 \rightarrow M$, where \mathcal{B}^3 is a homology 3-ball. The orientation of \mathcal{B}^3 is induced by the one of S_e . We count the intersection points between the image of \mathcal{B}^3 and l_e with sign. Here we deform l_e in $E(S_e)$ so that l_e can meet with \mathcal{B}^3 transversely. For each intersection point if the concatenation of orientations on \mathcal{B}^3 and l_e at the point coincides with the orientation of M , then the sign is $+1$, otherwise -1 . We call the sign a *local intersection number* at the intersection point. In the end, we sum up the local intersection numbers through all the intersection points. In the same way, we can compute $L(l_e, S_e)$ by changing the order of l_e and S_e .

In the general theory of linking number, the absolute values of $L(S_e, l_e)$ and $L(l_e, S_e)$ are the same. Actually, by the careful consideration of orientation we can

easily obtain $L(S_e, l_e) = -L(l_e, S_e) =: \ell$. We call this number ℓ *linking number* of the embedding e . We must notice that the linking number is *not* an invariant of the embedding of P . If we fix the coordinate m and l , then the linking number can be determined. This is due to what the 3-disk separating $S^1 \times D^3$ and $D^2 \times S^2$ is not unique.

Here let us reinterpret the linking number $L(S_e, l_e)$ in terms of the homology. We use the intersection pairing:

$$\langle \cdot, \cdot \rangle_3^4 : H_3(E(S_e), \partial(E(S_e))) \times H_1(E(S_e)) \rightarrow \mathbb{Z}.$$

Let \mathcal{M}^3 be a Seifert hypersurface of S_e in $E(S_e)$, namely \mathcal{M}^3 is a properly embedded 3-manifold in $E(S_e)$ satisfying $\partial\mathcal{M}^3 = S_e$. $H_3(E(S_e), \partial(E(S_e)))$ is isomorphic to $\mathbb{Z}[\mathcal{M}^3]$. Here $\mathcal{M}^3 \cap E(S_e)$ and \mathcal{M}^3 are identified. $H_3(E(P_e), \partial E(P_e))$ is isomorphic to $\mathbb{Z}[\mathcal{M}^3]$.

The intersection point between \mathcal{M}^3 and m_e is one point. Here we give an orientation on \mathcal{M}^3 satisfying $\langle [\mathcal{M}^3], [m_e] \rangle_3^4 = +1$.

By the definition of linking number, it follows that $\langle [\mathcal{M}^3], [l_e] \rangle_3^4 = \ell$. Since $H_1(E(S_e))$ is also isomorphic to \mathbb{Z} generated by $[m_e]$, we have $[l_e] = \ell[m_e]$.

In the similar way we consider the next intersection pairing:

$$\langle \cdot, \cdot \rangle_2^4 : H_2(E(l_e), \partial(E(l_e))) \times H_2(E(l_e)) \rightarrow \mathbb{Z}.$$

Here we take a proper embedded surface Σ satisfying $\partial\Sigma = l_e$ in $E(l_e)$. We take the usual orientation of the meridian B_e of l_e and the orientation on Σ by using $\langle [\Sigma], [B_e] \rangle_2^4 = +1$. From the computation $L(l_e, S_e) = -\ell$ of the linking number, we obtain $\langle [\Sigma], [S_e] \rangle_2^4 = -\ell$. Since $H_2(E(l_e))$ is isomorphic to \mathbb{Z} generated by the belt sphere $[B_e]$, $[S_e] = -\ell[B_e]$ holds.

2E. The homology of a pochette surgery. Let M be a homology 4-sphere. Here we compute the homology of the result by pochette surgery. Let $g : \partial P \rightarrow \partial E(P_e)$ be a gluing map with the slope p/q and the mod 2 framing ϵ . Let i be the inclusion map $\partial E(P_e) \rightarrow E(P_e)$.

To compute the homology group of any pochette surgery of a homology 4-sphere, we prove lemmas needed later. First, we compute the homology of $E(P_e)$ here. Since $E(P_e)$ is connected, we have $H_0(E(P_e)) \cong \mathbb{Z}$.

Lemma 2.2. $E(P_e)$ has the following homology groups:

$$H_n(E(P_e)) = \begin{cases} \mathbb{Z} \cdot [m_e], & n = 1, \\ \mathbb{Z} \cdot [B_e], & n = 2, \\ 0, & n \geq 3. \end{cases}$$

Proof. Let h^3 be a 4-dimensional 3-handle. Attaching h^3 on the belt sphere of P_e , we obtain $E(P_e) \cup h^3 = E(S_e)$ and $E(P_e) \cap h^3 = \partial D^3 \times D^1 = S^2 \times D^1$. The

homology of $E(S_e)$ is the same as the homology of S^1 and the first homology group is generated by the meridian m_e . Since H_1 is independent of attaching any 3-handle, we have $H_1(E(P_e)) = H_1(E(P_e) \cup h^3) = H_1(E(S_e)) = \mathbb{Z}[m_e] \cong \mathbb{Z}$. Then we obtain the Mayer–Vietoris sequence:

$$\cdots \rightarrow H_n(S^2 \times D^1) \rightarrow H_n(E(P_e)) \oplus H_n(h^3) \rightarrow H_n(E(S_e)) \rightarrow \cdots .$$

Thus, we can easily check

$$H_n(E(P_e)) = \begin{cases} \mathbb{Z}, & n = 2, \\ 0, & n = 3, 4. \end{cases}$$

The generator of H_1 clearly corresponds to the meridian m_e of $E(S_e)$ and the one of H_2 corresponds to the generator, the belt sphere B_e which is the image of $H_2(S^2 \times D^1)$. □

From this lemma, we obtain natural isomorphisms $H_1(E(P_e)) \cong H_1(E(S_e))$ and $H_2(E(P_e)) \cong H_2(E(S_e))$. The isomorphisms are induced by the inclusions and connect the corresponding elements $[m_e]$ and $[B_e]$.

Let g be a gluing map from ∂P to $\partial E(P_e)$. Suppose that $g_*([m]) = p[m_e] + q[l_e]$ is satisfied on the first homology group.

Lemma 2.3. *If $g_*([m]) = p[m_e] + q[l_e]$, then we have $g_*([B]) = p[B_e] - q[S_e]$.*

Proof. We put $g_*([l]) = r[m_e] + s[l_e]$, $g_*([B]) = x[B_e] + y[S_e]$. Then, we can define the nondegenerate bilinear form $\langle \cdot, \cdot \rangle_3 : H_1(\partial P) \times H_2(\partial P) \rightarrow \mathbb{Z}$ from the cup product $H^2(\partial P) \times H^1(\partial P) \rightarrow H^3(\partial P)$.

By defining

$$\langle [m], [B] \rangle_3 = 0, \quad \langle [l], [B] \rangle_3 = 1, \quad \langle [m], [S] \rangle_3 = 1 \quad \text{and} \quad \langle [l], [S] \rangle_3 = 0,$$

we determine the orientations on m and B . These orientations coincide with the ones determined Section 2D via the map $H_n(\partial P_e) \rightarrow H_n(E(P_e))$. Since $g : \partial P \rightarrow \partial E(P_e)$ is a diffeomorphism, we can define the nondegenerate bilinear form $\langle \cdot, \cdot \rangle_3^e : H_1(\partial E(P_e)) \times H_2(\partial E(P_e)) \rightarrow \mathbb{Z}$ from the nondegenerate bilinear form $\langle \cdot, \cdot \rangle_3 : H_1(\partial P) \times H_2(\partial P) \rightarrow \mathbb{Z}$. Since $g : \partial P \rightarrow \partial E(P_e)$ is an orientation preserving diffeomorphism, the determinant of the matrix given by

$$(g_*([m]) \ g_*([l])) = ([m_e] \ [l_e]) \begin{pmatrix} p & r \\ q & s \end{pmatrix}$$

is 1. Hence we obtain $ps - qr = 1$. Thus the inverse is as

$$(g_*^{-1}([m_e]) \ g_*^{-1}([l_e])) = ([m] \ [l]) \begin{pmatrix} s & -r \\ -q & p \end{pmatrix}.$$

Since

$$\langle g_*(\alpha), g_*(\beta) \rangle_3^e = \langle \alpha, \beta \rangle_3 \quad \text{for all } \alpha \in H_1(\partial P), \beta \in H_2(\partial P),$$

we have

$$\begin{aligned} x &= \langle [l_e], x[B_e] + y[S_e] \rangle_3^e = \langle [l_e], g_*([B]) \rangle_3^e = \langle g_*^{-1}([l_e]), [B] \rangle_3 \\ &= \langle -r[m] + p[l], [B] \rangle_3 = p \end{aligned}$$

and

$$\begin{aligned} y &= \langle [m_e], x[B_e] + y[S_e] \rangle_3^e = \langle [m_e], g_*([B]) \rangle_3^e = \langle g_*^{-1}([m_e]), [B] \rangle_3 \\ &= \langle s[m] - q[l], [B] \rangle_3 = -q. \end{aligned}$$

Therefore, we obtain the desired result above. □

Lemma 2.4. *Let e be an embedding $P \hookrightarrow M$ with linking number ℓ . Let i be an inclusion $i : \partial E(P_e) \rightarrow E(P_e)$. Then $i_*([l_e]) = \ell[m_e]$ and $i_*([S_e]) = -\ell[B_e]$ are satisfied.*

Proof. The image of $[l_e] \in H_1(\partial E(P_e))$ by i_* is also $[l_e]$ in $H_1(E(P_e))$. Since $H_1(E(P_e))$ and $H_1(E(S_e))$ are identified with each other by the natural isomorphism by the inclusion, the elements $[m_e]$ having in these homology groups are mapped. Hence, from Section 2D, $[l_e] = \ell[m_e]$ also holds in $H_1(E(P_e))$. In the same way, we have $i_*([S_e]) = -\ell[B_e]$. □

Here, we compute the homology groups of the pochette surgery $M(e, p/q, \epsilon)$. Since M is connected and oriented, $H_0(M(e, p/q, \epsilon)) \cong H_4(M(e, p/q, \epsilon)) \cong \mathbb{Z}$ is satisfied. We compute H_n of M for $n = 1, 2, 3$.

Proposition 2.5. *Let M be a homology 4-sphere. Let e be an embedding with linking number ℓ . Then, $M(e, p/q, \epsilon)$ has the following homology groups:*

(i) *If $p + q\ell \neq 0$, then*

$$H_n(M(e, p/q, \epsilon)) \cong \begin{cases} \mathbb{Z}/(p + q\ell)\mathbb{Z}, & n = 1, 2, \\ 0, & n = 3. \end{cases}$$

(ii) *If $p + q\ell = 0$, then*

$$H_n(M(e, p/q, \epsilon)) \cong \begin{cases} \mathbb{Z}, & n = 1, 3, \\ \mathbb{Z}^2, & n = 2. \end{cases}$$

Note that the case of $p + q\ell = 0$ means $(p, q) = (\ell, -1), (-\ell, 1)$ because p, q are relatively prime.

Proof. The embedding map $e : P \hookrightarrow M$ induces the map

$$H_n(\partial P) \xrightarrow{g_*} H_n(\partial E(P_e)) \xrightarrow{i_*} H_n(E(P_e)).$$

Then we have $H_1(\partial E(P_e)) = \mathbb{Z} \cdot [m_e] \oplus \mathbb{Z} \cdot [l_e]$, $H_2(\partial E(P_e)) = \mathbb{Z} \cdot [B_e] \oplus \mathbb{Z} \cdot [S_e]$ and obtain $g_*([m]) = p[m_e] + q[l_e]$, $i_*([m_e]) = [m_e]$ and $i_*([B_e]) = [B_e]$. By Lemma 2.3,

we obtain $g_*([B]) = p[B_e] - q[S_e]$. By Lemma 2.4, we have $i_*([L_e]) = \ell[m_e]$ and $i_*([S_e]) = -\ell[B_e]$. By Lemma 2.2 and the Mayer–Vietoris sequence

$$\cdots \rightarrow H_*(E(P_e)) \oplus H_*(P) \rightarrow H_*(M(e, p/q, \epsilon)) \rightarrow H_{*-1}(\partial P) \rightarrow \cdots,$$

we obtain

$$\begin{array}{ccccccc} \longrightarrow & 0 & \longrightarrow & H_3(M(e, p/q, \epsilon)) & \xrightarrow{\partial_3} & \mathbb{Z} \cdot [B] \oplus \mathbb{Z} \cdot [S] \\ \xrightarrow{j_{21} \oplus j_{22}} & \mathbb{Z} \cdot [B_e] \oplus \mathbb{Z} \cdot [S] & \xrightarrow{i_2} & H_2(M(e, p/q, \epsilon)) & \xrightarrow{\partial_2} & \mathbb{Z} \cdot [m] \oplus \mathbb{Z} \cdot [l] \\ \xrightarrow{j_{11} \oplus j_{12}} & \mathbb{Z} \cdot [m_e] \oplus \mathbb{Z} \cdot [l] & \xrightarrow{i_1} & H_1(M(e, p/q, \epsilon)) & \xrightarrow{\partial_1 = 0} & H_0(\partial P) \end{array}$$

We put $j_n = j_{n1} \oplus j_{n2}$ for any $n \in \mathbb{Z}$. Since we have $\partial_1 = 0$, i_1 is a surjection. Since we have $j_1([m]) = (p + q\ell)[m_e]$ and $j_1([l]) = (r + s\ell)[m_e] + [l]$, we obtain

$$\begin{aligned} H_1(M(e, p/q, \epsilon)) &= \text{Im } i_1 \cong \mathbb{Z} \cdot [m_e] \oplus \mathbb{Z} \cdot [l] / \langle (p + q\ell)[m_e], (r + s\ell)[m_e] + [l] \rangle \\ &\cong \mathbb{Z} \cdot [m_e] / \langle (p + q\ell)[m_e] \rangle \cong \mathbb{Z} / (p + q\ell)\mathbb{Z}. \end{aligned}$$

Here r, s are the same coefficients as the ones used in the proof of Lemma 2.3.

Next, we compute H_2 and H_3 of the result of the pochette surgery.

If $p + q\ell \neq 0$, then j_1 is an injection. Since i_2 is a surjection, we obtain the following isomorphism:

$$\begin{aligned} H_2(M(e, p/q, \epsilon)) &= \text{Im } i_2 \\ &\cong \mathbb{Z} \cdot [B_e] \oplus \mathbb{Z} \cdot [S] / \langle (p + q\ell)[B_e], (r' + s'\ell)[B_e] + [S] \rangle \\ &\cong \mathbb{Z} \cdot [B_e] / \langle (p + q\ell)[B_e] \rangle \cong \mathbb{Z} / (p + q\ell)\mathbb{Z}. \end{aligned}$$

Here, r', s' are some integers satisfying $ps' + qr' = 1$. In this case, $\text{Im } \partial_3 = \text{Ker } j_2 = 0$. Thus we have

$$H_3(M(e, p/q, \epsilon)) = \text{Ker } \partial_3 = 0.$$

If $p + q\ell = 0$, then $\text{Im } \partial_2 = \text{Ker } j_1 = \mathbb{Z} \cdot [m]$. Thus we have

$$H_2(M(e, p/q, \epsilon)) \cong \text{Im } i_2 \oplus \mathbb{Z} \cdot [m] \cong \mathbb{Z} \cdot [B_e] \oplus \mathbb{Z} \cdot [m].$$

In this case, $\text{Im } \partial_3 = \text{Ker } j_2 = \mathbb{Z} \cdot [B]$. Thus we have

$$H_3(M(e, p/q, \epsilon)) \cong \mathbb{Z} \cdot [B].$$

Therefore, we obtain the desired result above. □

The theorems by Whitehead [15], Freedman [4] and Proposition 2.5 imply the next corollary.

Corollary 2.6. *Let M be a homology 4-sphere. $M(e, p/q, \epsilon)$ is homeomorphic to S^4 if and only if $M(e, p/q, \epsilon)$ is a simply connected 4-manifold and $|p + q\ell|$ is equal to 1.*

Proof. By Freedman’s theorem, $M(e, p/q, \epsilon)$ is homeomorphic to S^4 if and only if $M(e, p/q, \epsilon)$ is homotopy equivalent to S^4 . We will only show that $M(e, p/q, \epsilon)$ is homotopy equivalent to S^4 if and only if $M(e, p/q, \epsilon)$ is a simply connected 4-manifold and $|p + q\ell| = 1$. By the Whitehead theorem, the necessary and sufficient condition for a manifold to be homotopy equivalent to S^4 is $\pi_1 = \{\text{id}\}$ and $H_n = 0$ for $n = 1, 2, 3$. From Proposition 2.5, we can easily check this corollary follows. \square

2F. Images of the meridian by diffeomorphism. In this section we describe images of m via some gluing maps $g : \partial P \rightarrow \partial E(P_e)$ with slope $1/p$ and $p/(p + 1)$. In the first diagram in Figure 1 we describe $m, l \subset \#^2 S^2 \times S^1$. By sliding along the dashed arrow in the first picture, m is moved to a curve represented by $[m] + [l]$ in the second picture. Furthermore, sliding the diagram along the dashed arrow, we obtain the third picture. Then $[m] + [l]$ is moved to a curve by represented by $[m] + 2[l]$. By the same diffeomorphism, $[m] + 2[l]$ is moved to a curve represented by $[m] + 3[l]$ in the fourth picture.

Thus, by the diffeomorphism $h : \#^2 S^2 \times S^1 \rightarrow \#^2 S^2 \times S^1$ with slope $1/p$, meridian m is moved to a curve represented in $[m] + p[l]$ as in the bottom picture in Figure 1. This position will be used when we describe the handle diagram of $M(e, 1/p, \epsilon)$.

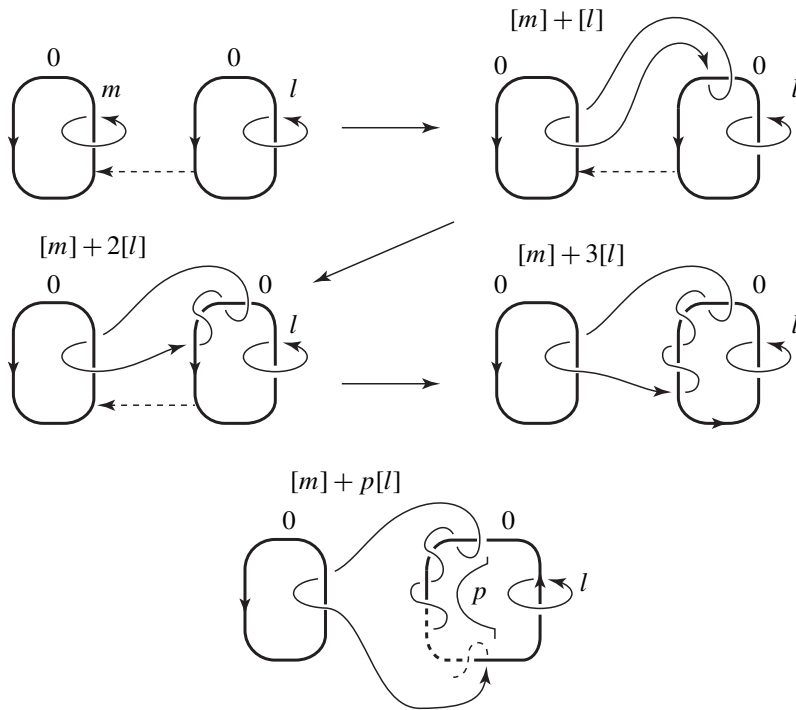

Figure 1. Images of m and l via a gluing map $\#^2 S^2 \times S^1 \rightarrow \#^2 S^2 \times S^1$.

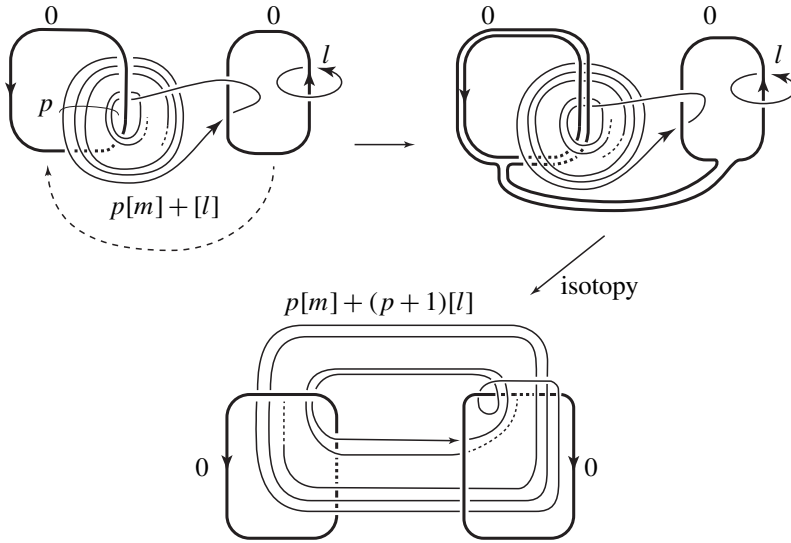

Figure 2. Case (I).

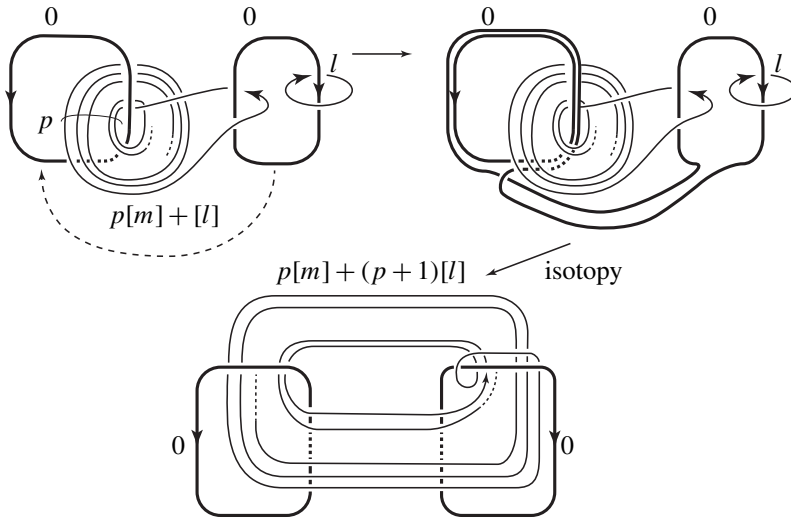

Figure 3. Case (II).

Furthermore, exchanging m and l in the last picture in Figure 1 and doing an isotopy, we obtain a curve represented by $p[m] + [l]$ as in the first pictures in Figures 2 and 3. We call these cases Case (I) and Case (II) respectively. Sliding a 0-framed 2-handle, we obtain the second picture. The thin curves in the figures are represented by $p[m] + (p + 1)[l]$. By an isotopy we obtain the last pictures in Figures 2 and 3.

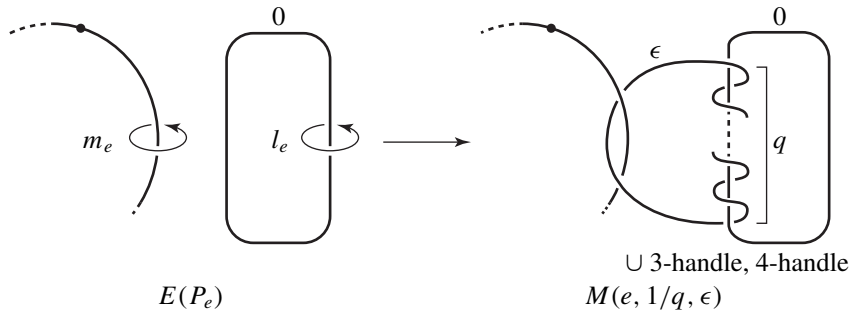

Figure 4. Attaching P on $E(P_e)$ with the trivial cord.

3. Proofs of Main theorems

In this section we prove Theorem 1.4.

Proof of Theorem 1.4. Let e be an embedding $P \hookrightarrow M$ with a trivial cord. The exterior $E(P_e)$ is obtained by attaching a 0-framed 2-handle on $E(S_e)$ in a separated position from the diagram of $E(S_e)$ as in the left picture of Figure 4. The circle m_e in the figure is the image of meridian of P . For example, when we describe $E(S_e)$ along the motion picture as in [5, Section 6.2], it is a meridian of a 1-handle corresponding to a 0-handle of the embedded sphere. Hence, the pochette surgery on M can be obtained by attaching an ϵ -framed 2-handle on $E(P_e)$ plus a 3-handle and a 4-handle. The position of the ϵ -framed 2-handle is understood from the argument in Section 2F. The right picture in Figure 4 is the local picture of the handle diagram of $M(e, 1/q, \epsilon)$.

Here, we prove that the rightmost 0-framed knot in Figure 4 is isotopic to the unknot in $\partial(E(S_e) \cup h^2(\epsilon)) = S^3$, where $h^2(\epsilon)$ is the ϵ -framed 2-handle. We remove the previous 3- and 4-handle in $M(e, 1/q, \epsilon)$. Since the boundary of obtained manifold is diffeomorphic to the ϵ -Dehn surgery of $\partial E(S_e)$. By several handle moves, we obtain the Hopf link surgery that the framing coefficients of the two components are $\langle 0 \rangle$ and $\langle \epsilon \rangle$. Then we get the second picture in Figure 5. From this point, doing slides by q -times, we obtain the fifth picture. Canceling the Hopf link component, we obtain 0-framed knot as in the last picture in Figure 5. Hence, this 0-framed unknot is isotopic to the unknot.

Since we can move the 0-framed unknot in the last picture in Figure 4 to the unlink position in the same picture, we cancel this component with a 3-handle. The remaining diagram is obtained by attaching an ϵ -framed 2-handle and a 4-handle on $E(S_e)$. Therefore, the resulting manifold is the trivial surgery or the Gluck surgery along S_e depending on $\epsilon = 0$ or 1 respectively. \square

Using this theorem, we can prove Theorem 1.5.

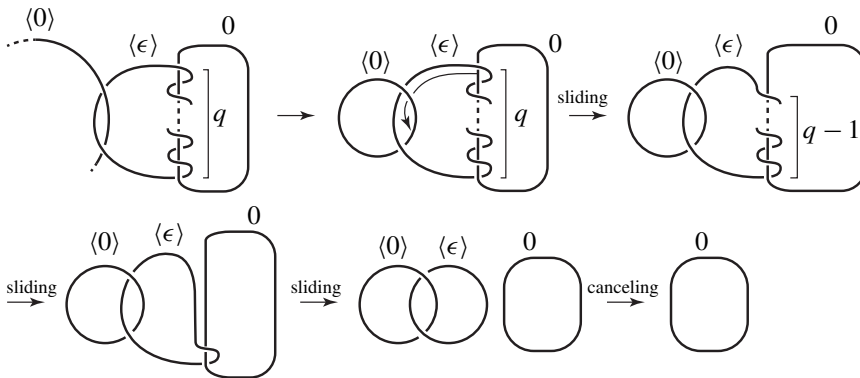

Figure 5. The isotopy type of the rightmost component.

Proof of Theorem 1.5. Let e be an embedding $P \hookrightarrow M$. If $G(S_e) \cong \mathbb{Z}$ holds, then $\pi_1(E(S_e), \partial E(S))$ consists of one element. This means that any cord in $E(S_e)$ is isotopic to the trivial cord. Moving the embedded 1-handle in P around the meridian $\partial D^2 \times \{\text{pt}\}$ as an isotopy of e , we can make the linking number zero. Hence, if the pochette surgery produces a homology 4-sphere, then the slope is $1/q$ for some meridian and longitude in P . From Theorem 1.4, the result is M (when $\epsilon = 0$) or $Gl(S_e)$ (when $\epsilon = 1$).

If M is diffeomorphic to S^4 and S_e is the unknot, then any cord is isotopic to the trivial one. In the same way as above, any pochette surgery yielding a homology 4-sphere gives S^4 . □

4. Examples

4A. Pochette surgeries along ribbon 2-knots of 1-fusion. In this section, we consider diffeomorphism types of pochette surgeries on the 4-sphere with nontrivial core spheres and nontrivial cords.

Now we define *ribbon 2-knot* and *fusion*.

Definition 4.1 (ribbon 2-knot). Let $\{D_1^3, \dots, D_m^3\}$ be m pairwise disjoint 3-disks in S^4 . We take $m - 1$ pairwise disjoint embeddings $f_1, \dots, f_{m-1} : D^2 \times [0, 1] \rightarrow S^4$. We assume that the embeddings satisfy the following conditions:

- $f_k(D^2 \times [0, 1]) \cap \bigcup_{u=1}^m \partial D_u^3 = f_k(D^2 \times \{0, 1\})$ for any $1 \leq k \leq m - 1$.
- $\bigcup_{k=1}^{m-1} f_k(D^2 \times [0, 1]) \cup \bigcup_{u=1}^m \partial D_u^3$ is connected.

Then the boundary of union of these m 3-disks and $m - 1$ $D^2 \times [0, 1]$

$$\bigcup_{u=1}^m \partial D_u^3 \cup \bigcup_{k=1}^{m-1} f_k(\partial D^2 \times [0, 1])$$

is a 2-knot and called a *ribbon 2-knot* of $(m - 1)$ -fusion.

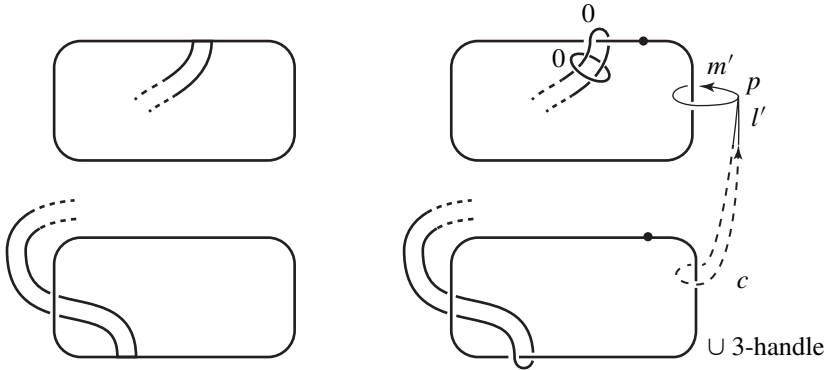

Figure 6. A ribbon 2-knot of 1-fusion (left) and the diagram of the complement of the 2-knot (right).

We take any ribbon 2-knot of 1-fusion as core spheres. Let S denote a ribbon 2-knot of 1-fusion in the 4-sphere. The sphere S is the double of a disk obtained by attaching one band over two 2-disks as presented by the left picture in Figure 6. The right diagram is the handle diagram of the complement of S . Let $m' \subset \partial E(S_e)$ be the oriented meridian of a dotted 1-handle indicated in Figure 6 with a base point p . Let l' be an oriented meridian of the other dotted 1-handle passing p . Pushing the complement (the dashed line in the right picture in Figure 6) of the neighborhood of l' in the interior of $E(S_e)$, we obtain a cord c . Then the following holds.

Lemma 4.2. *If $G(S_e)$ is not isomorphic to \mathbb{Z} , then this cord c is nontrivial.*

Recall the triviality of a cord was defined in Definition 1.2.

Proof. The fundamental group $G(S_e)$ is presented by

$$\langle x, y \mid wxw^{-1}y^{\pm 1} \rangle,$$

where x and y are the elements presented by the meridian m' and the longitude l' respectively, and w is a word obtained by reading x, y along the 2-handle corresponding to the band. Here the boundary-subgroup in $G(S_e)$ is $\langle x \rangle$.

Let $p : G(S_e) \rightarrow G(S_e) // \langle x \rangle$ be the projection for the double coset. Let $[\text{id}]$ be the trivial coset in $G(S_e) // \langle x \rangle$, which is the coset including the identity element $\text{id} \in G(S_e)$. The inverse image $p^{-1}([\text{id}])$ is equal to $\langle x \rangle$. In fact $\langle x \rangle \subset p^{-1}([\text{id}])$ is clear. For any $z \in p^{-1}([\text{id}])$, there exist some integers r, s such that $x^r z x^s = \text{id}$ is satisfied. Then $z = x^{-r-s} \in \langle x \rangle$.

The homotopy class of the cord c corresponds to $[[y]] \in G(S_e) // \mathbb{Z}$. If the cord c is trivial, then $y \in p^{-1}([\text{id}]) = \langle x \rangle$ holds. Hence we have $y = x^n$ for some integer n . This means $G(S_e)$ is an abelian group. Since the abelianization of $G(S_e)$ is \mathbb{Z} , we have $G(S_e) \cong \mathbb{Z}$. □

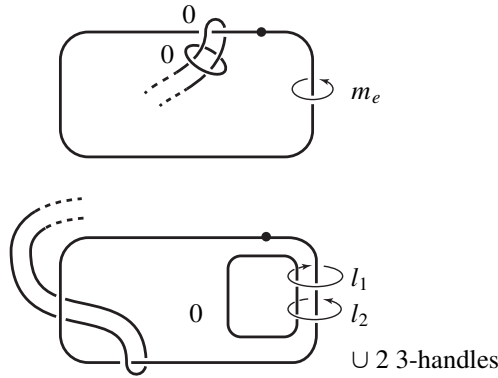

Figure 7. The pochette complement whose core sphere is a ribbon 2-knot of 1-fusion.

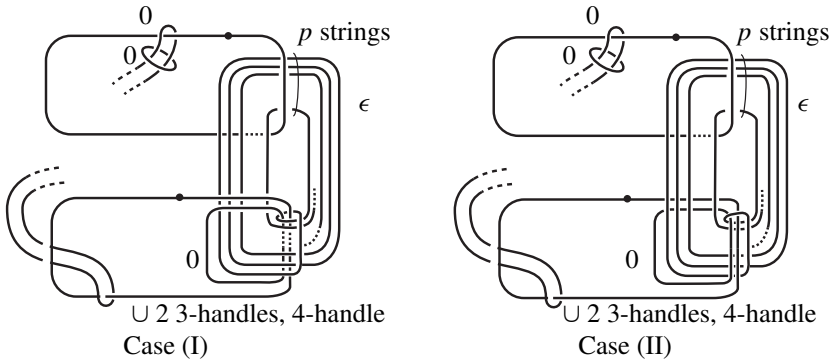

Figure 8. (I): m_e is isotopic to l_1 . (II): m_e is isotopic to l_2 .

In general, it is well-known that $G(S_e) \cong \mathbb{Z}$ is satisfied for many nontrivial 2-knot S_e . Then the cord c is nontrivial.

By using this cord c , we obtain an embedding $e : P \hookrightarrow S^4$ whose core sphere is S . Then the handle diagram of the complement $E(P_e)$ of P is Figure 7. The meridian m_e is isotopic to l_1 or l_2 in $E(S_e)$. Here we assume that m_e is isotopic to l_i . Then, we put the orientation of the longitude as $[l_e] = -[l_i]$ in $E(P_e)$. Then $[m_e] = -[l_e]$ in $H_1(E(S_e))$ is satisfied. In this situation, the linking number of P_e is -1 . Consider the $(p/(p + 1), \epsilon)$ -pochette surgery by using the embedding e and these oriented meridian and longitude in P . The element $y \in \pi_1(E(P_e))$ is a lift of $-[l_1]$ and y^{-1} is a lift of $-[l_2]$, and hence $y^{\pm 1}$ is a lift of the longitude l_e .

According to the last pictures in Figures 2 and 3, the cases (I) and (II) in Figure 8 are obtained as results of attaching P along $p[m_e] + (p + 1)[l_e]$ with the mod 2 framing ϵ . The case (I) is the one which m_e is isotopic to l_1 (as an oriented loop), while (II) is the case where m_e is isotopic to l_2 in the same way.

To prove Theorem 1.7, we first prove the following:

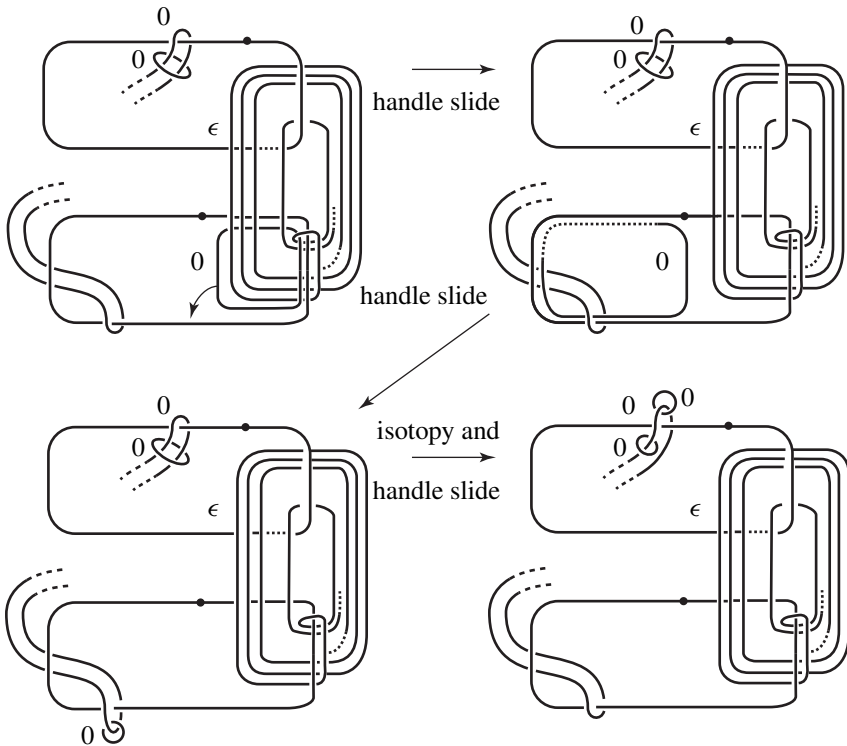

Figure 9. Handle moves.

Proposition 4.3. $S^4(e, p/(p+1), \epsilon)$ is diffeomorphic to the double of a contractible 4-manifold without no 3-handles.

Proof. Here we will consider the case where m_e is isotopic to l_2 . The case where m_e is isotopic to l_1 can be proved in the same way.

We deform the handle diagram of (II) as in Figure 9. Continuously, we deform the handle diagram according to Figure 10. We show that the last picture presents that $S^4(e, p/(p+1), \epsilon)$ is diffeomorphic to the double of a contractible 4-manifold C . The fundamental group $\pi_1(C)$ of C has the following presentation

$$(2) \quad \langle x, y \mid wxw^{-1}y^{\pm 1}, y^{\pm 1}(xy^{\pm 1})^p \rangle,$$

according to the last picture in Figure 10. The proof of the triviality of this group is postponed in Lemma 4.4. The homology group of C is easily found out to be trivial from the handle decomposition. \square

As mentioned in [2, second paragraph in p. 36], the following result holds. Let C be a contractible 4-manifold with n 1-handles, n 2-handles and no 3-handles. If the presentation $\pi_1(C)$ with respect to the handle decomposition is AC-trivial, which is defined in the next section, then the double satisfies $D(C) := C \cup_{\text{id}} (-C) = \partial(C \times I)$.

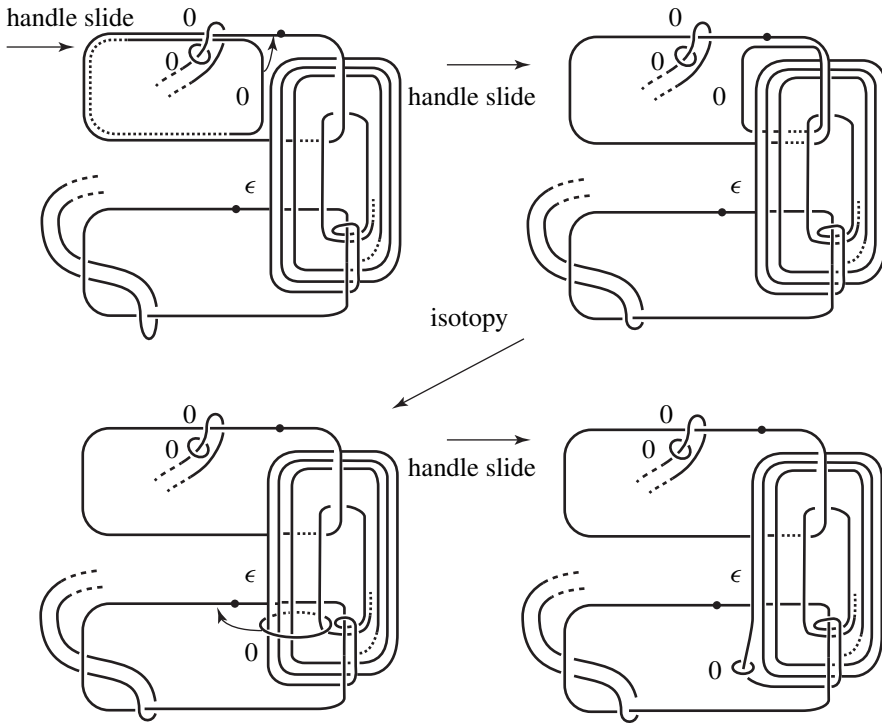

Figure 10. Handle moves.

Since the handle decomposition of $\mathcal{C} \times I$ depends only on the homotopy classes of the 2-handles, $\mathcal{C} \times I$ is diffeomorphic to the standard D^5 . In the next section, we give a brief review of Andrews–Curtis moves and Andrews–Curtis trivial.

4B. AC-triviality. Let $F = F(X)$ be a free group of rank $n \geq 2$ with a basis $X = \{x_1, \dots, x_n\}$ and $W = (w_1, \dots, w_n)$ an n -tuple of words of X . Consider the following three types of transformations of W :

- (AC1): Replace w_i by $w_i w_j$ if $j \neq i$.
- (AC2): Replace w_i by w_i^{-1} .
- (AC3): Replace w_i by $v w_i v^{-1}$ for some $v \in F$, and leave w_k fixed for all $k \neq i$.

Let $R = \langle x_1, \dots, x_n \mid w_1, \dots, w_n \rangle$ be a presentation of the trivial group. We call base transformations (inversion and permutation of generators and relators) of X , the transformations (AC1)–(AC3) for relators w_1, \dots, w_n , and adding or deleting a generator g and a relator g as the same element *Andrews–Curtis moves* (or *AC-moves*). If R can be reduced to the empty presentation $\langle \emptyset \mid \emptyset \rangle$ by a finite sequence of AC-moves for the basis and relators, then R is called an *AC-trivial presentation*.

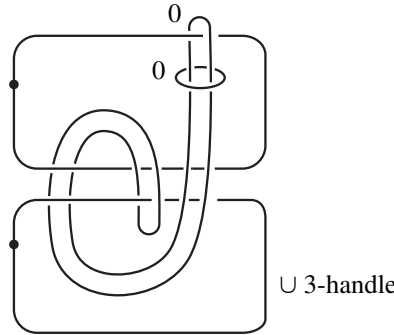

Figure 11. A handle diagram of a ribbon 2-knot exterior.

Lemma 4.4. *The presentation (2) is an AC-trivial presentation of the trivial group.*

Proof. We give the following sequence of AC-moves:

$$\begin{aligned}
 \langle x, y \mid wxw^{-1}y^{\pm 1}, y^{\pm 1}(xy^{\pm 1})^p \rangle &= \langle x, xy^{\pm 1} \mid wxw^{-1}x^{-1}(xy^{\pm 1}), x^{-1}(xy^{\pm 1})^{p+1} \rangle \\
 &= \langle x, z \mid wxw^{-1}x^{-1}z, x^{-1}z^{p+1} \rangle \\
 &= \langle x^{-1}z^{p+1}, z \mid wxw^{-1}x^{-1}z, x^{-1}z^{p+1} \rangle \\
 &= \langle u, z \mid w(z^{p+1}u^{-1})w^{-1}uz^{-p}, u \rangle = \langle z \mid z^m \rangle.
 \end{aligned}$$

Here since this group is trivial, $m = \pm 1$. Thus the presentation is AC-trivial. \square

We left the proof of the triviality of $\pi_1(C)$ in Proposition 4.3. Lemma 4.4 implies the proof of Proposition 4.3 completes.

Proof of Theorem 1.7. Let $e : S^2 \hookrightarrow S^4$ be a ribbon 2-knot of 1-fusion. We take the same cord c as the one chosen in Section 4A, which is used in Figure 6. By using Proposition 4.3, the pochette surgery $S^4(e, p/(p + 1), \epsilon)$ is diffeomorphic to the double of a contractible 4-manifold C . The C has an AC-trivial presentation of π_1 coming from a handle decomposition of C with no 3-handles. By applying the method in [2], $S^4(e, p/(p + 1), \epsilon) = D(C)$ is diffeomorphic to the standard 4-sphere. \square

Proof of Theorem 1.6. Let S and c be the ribbon 2-knot and the cord that we dealt with in Theorem 1.7. Then S is nontrivial and c is nontrivial. The pochette surgery gives the standard S^4 . \square

4C. A case of spun trefoil knot. As an example, we give a concrete diagram for the spun trefoil knot as a ribbon 2-knot of 1-fusion. Figure 11 is the handle diagram of the complement.

We choose m_e and l_e as in Figure 12 (left), then the embedding $i : \partial P_e \hookrightarrow E(P_e)$ gives $i_*([l_e]) = -[m_e]$. Namely the linking number is $\ell = -1$. Let x, y be lifts

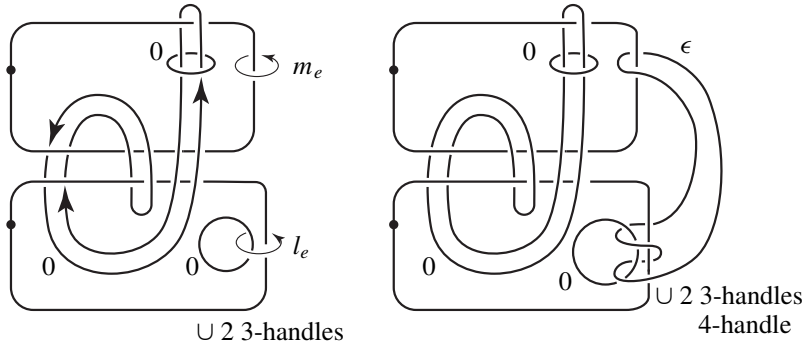

Figure 12. A pochette surgery $S^4(e, \frac{1}{2}, \epsilon)$ with a nontrivial 2-knot S_e and a nontrivial cord.

in $\pi_1(S^4(e, \frac{1}{2}, \epsilon))$ of generators m_e and l_e respectively. Then the presentation of $\pi_1(S^4(e, \frac{1}{2}, \epsilon))$ is the following:

$$\langle x, y \mid yx^{-1}yx^{-1}x, y^2x \rangle \cong \{\text{id}\}.$$

The diagram of this homotopy 4-sphere becomes the right picture in Figure 12. In this case, we can deform this diagram into the double of a contractible 4-manifold with no 3-handles as in Figure 13.

4D. Pochette surgeries along ribbon 2-knots of n -fusion. The method to prove Theorem 1.7 can be easily extended to the case of the surgery that the core sphere is any ribbon 2-knot of n -fusion.

Proof of Theorem 1.8. Let S be any ribbon 2-knot of n -fusion. We fix the handle decomposition of $E(S)$ corresponding to the fusion. That is, the decomposition has one 0-handle, $n + 1$ dotted 1-handles, n 2-handles and n dual 2-handles and $n + 1$ 3-handles and one 4-handle. See [5, Section 6.2] for the description of ribbon 2-knot complement. We take two based meridians m' and l' of the dotted 1-handles with a base point $p_0 \in \partial E(S)$. We suppose that m' lies in $\partial E(S)$ and is a meridian of $\partial E(S)$. Let x, y be elements in $\pi_1(E(S))$ corresponding to m' and l' respectively. Here we can assume that $y^{\pm 1}$ is conjugate to x but $y^{\pm 1} \notin \langle x \rangle$. Actually, if any based meridian of each dotted 1-handle of $E(S)$ is in an element in $\langle x \rangle$, then $\pi_1(E(S))$ is a quotient of \mathbb{Z} , because the set of the meridians of the dotted 1-handles is a generator of $\pi_1(E(S))$. Actually using the abelianization map $\pi_1(E(S)) \xrightarrow{ab} H_1(E(S)) = \mathbb{Z}$, we conclude that $\pi_1(E(S))$ is isomorphic to \mathbb{Z} . Now this case is ruled out. Thus, there exists a based meridian $l' \subset E(S)$ such that $y := [l']$ is conjugate to x but $y \notin \langle x \rangle$.

In the same way as the proof of Theorem 1.7, from l' we produce a cord in $E(S)$. Thus, by taking such a cord, we obtain a pochette embedding $e : P \hookrightarrow S^4$. By moving the 0-framed 2-handle by the process in Figures 9 and 10, we can take the 0-framed 2-handle in the position of the meridian of the ϵ -framed 2-handle.

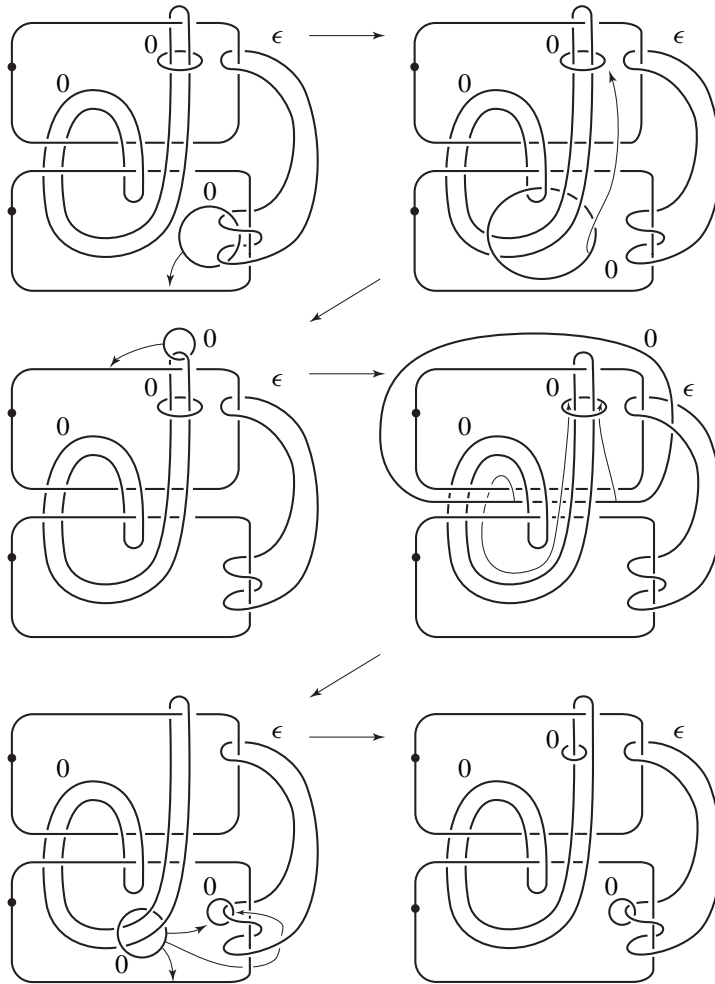

Figure 13. A diffeomorphism to the double of a contractible 4-manifold.

If the graph for the n -fusion is as in Figure 14. This is just a schematic picture for the fusion, and the edges stand for connecting 0-framed 2-handles coming from the bands of the ribbon disk. Actually, in the true picture, the edges should be drawn as some bands and might be linking to several dotted 1-handles. For our proof, we may omit these data because sliding the 0-framed 2-handle to dual 2-handles, we can ignore the linking.

We take the two based oriented meridians m' and l' in the positions in the figure. We suppose that the below 0-framed 2-handle in the first picture in Figure 9 is attached in the dashed circle in Figure 14 in our situation. From the 1-handle k linking to l' to the 1-handle k' linking to m' , the 0-framed 2-handle can be moved by doing several handle slides and some isotopy. See Figure 15 for the handle

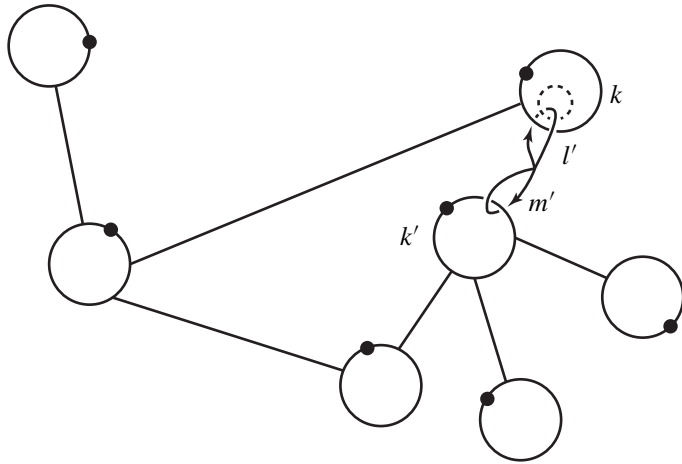

Figure 14. A graph for the fusion of a ribbon 2-knot.

moves. This also generalizes the moves from the first picture in Figure 9 to the second picture in Figure 10. Hence, we can freely move the 0-framed 2-handle from a dotted 1-handle to another dotted 1-handle.

By these handle slides, all 0-framed 2-handles corresponding to the dual bands can be moved in the meridians of all 2-handles. This means that $S^4(e, p/(p+1), \epsilon)$ is the double of a homology 4-ball H without 3-handles. \square

As mentioned in Section 1 as well, it is unclear whether any homology 4-sphere obtained by this pochette surgery is simply connected or not.

If the 2-knot is n -fusion ribbon knot, the fundamental group of $S^4(e, p/(p+1), \epsilon)$ has the form

$$(3) \quad \langle x_1, \dots, x_{n+1} \mid w_1 x_{i_1} w_1^{-1} x_{j_1}^{-1}, \dots, w_n x_{i_n} w_n^{-1} x_{j_n}^{-1}, x_s^{-1} (x_r x_s^{-1})^p \rangle,$$

where for $k = 1, 2, \dots, n$, w_k is a word in x_1, \dots, x_{n+1} , the set

$$\{\{i_k, j_k\} \mid k = 1, \dots, n\}$$

is the set of edges of the graph, and r, s are some integers in $\{1, \dots, n\}$. Even if H in the proof of Theorem 1.8 is contractible, that is, the fundamental group is trivial then it is unclear whether $S^4(e, p/(p+1), \epsilon)$ is diffeomorphic to S^4 or not.

Proof of Theorem 1.9. If the homology 4-ball H in the proof above is contractible, then $S^4(e, g) = H \cup (-H)$ is a homotopy 4-sphere. Furthermore, if the presentation of π_1 coming from the handle decomposition is AC-trivial, then from the method mentioned right after the proof of Theorem 1.7, therefore, $S^4(e, g)$ is diffeomorphic to the standard S^4 . \square

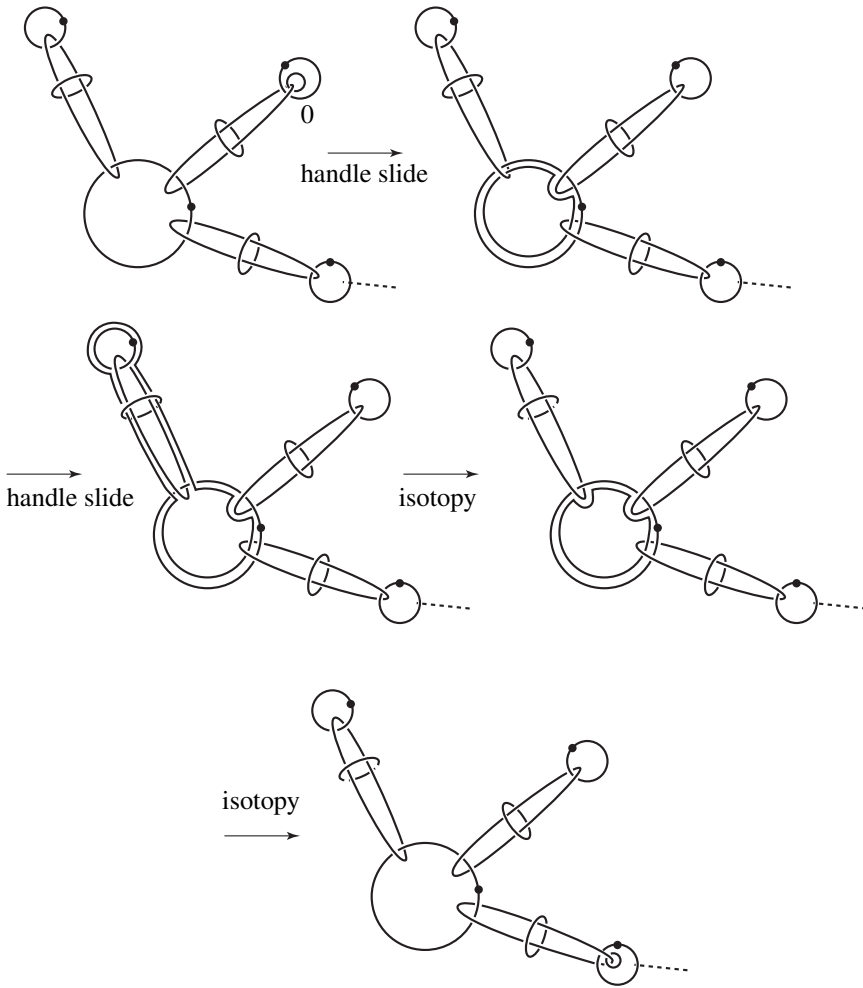

Figure 15. Deformations to move the 0-framed meridian in the position.

We give a sufficient condition that the presentation (3) is AC-trivial. Let $\{x_1, \dots, x_{n+1}\}$ be a generator of the free group F_{n+1} . For any word w of x_1, \dots, x_{n+1} , we put $r_{2i-1} = wx_{2i}w^{-1}x_{2i+1}^{-1}$ for $2i - 1 < n$, $r_{2i} = wx_{2i+2}w^{-1}x_{2i+1}^{-1}$ for $2i < n$ and

$$r_n = \begin{cases} wx_{n+1}w^{-1}x_1^{-1}, & n \text{ is odd,} \\ wx_1w^{-1}x_{n+1}^{-1}, & n \text{ is even.} \end{cases}$$

Then we consider the presentation

$$\langle x_1, \dots, x_{n+1} \mid r_1, \dots, r_n \rangle.$$

This presentation gives the fundamental group of the complement of a ribbon 2-knot of n -fusion.

Lemma 4.5. *Let n be a positive integer. For any word w of x_1, \dots, x_{n+1} , the relators r_1, \dots, r_n are the same as above. For $r_{n+1} = x_1^{-1}(x_2x_1^{-1})^p$, the presentation*

$$(4) \quad \langle x_1, \dots, x_{n+1} \mid r_1, \dots, r_n, r_{n+1} \rangle$$

is the trivial group presentation with AC-trivial.

Proof. We obtain

$$r_{2i-1} r_{2i}^{-1} = wx_{2i} x_{2i+2}^{-1} w^{-1} \sim x_{2i} x_{2i+2}^{-1} \quad \text{and} \quad r_{2i+1}^{-1} r_{2i} = x_{2i+3}^{-1} x_{2i+2},$$

$r_{n-1}^{-1} r_n = x_n x_1^{-1}$ if n is odd, $r_{n-1} r_n^{-1} = wx_n x_1^{-1} w^{-1} \sim x_n x_1^{-1}$ if n is even, where \sim presents the relation between conjugate elements. Then we have

$$\begin{aligned} &\langle x_1, \dots, x_{n+1} \mid r_1, r_2, r_3, \dots, r_n, r_{n+1} \rangle \\ &\cong \langle x_1, \dots, x_{n+1} \mid r_1 r_2^{-1}, r_2, r_3, \dots, r_n, r_{n+1} \rangle \\ &\cong \langle x_1, \dots, x_{n+1} \mid r_1 r_2^{-1}, r_2^{-1} r_3, r_3, \dots, r_n, r_{n+1} \rangle \\ &\cong \langle x_1, \dots, x_{n+1} \mid r_1 r_2^{-1}, r_2^{-1} r_3, r_3 r_4^{-1}, \dots, r_n, r_{n+1} \rangle \\ &\cong \begin{cases} \langle x_1, \dots, x_{n+1} \mid r_1 r_2^{-1}, r_2^{-1} r_3, r_3 r_4^{-1}, \dots, r_{n-1}^{-1} r_n, r_n, r_{n+1} \rangle, & n \text{ is odd,} \\ \langle x_1, \dots, x_{n+1} \mid r_1 r_2^{-1}, r_2^{-1} r_3, r_3 r_4^{-1}, \dots, r_{n-1} r_n^{-1}, r_n, r_{n+1} \rangle, & n \text{ is even} \end{cases} \\ &\cong \langle x_1, \dots, x_{n+1} \mid x_2 x_4^{-1}, x_3 x_5^{-1}, x_4 x_6^{-1}, \dots, x_{n-1} x_{n+1}^{-1}, x_n x_1^{-1}, r_n, r_{n+1} \rangle. \end{aligned}$$

Replacing $x_i x_{i+2}^{-1}$ with x'_i for $i = 2, \dots, n - 1$ and $x_n x_1^{-1}$ with x'_n , we give

$$\begin{aligned} x_2 &= \begin{cases} x'_2 x'_4 x'_6 \cdots x'_{n-1} x_{n+1}, & n \text{ is odd,} \\ x'_2 x'_4 x'_6 \cdots x'_n x_1, & n \text{ is even,} \end{cases} \\ r_n &= \begin{cases} w' x_{n+1} (w')^{-1} x_1^{-1}, & n \text{ is odd,} \\ w' x_1 (w')^{-1} x_{n+1}^{-1}, & n \text{ is even,} \end{cases} \end{aligned}$$

where w' is a word of x_1, x'_i and x_{n+1} and we have

$$\begin{aligned} &\langle x_1, \dots, x_{n+1} \mid r_1, r_2, r_3, r_4, \dots, r_n, r_{n+1} \rangle \\ &\cong \langle x_1, x'_2, \dots, x'_n, x_{n+1} \mid x'_2, x'_3, x'_4, \dots, x'_{n-1}, x'_n, r_n, r_{n+1} \rangle \\ &\cong \begin{cases} \langle x_1, x_{n+1} \mid w' x_{n+1} (w')^{-1} x_1^{-1}, x_1^{-1} (x_{n+1} x_1^{-1})^p \rangle, & n \text{ is odd,} \\ \langle x_1, x_{n+1} \mid w' x_1 (w')^{-1} x_{n+1}^{-1}, x_1^{-1} \rangle, & n \text{ is even.} \end{cases} \end{aligned}$$

By applying Lemma 4.4, we see that this presentation is AC-trivial. Therefore, we obtain the desired result above. □

5. Questions

In this section we raise several questions. We leave the following problem about Theorem 1.8.

Question 5.1. *Let S be any ribbon 2-knot with $G(S) \not\cong \mathbb{Z}$. Does there exist a nontrivial cord c in $E(S)$ such that any nontrivial surgery with respect to the embedding $e : P \hookrightarrow S^4$ with the cord c and the core sphere S yielding a homology 4-sphere gives the standard 4-sphere?*

Since pochette surgery is a generalization of Gluck surgery, the triviality of Gluck surgery on any ribbon 2-knot might also hold in the pochette surgery situation.

Question 5.2. *Let S be any ribbon 2-knot with $G(S) \not\cong \mathbb{Z}$. Suppose that $e : P \hookrightarrow S^4$ is any embedding with $S_e = S$. Does any pochette surgery $S^4(e, g)$ yielding a homology 4-sphere for some gluing map g give the 4-sphere?*

It might be possible that we answer the following question affirmatively.

Question 5.3. *Let S be any ribbon 2-knot in S^4 with $G(S) \not\cong \mathbb{Z}$. If a pochette surgery with the core sphere S yields a homology 4-sphere, is the pochette surgery the standard 4-sphere?*

Can the diffeomorphisms in the previous section be generalized to cases of any nontrivial core sphere?

Question 5.4. *Let S be any 2-knot with $G(S) \not\cong \mathbb{Z}$. Then, does there exist a nontrivial cord in $E(S)$ such that any pochette surgery for a pochette embedding $e : P \hookrightarrow S^4$ with the core sphere S is S^4 or $Gl(S)$?*

Can we construct a homotopy 4-sphere other than $Gl(S)$ by pochette surgery? Furthermore, we raise two questions in more generalized settings.

Question 5.5. *Can a pochette surgery of S^4 construct an exotic S^4 ?*

More generally, we ask the following question.

Question 5.6. *Can a pochette surgery of an oriented 4-manifold M construct an exotic structure on M ?*

Pochette surgery can be generalized to a surgery on a *generalized pochette* $P_{a,b} = \natural^a S^1 \times D^3 \natural^b D^2 \times S^2$. Such a surgery is called an *outer surgery* and it is studied by Nakamura in [10]. Would studying outer surgery lead to the construction of interesting 4-manifolds? Investigating outer surgery is a potential avenue for future research about exotic 4-manifolds.

Acknowledgements

Hisaaki Endo, an adviser of Suzuki, has constantly encouraged and advised our work and we thank him. The authors appreciate a referee for giving us helpful comments and suggestions.

References

- [1] S. Akbulut, “Constructing a fake 4-manifold by Gluck construction to a standard 4-manifold”, *Topology* **27**:2 (1988), 239–243. MR Zbl
- [2] S. Akbulut, “Cork twisting Schoenflies problem”, *J. Gökova Geom. Topol. GGT* **8** (2014), 35–43. MR Zbl
- [3] G. E. Bredon, *Topology and geometry*, Graduate Texts in Mathematics **139**, Springer, New York, 1997. MR Zbl
- [4] M. H. Freedman, “The topology of four-dimensional manifolds”, *J. Differential Geometry* **17**:3 (1982), 357–453. MR Zbl
- [5] R. E. Gompf and A. I. Stipsicz, *4-manifolds and Kirby calculus*, Graduate Studies in Mathematics **20**, American Mathematical Society, Providence, RI, 1999. MR Zbl
- [6] C. M. Gordon, “Knots in the 4-sphere”, *Comment. Math. Helv.* **51**:4 (1976), 585–596. MR Zbl
- [7] Z. Iwase and Y. Matsumoto, “4-dimensional surgery on a “pochette””, pp. 161–166 in *Proceedings of the East Asian School of knots, links and related topics*, 2004.
- [8] P. M. Melvin, *Blowing up and down in 4-manifolds*, Ph.D. thesis, University of California, Berkeley, 1977, available at <https://www.proquest.com/docview/302865311>. MR
- [9] Y. Murase, *Pochette surgery and Kirby diagrams*, master’s thesis, Tokyo Institute of Technology, 2015. In Japanese.
- [10] S. Nakamura, *On a generalization of Iwase–Matsumoto’s pochette surgery and its applications*, master’s thesis, The University of Tokyo, 2018. In Japanese.
- [11] P. Naylor and H. R. Schwartz, “Gluck twisting roll spun knots”, *Algebr. Geom. Topol.* **22**:2 (2022), 973–990. MR Zbl
- [12] T. Okawa, *On pochette surgery on the 4-sphere*, master’s thesis, Tokyo Institute of Technology, 2020. In Japanese.
- [13] P. S. Pao, “The topological structure of 4-manifolds with effective torus actions, I”, *Trans. Amer. Math. Soc.* **227** (1977), 279–317. MR Zbl
- [14] T. Suzuki, “Constructions of homotopy 4-spheres by pochette surgery”, preprint, 2022. arXiv 2205.05239
- [15] J. H. C. Whitehead, “On simply connected, 4-dimensional polyhedra”, *Comment. Math. Helv.* **22** (1949), 48–92. MR Zbl

Received September 11, 2022. Revised March 27, 2023.

TATSUMASA SUZUKI
DEPARTMENT OF MATHEMATICS
TOKYO INSTITUTE OF TECHNOLOGY
TOKYO
JAPAN
suzuki.t.do@m.titech.ac.jp

MOTOO TANGE
INSTITUTE OF MATHEMATICS
UNIVERSITY OF TSUKUBA
IBARAKI
JAPAN
tange@math.tsukuba.ac.jp

PACIFIC JOURNAL OF MATHEMATICS

Founded in 1951 by E. F. Beckenbach (1906–1982) and F. Wolf (1904–1989)

msp.org/pjm

EDITORS

Don Blasius (Managing Editor)
Department of Mathematics
University of California
Los Angeles, CA 90095-1555
blasius@math.ucla.edu

Matthias Aschenbrenner
Fakultät für Mathematik
Universität Wien
Vienna, Austria
matthias.aschenbrenner@univie.ac.at

Paul Balmer
Department of Mathematics
University of California
Los Angeles, CA 90095-1555
balmer@math.ucla.edu

Vyjayanthi Chari
Department of Mathematics
University of California
Riverside, CA 92521-0135
chari@math.ucr.edu

Robert Lipshitz
Department of Mathematics
University of Oregon
Eugene, OR 97403
lipshitz@uoregon.edu

Kefeng Liu
Department of Mathematics
University of California
Los Angeles, CA 90095-1555
liu@math.ucla.edu

Sorin Popa
Department of Mathematics
University of California
Los Angeles, CA 90095-1555
popa@math.ucla.edu

Paul Yang
Department of Mathematics
Princeton University
Princeton NJ 08544-1000
yang@math.princeton.edu

PRODUCTION

Silvio Levy, Scientific Editor, production@msp.org

See inside back cover or msp.org/pjm for submission instructions.

The subscription price for 2023 is US \$605/year for the electronic version, and \$820/year for print and electronic. Subscriptions, requests for back issues and changes of subscriber address should be sent to Pacific Journal of Mathematics, P.O. Box 4163, Berkeley, CA 94704-0163, U.S.A. The Pacific Journal of Mathematics is indexed by Mathematical Reviews, Zentralblatt MATH, PASCAL CNRS Index, Referativnyi Zhurnal, Current Mathematical Publications and Web of Knowledge (Science Citation Index).

The Pacific Journal of Mathematics (ISSN 1945-5844 electronic, 0030-8730 printed) at the University of California, c/o Department of Mathematics, 798 Evans Hall #3840, Berkeley, CA 94720-3840, is published twelve times a year. Periodical rate postage paid at Berkeley, CA 94704, and additional mailing offices. POSTMASTER: send address changes to Pacific Journal of Mathematics, P.O. Box 4163, Berkeley, CA 94704-0163.

PJM peer review and production are managed by EditFLOW® from Mathematical Sciences Publishers.

PUBLISHED BY

 **mathematical sciences publishers**
nonprofit scientific publishing

<http://msp.org/>

© 2023 Mathematical Sciences Publishers

PACIFIC JOURNAL OF MATHEMATICS

Volume 324 No. 2 June 2023

Polynomial conditions and homology of FI-modules CIHAN BAHRAN	207
A lift of West's stack-sorting map to partition diagrams JOHN M. CAMPBELL	227
Limit cycles of linear vector fields on $(\mathbb{S}^2)^m \times \mathbb{R}^n$ CLARA CUFÍ-CABRÉ and JAUME LLIBRE	249
Horospherical coordinates of lattice points in hyperbolic spaces: effective counting and equidistribution TAL HORESH and AMOS NEVO	265
Bounded Ricci curvature and positive scalar curvature under Ricci flow KLAUS KRÖNCKE, TOBIAS MARXEN and BORIS VERTMAN	295
Polynomial Dedekind domains with finite residue fields of prime characteristic GIULIO PERUGINELLI	333
The cohomological Brauer group of weighted projective spaces and stacks MINSEON SHIN	353
Pochette surgery of 4-sphere TATSUMASA SUZUKI and MOTOO TANGE	371