

THE JOURNAL OF THE ANTI-SEISMIC SYSTEMS INTERNATIONAL SOCIETY (ASSISI)

Seismic Isolation and Protection Systems

LEAD-RUBBER HYSTERETIC BEARINGS SUITABLE FOR PROTECTING STRUCTURES DURING EARTHQUAKES

William H. Robinson

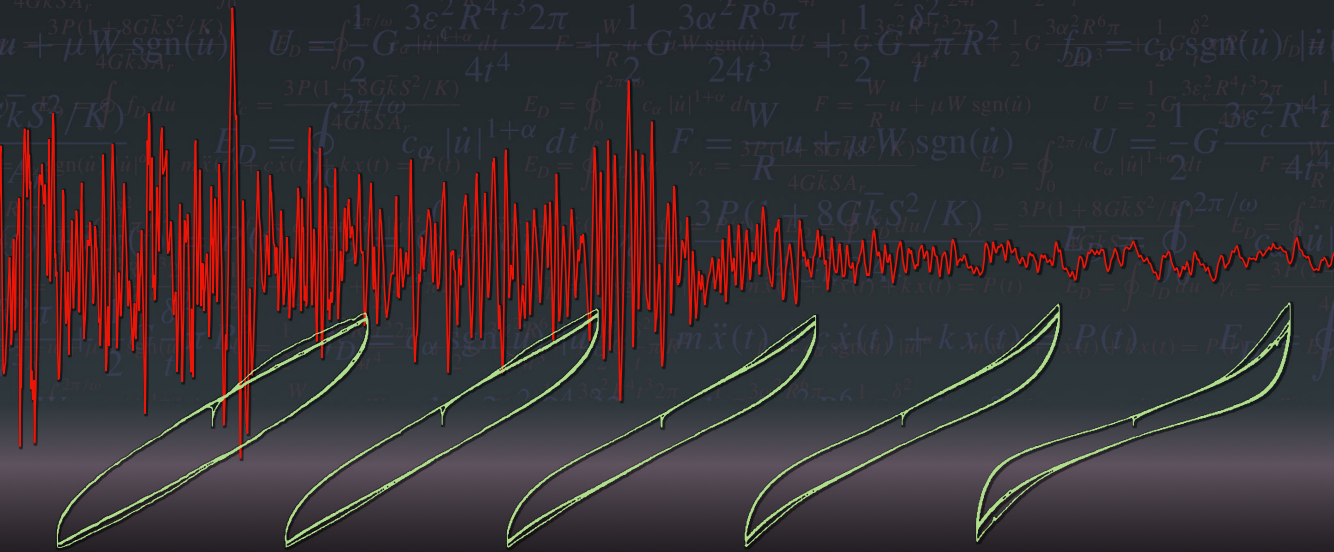

vol 2, no 1

2011

LEAD-RUBBER HYSTERETIC BEARINGS SUITABLE FOR PROTECTING STRUCTURES DURING EARTHQUAKES

WILLIAM H. ROBINSON

Reprinted with permission from *Earthquake Engineering and Structural Dynamics* **10**:4, 593–604 (1982)

Lead-rubber hysteretic bearings provide in a single unit the combined features of vertical load support, horizontal flexibility and energy absorbing capacity required for the base isolation of structures from earthquake attack. The lead-rubber hysteretic bearing is a laminated elastomeric bearing of the type used in bridge structures, with a lead plug down its centre.

Since the invention of the lead-rubber bearing, a total of eleven bearings up to a diameter of 650 mm, with lead plugs ranging from 50 to 170 mm in diameter, have been tested under various conditions, including vertical loads to 3.15 MN, strokes to ± 110 mm, rates from 1 mm/h to 100 mm/s, and temperatures of -35°C to $+45^{\circ}\text{C}$. In all of these tests, the lead-rubber bearings behaved satisfactorily and the hysteresis loops could be described reasonably well by assuming that the lead behaved as an elastic-plastic solid with a yield stress in shear of 10.5 MPa. The bearings showed little rate dependence at ~ 100 mm/s, though at creep rates of ~ 1 mm/h the force due to the lead dropped to 30 per cent of that at typical earthquake frequencies. The effect of many small displacements has been tested with 11 000 cycles at ± 3 mm. A total of 92 lead-rubber bearings have been used in New Zealand to base isolate one building and three bridges. They have yet to be used overseas.

This paper describes the tests on the lead-rubber bearings, the results and a design procedure for selecting the size of the lead plug.

Introduction

Since 1970 a number of papers have been written describing how base-isolated structures can be protected from damage caused by earthquake attack [Skinner et al. 1975a; Skinner and McVerry 1975]. These base-isolated structures normally sit on PTFE sliding bearings or rubber elastomeric bearings. The main effect of the base isolation is to decouple the structure from the ground and increase the resonant period of the structure plus bearings to a value outside the range of periods containing the principal earthquake energies. More complete base isolation studies have shown that further reduction in forces and moments transmitted to the structure occurs if some Coulomb damping, usually ~ 5 per cent of the weight, is placed in parallel with the base isolation [Lee and Medland 1981; Meggett 1978]. Another advantage of the addition of damping is that it may cause a reduction of displacement of the structure by a factor of ~ 2 to a more manageable size of $\sim \pm 100$ mm.

During the seventies a range of hysteretic dampers was invented and developed at the Physics and Engineering Laboratory to provide the required damping for base isolation [Robinson and Greenbank 1975; 1976; Skinner et al. 1975b; 1980]. In New Zealand the plasticity of steel and its good fatigue

Keywords: history, lead-rubber bearings.

properties during cyclic plastic strain have been used in a torsion beam damper installed in the NZ Railways Rangitikei Bridge, in a tapered cantilever damper used in a Dunedin motorway bridge, and more recently in a flexural beam damper designed for Cromwell Bridge. The plastic deformation of lead for hysteretic dampers began with the invention of the lead extrusion damper, a device which behaves as a rigid-plastic solid. Twelve extrusion dampers designed to operate at 150 kN and with a maximum stroke of ± 250 mm have been manufactured by Auckland Nuclear Accessories Ltd and installed by Ministry of Works and Development (MWD) in two overpass bridges in Wellington, New Zealand. The sloping bridge decks are supported vertically by glide bearings and the extrusion dampers connect the decks to the fixed abutments; they have a high stiffness and low creep rate which minimizes any movement of the bridge due to the braking of traffic (~ 1 or 2 mm/yr). [Skinner et al. 1980] is a summary and discussion of the work on hysteretic dampers.

The lead-rubber hysteretic bearing is a more recent innovation [Robinson 1975; Robinson and Tucker 1983; 1977] and consists of an elastomeric bearing with a lead plug down its centre (Figure 1). It is possibly the cheapest solution to the problems of base isolation in that the one unit supports the base-isolated structure, provides an elastic restoring force and also, by the selection of the appropriate size of lead plug, produces the required amount of damping.

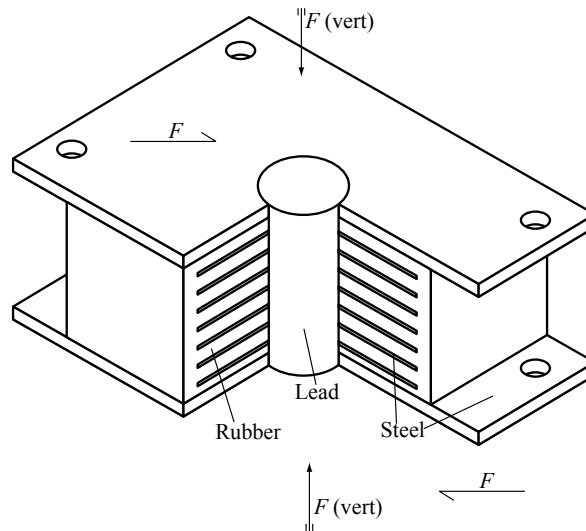

Figure 1. Lead-rubber hysteretic bearing.

In this paper the properties of the lead-rubber hysteretic bearing are described together with its behaviour under various loading conditions: a design procedure is discussed before describing a number of applications which include the building and three bridges which already have been base isolated by lead-rubber bearings.

Description of the lead-rubber hysteretic bearings

Before describing the hysteretic bearing in detail it is worthwhile considering the reasons for choosing lead as the material for the insert in the bearings. First, in shear the lead yields at the relatively low stress of ~ 10 MPa and behaves approximately as an elastic-plastic solid. Thus a reasonable size insert of

~100 mm in diameter is required to produce the necessary plastic damping forces of ~100 kN. Second, at room temperature when lead is plastically deformed it is being ‘hot worked’ and the mechanical properties of the lead are being continuously restored by the interrelated processes of recovery, recrystallization and grain growth which are occurring simultaneously [Birchenell 1959; Wulff et al. 1956]. In fact plastically deforming lead at 20°C is equivalent to plastically deforming iron or steel at a temperature of greater than 450°C. Therefore, lead has good fatigue properties during cycling at plastic strains [Robinson and Greenbank 1976]. Third, because of its use in batteries, lead is readily available at the high purity of 99.9 per cent required for its mechanical properties to be predictable.

The normal elastomeric bearing consists of alternate layers of rubber sheets cemented or vulcanized to steel plates. The cemented elastomeric bearing and the vulcanized version have been used for over two decades in bridge structures. The elastomeric bearing supports the weight of the structure, provides an elastic restoring force and in the case of bridges allows the bridge to expand thermally without causing excessive forces in the bridge structure.

The elastomeric bearing is readily converted into a lead-rubber hysteretic bearing by placing a lead plug down its centre (Figure 1). The hole for the lead plug can be machined through the bearing after manufacture or, if numbers permit, the hole can be made in the steel plates and rubber sheets before they are joined together. The lead is then cast directly into the hole or machined into a plug before being pressed into the hole. For both methods of placing the lead it is imperative that the lead plug is a tight fit in the hole and that it locks with the steel plates and extrudes a little into the layers of rubber. To ensure this occurs it is recommended that the lead plug volume be 1 per cent greater than the hole volume enabling the lead plug to be firmly pressed into the hole. Thus, when the elastomeric bearing is deformed horizontally, the lead insert is forced by the interlocking steel plates to deform over its whole volume in pure shear.

Altogether six different elastomeric bearings were tested with lead inserts (see Table 1). The first, to see if the concept would work, was a small cemented bearing and it was tried with lead plugs of two diameters. The second was a large vulcanized bearing which was progressively fitted with lead inserts of five different diameters, to determine the effect of the diameter of the lead insert on the hysteresis

Dimensions (mm)	d (mm)	k_r (kN/mm)	k_v (kN/mm)	h/d	$x(\max)$ (mm)	$\gamma(\max)$	$F(\text{vert})$ (MN)	Comments
356 × 356 × 140	56, 100	0.5		2.5, 1.4	±68	0.49	0.45	Cemented
650 diam × 197	50, 70, 100, 140, 170	1.75	600	4 to 1.15	±91	0.46	1, 2, 3	Vulcanized
600 × 600 × 207	105	1.70	600	2.0	±110	0.53	1, 2, 3	Vulcanized Two bearings for Wm Clayton Building
280 × 230 × 127	75	0.55	205	1.7	±93	0.73	0.16 to 0.21	Vulcanized One bearing for Toe Toe Bridge
406 × 356 × 177	75	0.50	190	2.4	±83	0.47	0.35	Vulcanized One bearing for Waiotukupuna Bridge

Table 1. Summary of lead-rubber bearings tested.

loop and to demonstrate the feasibility of using lead inserts in large elastomeric bearings. The next two lead-rubber bearings were selected from 82 manufactured for the Wm Clayton Building, Wellington, and the final two, one each from the Toe Toe and Waitotukupuna Bridges.

Properties of the lead-rubber hysteretic bearings

(i) *Test equipment.* To determine the force-displacement hysteresis loops of the various bearings at speeds of 1 mm/h to 100 mm/s three combinations of equipment were used. The first lead-rubber bearing tested was mounted back to back with a bearing not containing a lead plug and the plate between the bearing was moved while a vertical load of up to 450 kN was applied to both bearings via a hydraulic jack (Figure 2). For high speed tests this movement was produced via a linkage to a cam on a modified Caterpillar D8. The creep behaviour was determined by mounting the bearing holder in a 250 kN Instron testing machine capable of operating at 10^{-3} mm/min to 200 mm/min.

After the first bearing had been tested a more rigid bearing holder capable of high vertical forces (3.15 MN) was constructed for the dynamic tests based on the requirements of the bearings for the Wm Clayton Building. The lead-rubber bearings were mounted horizontally, one at a time, in this rig. Underneath the rubber bearing was a horizontally located pressure plate which transmitted the vertical force from four hydraulic jacks to the bearing. On top of the bearing was a moving plate attached via a linkage to the drive of the Caterpillar D8. The upper face of the moving plate was greased and rubbed against fifty-two $20 \times 20 \times 2$ mm squares of PTFE bonded to a steel reaction plate. In the design the



Figure 2. Lead-rubber bearing in 250 kN Instron.

friction force on the lubricated PTFE was estimated to be 1 per cent of the normal reaction with a design vertical pressure up to 30 MPa [Tyler 1977]. The rig was designed for a maximum power of 100 kW, maximum vertical force of 4 MN, maximum horizontal force of 500 kN, a maximum stroke of 250 mm (± 125 mm) and maximum frequency of 0.9 Hz, though in fact for these tests at high loads the maximum power was approximately 70 kW.

(ii) **Hysteresis loops.** In order to derive the force-displacement hysteresis loops from the experimental results it was necessary to subtract the shear force due to the sliding PTFE. This shear force was determined by testing dynamically the 650 mm diameter elastomeric bearing before it was fitted with a lead plug. For this rubber bearing there occurred on reversal of stroke a sudden change in force which was dependent on the vertical load. The sudden change in force on reversal of the direction of shear velocity was taken to be twice the shear force due to the PTFE and was found to be in good agreement with previous work [Tyler 1977].

The force-displacement hysteresis loop of an elastomeric bearing without a lead plug is shown as the dotted curve in Figure 3. This loop, which is for the bearing 650 mm in diameter, is mainly elastic with a shear stiffness, $k_r = 1.75$ kN/mm, and a small amount of hysteresis. Also in the figure is the result for the same bearing containing a lead insert with a diameter of 170 mm. The dashed lines are at the slope of 1.75 kN/mm and are a good approximation to the post yield stiffness, k_{ab} , between the points 'a' and 'b' where 'a' and 'b' are at zero and the maximum displacement respectively. In this case the lead is behaving as a plastic solid which adds ~ 235 kN to the elastic force required to shear the bearing. However, this is one of the better results in that for all of the dynamic tests the post yields stiffness varied between $k_r \pm 40$ per cent with most results between $k_r \pm 25$ per cent. For example, for the Waiotukupuna bearing the post yield stiffness was $k_{ab} = 1.25k_r$ (Figure 4), while for the Wm Clayton bearing $k_{ab} = 0.8k_r$ (Figure 5).

Another factor of interest is the initial elastic part of the force-displacement curve for small forces. This shear stiffness is found to lie between 9 and $15k_r$, with most of the results near $10k_r$. It must be

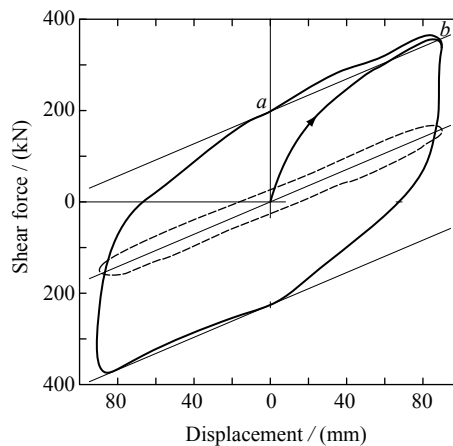

Figure 3. Force-displacement hysteresis loops for 650 mm diameter bearing ($F(\text{vert}) = 3.15$ MN, 0.9 Hz, stroke ± 91 mm). Dotted line is for the bearing without a lead plug while the full line is for a lead plug of 170 mm diameter. Slope of dashed lines is k_r .

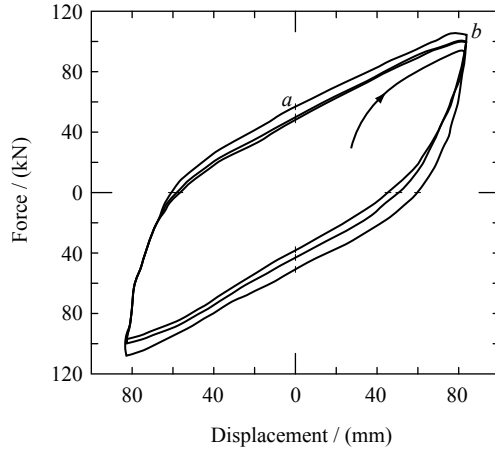

Figure 4. Force-displacement hysteresis loops for Waiotukupuna bearing with a vertical force of 350 kN, stroke of ± 85 mm and 0.9 Hz.

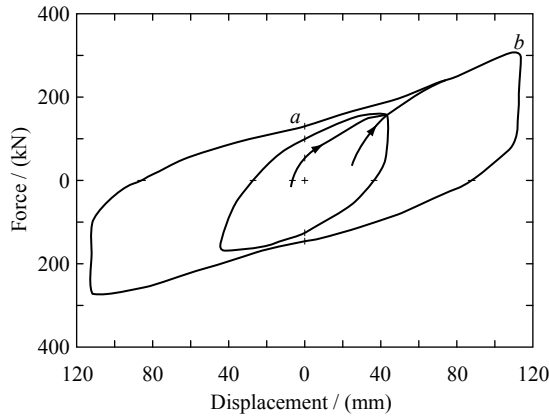

Figure 5. Force-displacement hysteresis loops for the Wm Clayton Building bearing at ± 45 and ± 110 mm with a vertical force of 3.15 MN at 0.9 Hz.

emphasized that the accuracy of these results is poor in that to obtain them it was necessary to subtract the force due to the PTFE bearings from the measured force and at small displacements these forces are comparable.

Thus a reasonable description of the hysteresis loop is a bilinear solid with an initial elastic stiffness $k_1 = 10k_r$ followed by a post yield stiffness $k_2 = k_r$.

(iii) Dependence on the diameter of the lead insert. The dependence of the hysteresis loop on the diameter of the lead insert was investigated by fitting the bearing 650 mm in diameter with a series of inserts from 50 to 170 mm in diameter (Table 1). As expected the important parameter is the cross sectional area of the lead, $A(\text{Pb})$. The variation with $A(\text{Pb})$ of the force at 'a', $F(a)$, and the maximum force $F(b)$ is shown in Figures 6 and 7. In the case of $F(b)$ it is more useful to plot $F(b) - F(r)$, where $F(r)$ is the force due to the rubber calculated from the bearing shear stiffness (k_r). Also included in these two

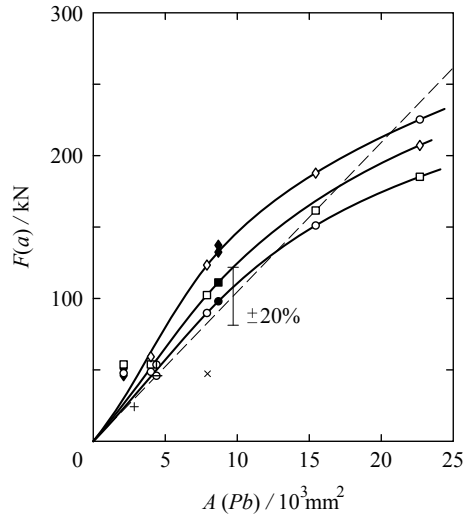

Figure 6. Dependence of force $F(a)$ on cross section area of lead insert. Vertical force \circ 1.05 MN, \square 2.10 MN, \diamond 3.15 MN, open points 650 mm diameter bearing, filled points Wm Clayton Building bearing. $+$ and \times 356 mm square bearing, Φ Waiotukupuna bearing and \emptyset Toe Toe bearing. Dashed line is for $\sigma(Pb) = 10.5$ MPa.

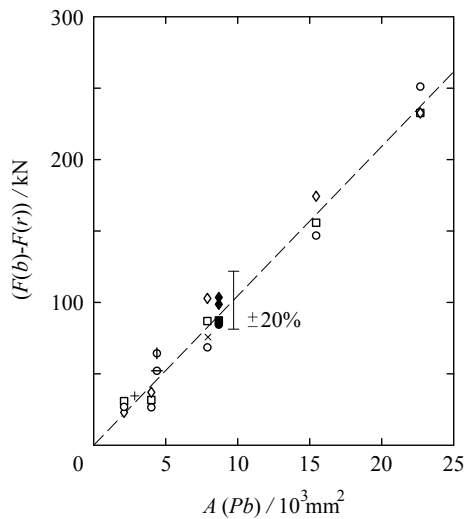

Figure 7. Variation of force $(F(b)-F(r))$ with cross section area of lead. Vertical force \circ 1.05 MN, \square 2.10 MN, \diamond 3.15 MN, open points 650 mm diameter bearing, filled points Wm Clayton Building bearing. $+$ and \times 356 mm square bearing, Φ Waiotukupuna bearing and \emptyset Toe Toe bearing. Dashed line is for $\sigma(Pb) = 10.5$ MPa.

figures are the results for all the dynamic tests conducted on the various lead rubber bearings for a shear strain, $\gamma = x(\max)/h$, of ~ 0.5 , where $x(\max)$ is the maximum displacement and h is the total height of the lead in the bearing.

Except for the Waitotukupuna results all the data in Figure 7 lie within ± 20 per cent of a straight line with a slope of 10.5 MPa. Therefore, to a good approximation

$$F(b) = \sigma(\text{Pb})A(\text{Pb}) + k_r x(\text{max}), \quad (1)$$

where $\sigma(\text{Pb}) = 10.5$ MPa, and $A(\text{Pb})$ is the cross sectional area of the lead insert.

The results for the dependence of $F(a)$ on $A(\text{Pb})$ are not so simple with the data following a curve rather than a straight line (Figure 6). However, if $\sigma(a)$, where

$$\sigma(a) = F(a)/A(\text{Pb}) \quad (2)$$

is plotted against the height to diameter ratio (h/d) of the lead insert, then $\sigma(a)$ is found to increase gradually with h/d and is also dependent on the vertical compressive stress applied to the bearing (Figure 8).

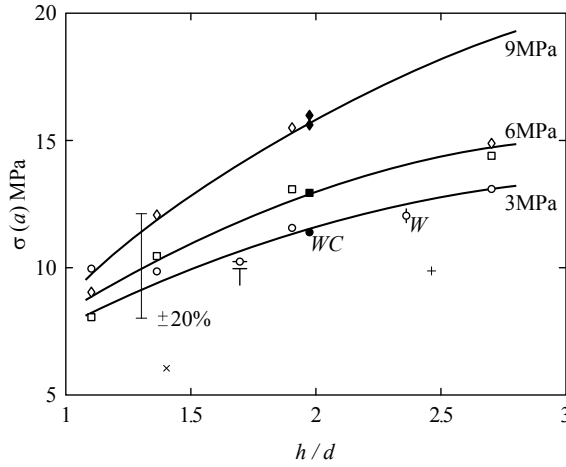

Figure 8. Dependence of lead yield stress, $\sigma(a)$, on the ratio of height to diameter of the lead for vertical stresses of 3, 6 and 9 MPa.

(iv) *Creep.* For a number of applications it is necessary to know the behaviour of the lead-rubber bearing under creep conditions. For example, if a bridge deck is mounted on the bearings then during the normal 24 hour cycle of temperature the bearings will have to accommodate $\sim \pm 3$ mm without producing large forces. To determine the effect of creep rates of ~ 1 mm/h the second lead-rubber bearing made, that is $356 \times 356 \times 140$ mm with a 100 mm lead plug, was mounted in the back to back reaction frame in the Instron (Figure 2). The first result was obtained at 6 mm/h with the force due to the lead alone reaching a maximum after 2.5 h before decreasing slowly. After 6 h the displacement was held constant and the force due to the lead decreased to one half in about one hour and continued to fall with time giving a relaxation time of 1 to 2 h. Another creep test was carried out at 1 mm/h for six hours when the direction was reversed giving the hysteresis shown in Figure 9. For completeness the force, $F(r)$, due to the rubber is included with its ± 20 per cent error bar. The shear stress in the lead plug reached a maximum of 3.2 MPa, which is ~ 30 per cent of the stress of 10.5 MPa for the dynamic tests.

Because of the large errors caused by $F(r)$ it was not possible to determine accurately the rate dependence of the lead in the lead-rubber bearing. To overcome this problem three lead hysteretic dampers,

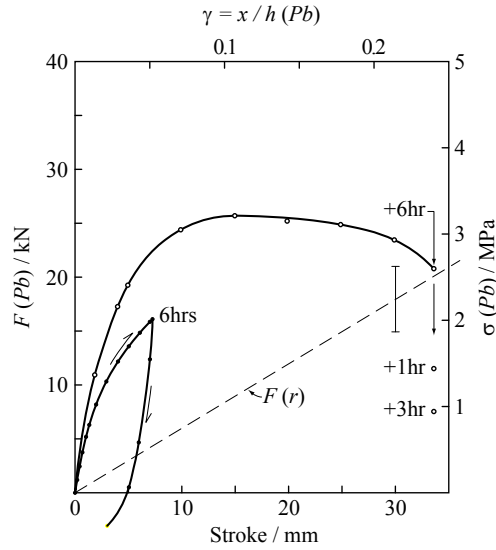

Figure 9. Force due to lead during creep of 356 mm square bearing with 100 mm diameter lead plug and vertical force of 400 kN. Open points 6 mm/h, filled 1 mm/h and dashed line is $F(r)$.

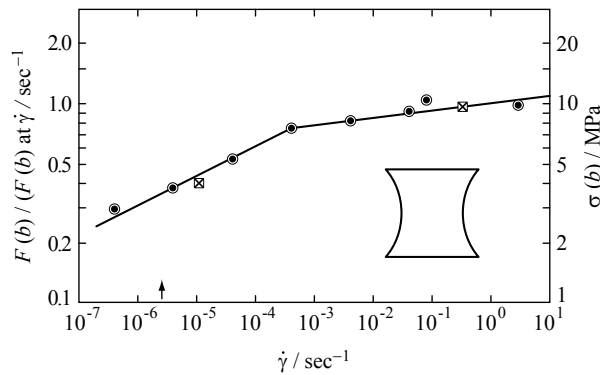

Figure 10. Creep dependence of lead in shear. Lead shear damper, 356 mm square bearing with 100 mm lead insert.

which were designed to operate in shear without a rubber bearing [Robinson 1975; Tucker and Robinson 1976] were tested at various strain rates. These dampers consisted of parabolic lead cylinders with their ends soldered to two brass plates (Figure 10). They were parabolically shaped to minimize the effect of the bending moments which occur away from the neutral axis of the lead during the application of simple shear; in fact to a first approximation the shear stress near the parabolic surface of the lead remained constant. The shear dampers were made with their height equal to waist diameter and had diameters of 24, 42 and 94 mm and nominal $\dot{\gamma} = 1 \text{ s}^{-1}$ forces of 8, 24 and 120 kN respectively. The rate dependence of these dampers, with their shear stress normalized to that at $\dot{\gamma} = 1 \text{ s}^{-1}$, is shown in Figure 10 together with the values obtained for the second lead rubber bearing at 10^{-5} and $3 \times 10^{-1} \text{ s}^{-1}$. These results

follow

$$\sigma(\text{Pb}) = a\dot{\gamma}^b \quad (3)$$

where below $\dot{\gamma} = 3 \times 10^{-4} \text{ s}^{-1}$, $b = 0.15$ and above, $b = 0.035$. For the lead extrusion damper [Robinson and Greenbank 1976] it was found that for the two regions $b = 0.12$ and 0.03 , values within the experimental error of the present work. For slow creep other authors conclude that $b = 0.13$ [Pearson 1944; Pugh 1970].

These results indicate that the lead-rubber bearing has little rate dependence at strain rates of $3 \times 10^{-4} \text{ s}^{-1}$ to 10 s^{-1} , which includes typical earthquake rates of 10^{-1} to 1 s^{-1} , and in fact in this region an increase of rate by a factor of ten causes an increase in force of only 8 per cent. Below strain rates of $4 \times 10^{-4} \text{ s}^{-1}$, the dependence of the shear stress on creep rate is greater, with a 40 per cent change in force for each decade change in rate. However, this means that at creep displacements of $\sim 1 \text{ mm/h}$ for a typical bearing 100 mm high, that is $\dot{\gamma} \sim 3 \times 10^{-6} \text{ s}^{-1}$, the shear stress has dropped to 35 per cent of its value at typical earthquake rates ($\dot{\gamma} \sim 1 \text{ s}^{-1}$).

(v) *Fatigue and temperature.* The lead-rubber bearing can be expected to survive a large number of earthquakes, each of which causes 3 to 5 excursions of $\sim 100 \text{ mm}$. For example, the results for a series of dynamic tests on the 650 mm diameter bearing with a 140 mm diameter lead plug are shown in Figure 11. $F(a)$ and $F(b)$ decreased by 10 and 25 per cent over the first five cycles but recovered some of this decrease in the five minute breaks between tests. An interval of 12 days between the last two tests did not give a greater recovery than that obtained in 5 minutes. The effect of the 24 cycles is shown more clearly in Figure 12 where the two hysteresis loops are the first and twenty-fourth. The area of the twenty-fourth loop is 80 per cent of the first, indicating that the bearing has retained most of its damping capacity over these five simulated earthquakes.

As a further check on the fatigue performance, the 356 mm bearing was dynamically tested at a shear strain of 0.5 for a total of 215 cycles in a two-day period. This bearing was also subject to 11 000 cycles

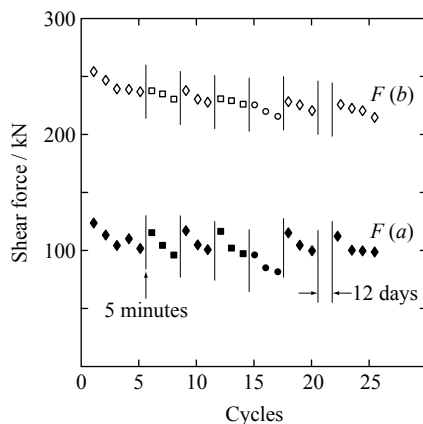

Figure 11. Variation of $F(a)$ (filled points) and $F(b)$ (open points) with number of cycles for 650 mm diameter bearing, 140 mm diameter lead insert, $\pm 91 \text{ mm}$ stroke and 0.9 Hz . \circ 1.05 MN, \square 2.10 MN, \diamond 3.15 MN.

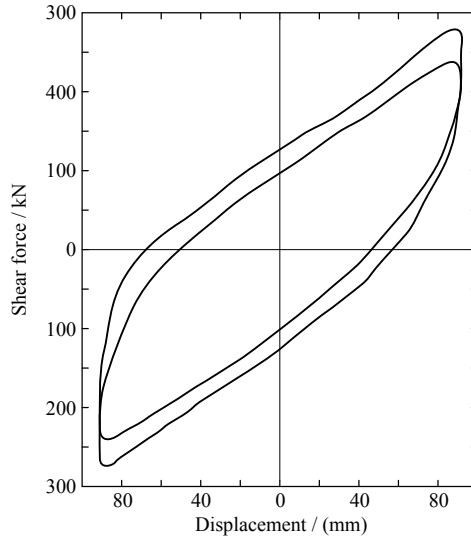

Figure 12. First (outer) and last (inner) hysteresis loops from Figure 11.

at ± 3 mm (0.9 Hz) to demonstrate that it could withstand the daily cycles of thermal expansion which occur in a bridge deck over a period of 30 years.

The 356 mm bearing was also studied with dynamic tests ($\dot{\gamma} \sim 0.5, 0.9$ Hz) at temperatures of -35 , -15 and $+45^\circ\text{C}$ to ensure its performance in extreme temperature environments. The ratio of the force $F(b)$ to that at 18°C for the first cycle was 1.4, 1.2 and 0.9 at -35 , -15 and $+45^\circ\text{C}$ respectively.

After both the fatigue and the temperature tests the lead-rubber bearing operated satisfactorily at 18°C . A more complete report of these and other tests is contained in [Robinson 1981].

Discussion

For strain rates of $\sim 1 \text{ s}^{-1}$ the lead-rubber hysteretic bearing can be treated as a bilinear solid with an initial shear stiffness of $\sim 10k_r$, and a post yield shear stiffness of k_r . The yield of the lead insert can be readily determined from the yield stress of the lead in the bearing of 10.5 MPa. Thus the maximum shear force for a given displacement is the sum of the elastic force of the elastomeric bearing and the plastic force required to deform the lead. The actual post yield stiffness is likely to vary by up to ± 40 per cent from k_r but will most likely be within ± 25 per cent of this value. The initial elastic stiffness has only been estimated from the experimental results and may in fact be in the range of $5k_r$, to $15k_r$. The prediction for the maximum force, $F(b)$, is more accurate and has instead an uncertainty of ± 20 per cent which is the same as expected for the uncertainty in the shear stiffness of manufactured elastomeric bearings. The actual area of the hysteresis loop formed by this bilinear model is approximately 20 per cent greater than the area of the measured hysteresis loop.

For most applications the ratio h/d should be greater than 1.5 but a value > 2 is more appropriate for light vertical loads. If the vertical load is light and h/d is close to one then the lead will not be sheared by the steel plates in the elastomeric bearing. Instead, at the edge of the hole, the steel plates will bend and the lead will deform into a ball which will provide very little damping. The manufactured bearings which were tested had h/d ratios of 1.7 and 2.4 (Table 1).



Figure 13. Wm Clayton Building as at March 1981

So far the lead-rubber hysteretic bearing has been used to base isolate three bridges and one building in New Zealand. The construction of the building was started in 1978 by the NZ Ministry of Works and is now nearing completion (Figure 13). This 97×40 m four-storey building with a reinforced concrete structure sits on eighty lead-rubber bearings manufactured by Empire Rubber Mills, Christchurch, N.Z. Each bearing carries a vertical load of 1 to 2 MN and is capable of taking a horizontal displacement of ± 200 mm. The bearing size and lead diameter were chosen after careful dynamic analysis using 1.5 times the El Centro 1940 earthquake (NS component) and the artificial A1 earthquake. [Meggett 1978] discusses this design in detail and concludes that for these two earthquakes shear displacements of 100 to 150 mm need to be accommodated while acceleration, inter-storey drifts and maximum base shear forces are approximately halved for the base-isolated system. He concludes that reasonable values for the shear stiffness of the elastomeric bearing and lead yield stress are

$$k_r = (1 \text{ to } 2)W \text{ m}^{-1} \quad (4)$$

and

$$F(\text{Pb}) = (0.05 \text{ to } 0.10)W \quad (5)$$

while in fact the bearings were measured with $k_r = 1.1W \text{ m}^{-1}$ and $F(b) = 0.07W$. In a further dynamic study of base-isolated multi-storey buildings [Lee and Medland 1981] concluded that for a bilinear hysteretic damper the effective period of the isolated structure is governed by the post yield stiffness of the isolation system and they give similar results to those obtained by Meggett for maximum displacement,

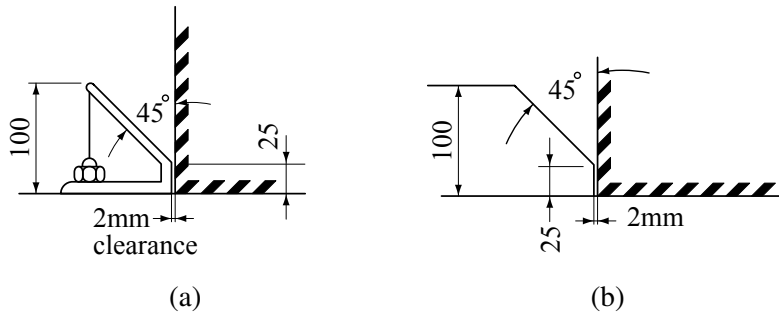

Figure 14. Possible details of the lead-rubber bearing at column footing. (a) On flat foundation and (b) in recess in foundation.

post yield stiffness and yield force. [Lee 1980] also studied the torsion reduction which occurs in asymmetric buildings which have been baseisolated and finds great reductions to twisting movements when the isolation system has properties similar to those determined by Meggett.

For base-isolated bridges, after careful dynamic analysis [Blakeley et al. 1980] give a range of parameters close to those summarized by Meggett and in fact chose for the Toe Toe Bridge an identical shear stiffness ($k_r = 1.1 W m^{-1}$) and a fractionally higher yield force ($F(Pb) = 0.08W$) to those for the Wm Clayton Building.

The lead-rubber bearings base isolating three bridges and one building which have been built are bolted to the structures and to the foundations. The disadvantage in this approach is that large vertical accelerations may cause damage to the bearing by the application of large tensile forces. Possibly a better method is to place the bearing in a recess in the structure and bolt the bearing to the foundation, or *vice versa* (Figure 14). With this arrangement, when there is uplift relative movements of 50 mm can be readily accommodated while even after larger vertical movements of up to 100 mm the bearing will be guided back into its place by the chamfered edges. This layout would satisfy the contention of some engineers that allowing uplift of columns of a building, particularly at corners, would make for relief of earthquake loadings.

Conclusions

- (i) The lead-rubber hysteretic bearing provides an economic solution to the problem of base isolating structures in that one unit provides the three functions of vertical support and horizontal flexibility via the rubber, and hysteretic damping by the plastic deformation of the lead.
- (ii) The lead-rubber hysteretic bearing behaves like a bilinear solid with an initial elastic shear stiffness, $k_1 \sim 10k_r$, a post elastic shear stiffness, $k_2 = k_r$, with the yield force being determined by the shear stress at which the lead in the bearing yields. This shear stress is found to be 10.5 MPa. The area of the measured hysteresis loop is found to be ~ 80 per cent of the loop defined by the bilinear solid model.
- (iii) A total of eleven lead-rubber bearings has been tested at strokes as high as ± 110 mm for three to 75 cycles at ~ 0.9 Hz. These bearings performed well under what is equivalent to strong earthquakes

attacking a base-isolated structure. Other more extreme dynamic tests include cycling at -35 and $+45^{\circ}\text{C}$ and 11 000 cycles at ± 3 mm.

- (iv) The results at shear strain rates of 3×10^{-7} to 3 s^{-1} show that at rates expected during an earthquake ($\sim 1 \text{ s}^{-1}$) the lead-rubber bearing has very little rate dependence while at rates expected during thermal expansion ($\sim 3 \times 10^{-6} \text{ s}^{-1}$) the shear stress is more strongly rate dependent.
- (v) The lead-rubber hysteretic bearing has been used to base isolate three bridges and one building in New Zealand and possibly is the most economic base isolation system available at present.

Acknowledgements

The 650 mm diameter elastomeric bearings were supplied by the New Zealand Ministry of Works and Development.

References

- [Birchenell 1959] C. E. Birchenell, *Physical metallurgy*, McGraw-Hill, London, 1959.
- [Blakeley et al. 1980] R. W. G. Blakeley, L. G. Cormack, and M. J. Stockwell, "Mechanical energy dissipation devices", *Bull. N.Z. Natl. Soc. Earthquake Eng.* **13** (1980), 264–268.
- [Lee 1980] D. M. Lee, "Base isolation for torsion reduction in asymmetric structures under earthquake loading", *Earthquake Eng. Struct. Dyn.* **8**:4 (1980), 349–359.
- [Lee and Medland 1981] D. M. Lee and I. C. Medland, "Base isolation systems for earthquake protection of multi-storey shear structures", *Earthquake Eng. Struct. Dyn.* **7** (1981), 555–568.
- [Meggett 1978] L. M. Meggett, "Analysis and design of a base-isolated reinforced concrete frame building", *Bull. N.Z. Natl. Soc. Earthquake Eng.* **11** (1978), 245–254.
- [Pearson 1944] C. E. Pearson, *The extrusion of metals*, Wiley, New York, 1944.
- [Pugh 1970] H. L. D. Pugh, "Hydrostatic extrusion", in *Mechanical behaviour of materials under pressure*, edited by H. L. D. Pugh, Applied Science, London, 1970.
- [Robinson 1975] W. H. Robinson, New Zealand patent 178949, 14 October 1975. Also U.S. patent 4117637 ("Cyclic shear energy absorber") and Japan patent 49609/77.
- [Robinson 1981] W. H. Robinson, "Lead rubber hysteretic bearings suitable for protecting structures during earthquakes", PEL Report 715, 1981.
- [Robinson and Greenbank 1975] W. H. Robinson and L. R. Greenbank, "Properties of an extrusion energy absorber", *Bull. N.Z. Natl. Soc. Earthquake Eng.* **8** (1975), 287–291.
- [Robinson and Greenbank 1976] W. H. Robinson and L. R. Greenbank, "An extrusion energy absorber suitable for the protection of structures during an earthquake", *Earthquake Eng. Struct. Dyn.* **4**:3 (1976), 251–259.
- [Robinson and Tucker 1977] W. H. Robinson and A. G. Tucker, "A lead-rubber shear damper", *Bull. N.Z. Natl. Soc. Earthquake Eng.* **10** (1977), 151–153.
- [Robinson and Tucker 1983] W. H. Robinson and A. G. Tucker, "Test results for lead-rubber bearings for the William M. Clayton Building, Toe Toe Bridge and Waitokupuna Bridge", *Bull. N.Z. Natl. Soc. Earthquake Eng.* **14**:1 (1983), 21–33.
- [Skinner and McVerry 1975] R. I. Skinner and G. H. McVerry, "Base isolation for increased earthquake resistance of buildings", *Bull. N.Z. Natl. Soc. Earthquake Eng.* **8** (1975), 93–101.
- [Skinner et al. 1975a] R. I. Skinner, J. L. Beck, and G. N. Bycroft, "A practical system for isolating structures from earthquake attack", *Earthquake Eng. Struct. Dyn.* **3**:3 (1975), 297–309.
- [Skinner et al. 1975b] R. I. Skinner, J. M. Kelly, and A. J. Heine, "Hysteretic dampers for earthquake-resistant structures", *Earthquake Eng. Struct. Dyn.* **3** (1975), 287–296.

- [Skinner et al. 1980] R. I. Skinner, R. G. Tyler, A. J. Heine, and W. H. Robinson, “Hysteretic dampers for the protection of structures from earthquakes”, *Bull. N.Z. Natl. Soc. Earthquake Eng.* **13** (1980), 22–36.
- [Tucker and Robinson 1976] A. G. Tucker and W. H. Robinson, “Shear energy absorbers”, PEL Report 518, 1976.
- [Tyler 1977] R. G. Tyler, “Dynamic tests on PTFE sliding layers under earthquake conditions”, *Bull. N.Z. Natl. Soc. Earthquake Eng.* **10** (1977), 129–138.
- [Wulff et al. 1956] J. Wulff, J. F. Taylor, and A. J. Shayler, *Metallurgy for engineers*, Wiley, New York, 1956.

Received 22 May 1981. Revised 2 Nov 1981.

WILLIAM H. ROBINSON: *Physics and Engineering Laboratory, Department of Scientific and Industrial Research, Lower Hutt, New Zealand*

SEISMIC ISOLATION AND PROTECTIVE SYSTEMS

pjm.math.berkeley.edu/siaps

EDITOR-IN-CHIEF

GAINMARIO BENZONI University of California, San Diego, USA

ASSOCIATE EDITORS

JAMES M. KELLY University of California, Berkeley, USA
DAVID WHITTAKER Technical Director of Structural Engineering, Beca, New Zealand
MUSTAFA ERDIK Bogazici University, Istanbul, Turkey

ADDITIONAL EDITORIAL BOARD MEMBERS

MASSIMO FORNI ENEA, Italy
KEITH FULLER Consultant, United Kingdom
ALESSANDRO MARTELLI ENEA, Italy

PRODUCTION

SILVIO LEVY Scientific Editor

See inside back cover or <http://pjm.math.berkeley.edu/siaps/> for submission guidelines.

SIAPS (ISSN 2150–7902) is published in electronic form only. The subscription price for 2011 is US \$150/year. Subscriptions, requests for back issues, and changes of address should be sent to Mathematical Sciences Publishers, Department of Mathematics, University of California, Berkeley, CA 94720–3840.

SIAPS peer-review and production is managed by EditFlow™ from Mathematical Sciences Publishers.

PUBLISHED BY

 **mathematical sciences publishers**
<http://msp.org/>

A NON-PROFIT CORPORATION

Typeset in L^AT_EX

©Copyright 2011 by Mathematical Sciences Publishers

<i>A tribute to Dr. William H. (Bill) Robinson</i> Bill Robinson	1
<i>Lead-rubber hysteretic bearings suitable for protecting structures during earthquakes</i> William H. Robinson	5
<i>The use of tests on high-shape-factor bearings to estimate the bulk modulus of natural rubber</i> James M. Kelly and Jiun-Wei Lai	21
<i>Passive damping devices for earthquake protection of bridges and buildings</i> Christian Meinhardt, Daniel Siepe and Peter Nawrotzki	35
<i>Report on the effects of seismic isolation methods from the 2011 Tohoku–Pacific earthquake</i> Yutaka Nakamura, Tetsuya Hanzawa, Masanobu Hasebe, Keiichi Okada, Mika Kaneko and Masaaki Saruta	57
<i>An experimental model of buckling restrained braces for multi-performance optimum design</i> Noemi Bonessio, Giuseppe Lomiento and Gianmario Benzoni	75